

Appendix 1 - Recession plane and containment angle diagrams

Updated 29 January 2015

Appendix 1. Recession plane and containment angle diagrams

(a) Recession planes

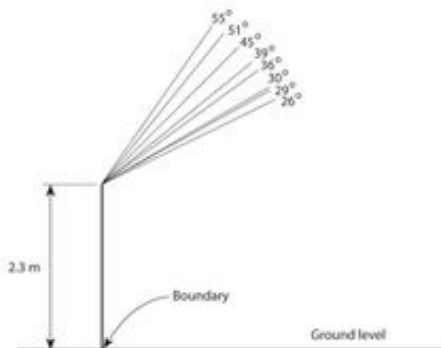

Applicable to all buildings in living zones (except LHB (Worsleys Spur), L3, L4B and L4C Zones) and all buildings in adjoining zones.

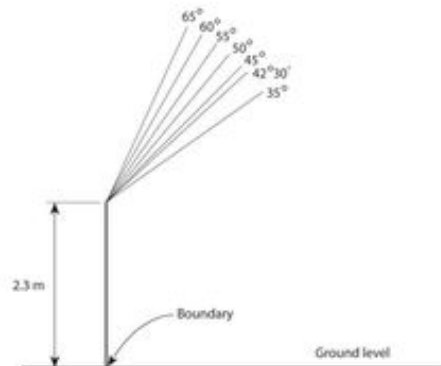

Applicable to all buildings in L3, L4B and L4C Zones and all buildings in adjoining zones.

Date: 17/4/2008

New Diagram - Appendix 1. Recession plane and containment angle diagrams

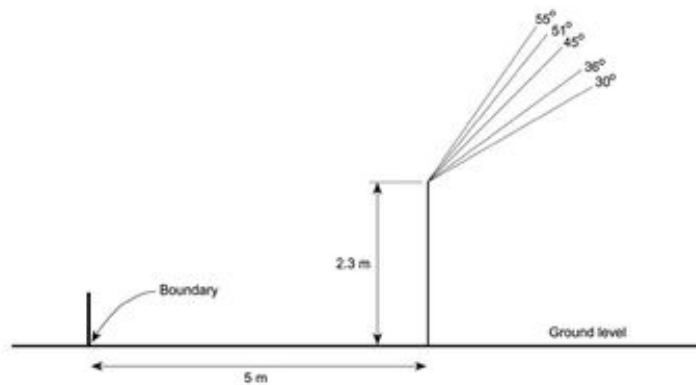

Applicable to all buildings in the Living HB (Worsleys Spur) zone.

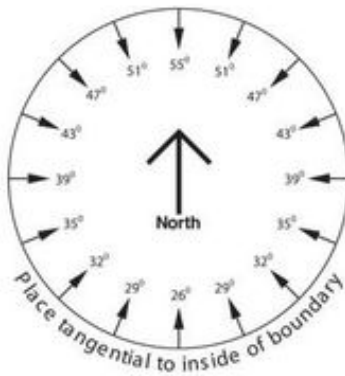

A Applicable to all buildings:

- in the L1, L1A, L1B, L1D and L1E zones
- on sites in other (non-living) zones that adjoin the L1, L1A, L1B, L1D and L1E zones.

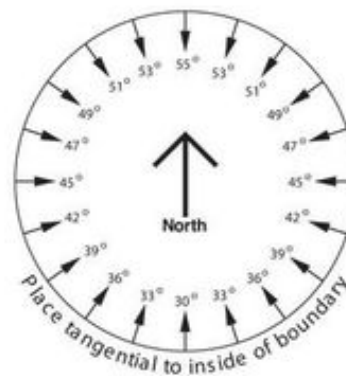

B Applicable to all buildings:

- in the LH, L2, LRS and LRV zones
- on sites in other (non-living) zones that adjoin the LH, L2, LRS and LRV zones.

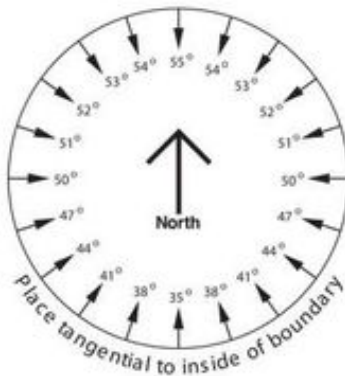

C Applicable to all buildings:

- in the L3 zone
- on sites in other (non-living) zones that adjoin the L3 zone
- in the Living 5 Zone (Riccarton, Kilmarnock and Raceway only)
- on sites in other (non-living) zones that adjoin the Living 5 Zone (Riccarton, Kilmarnock and Raceway only).

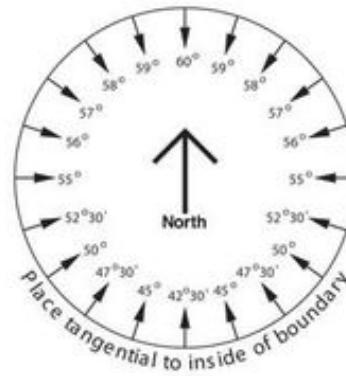

D Applicable to all buildings:

- in the L4C zone
- on sites in other (non-living) zones that adjoin the L4C zone
- in the L4B zones (except those buildings over 11 metres in height)
- on sites in other (non-living) zones that adjoin the L4B zones (except those buildings over 11 metres in height)
- in the Living 5 Zone (Peterborough only)
- on sites in other (non-living) zones that adjoin the Living 5 Zone (Peterborough only).

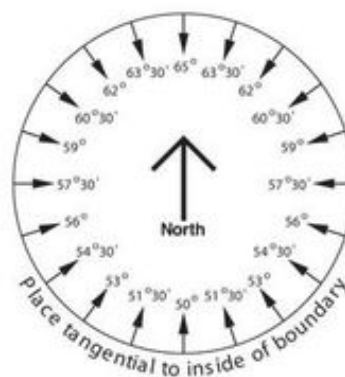

E Applicable to all buildings:

- over 11 metres in height in the L4B zones
- over 11 metres in height on sites in other (non-living) zones that adjoin the L4B zones.
- in the Living 5 Zone (Avon, Latimer, Peterborough and Montreal)
- on sites in other (non-living) zones that adjoin the Living 5 Zone (Avon, Latimer, Peterborough and Montreal)
- in the Central City Residential Zone

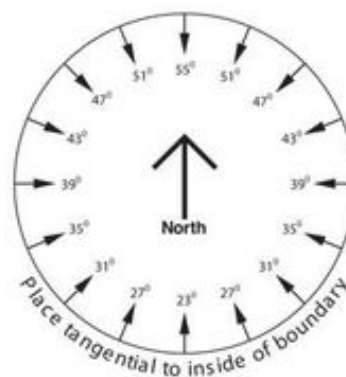

F Applicable to all buildings:

- in the LHA, LHB and TMB zones
- on sites in other (non-living) zones that adjoin the LHA, LHB and TMB zones,
- in the Living 5 Zone (Merivale, Papanui, Memorial Avenue, Shirley, Upper Riccarton and Russley only)
- on sites in other (non-living) zones that adjoin the Living 5 Zone (Merivale, Papanui, Memorial Avenue, Shirley, Upper Riccarton and Russley only)

Note: North is true north

Appendix 1 Gable end diagrams and recession planes

(c) Gable end diagrams: Where to measure a gable end

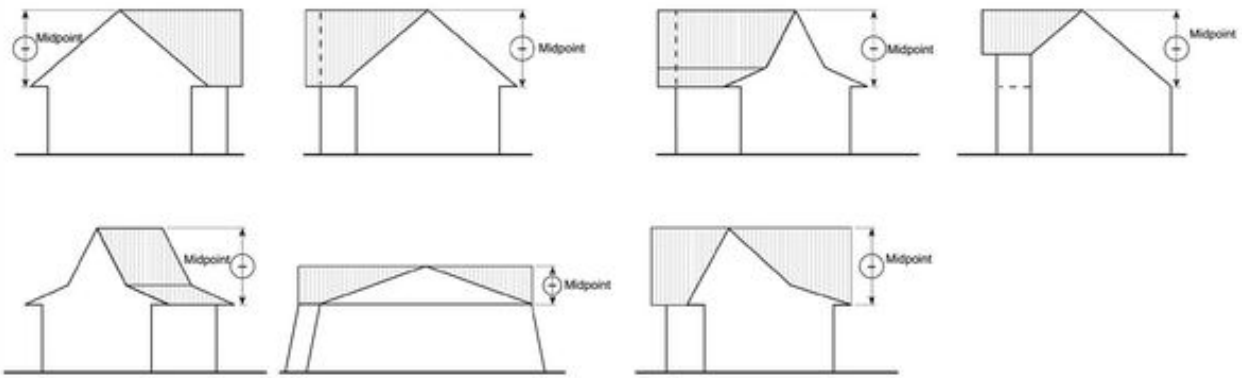

Examples of designs that do not meet the definition of a gable:

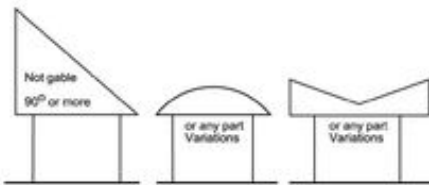

Location of mid-point gable:

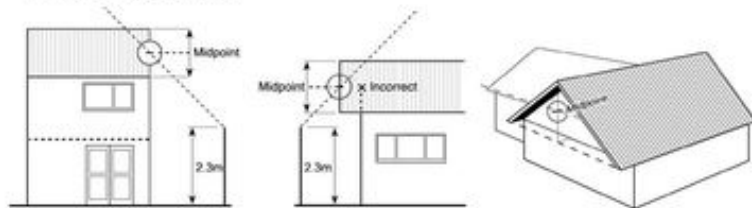

Appendix 1A - Continuous Building Length

Updated 14 November 2005

Appendix 1A – Continuous Building Length

A. Measurement of Ridgelines

Example 1.

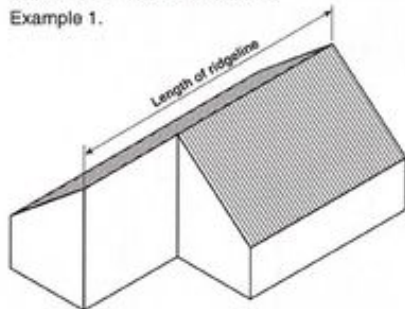

Not to Scale

Example 3.

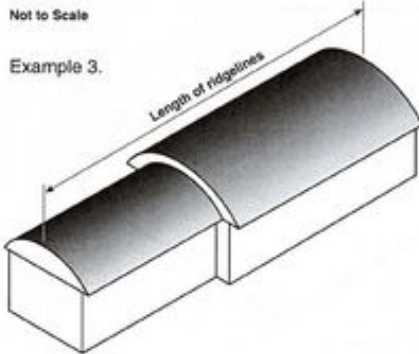

Not to Scale

Example 2.

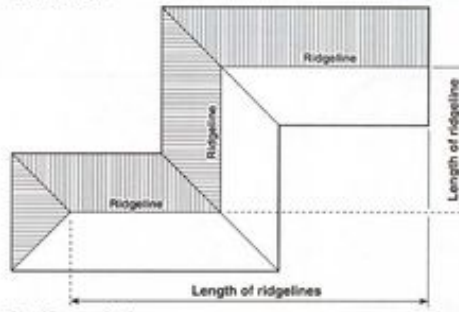

Plan View- roof only
Not to Scale

Appendix 1A Continuous building length

B. Measurement of Steps in Exterior Walls

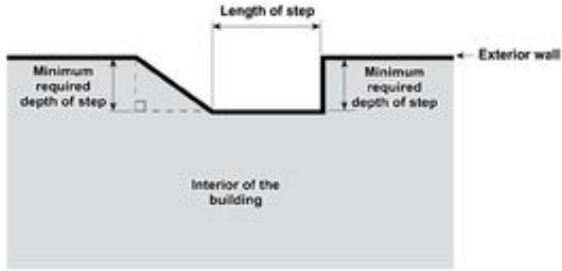

Plan View - Not to Scale

C. Measurement of Exterior Walls

Example 1.

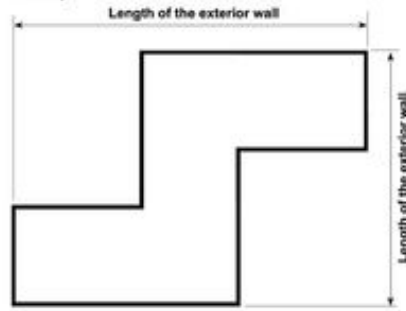

Example 2.

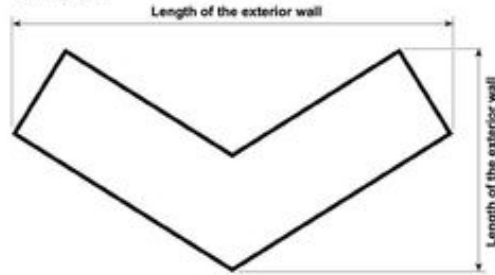

Plan View - exterior wall only
Not to Scale

Appendix 2 - Riverlea Estates

Updated 14 November 2005

Appendix 2. Riverlea Estates (Part 2 Living Zones)

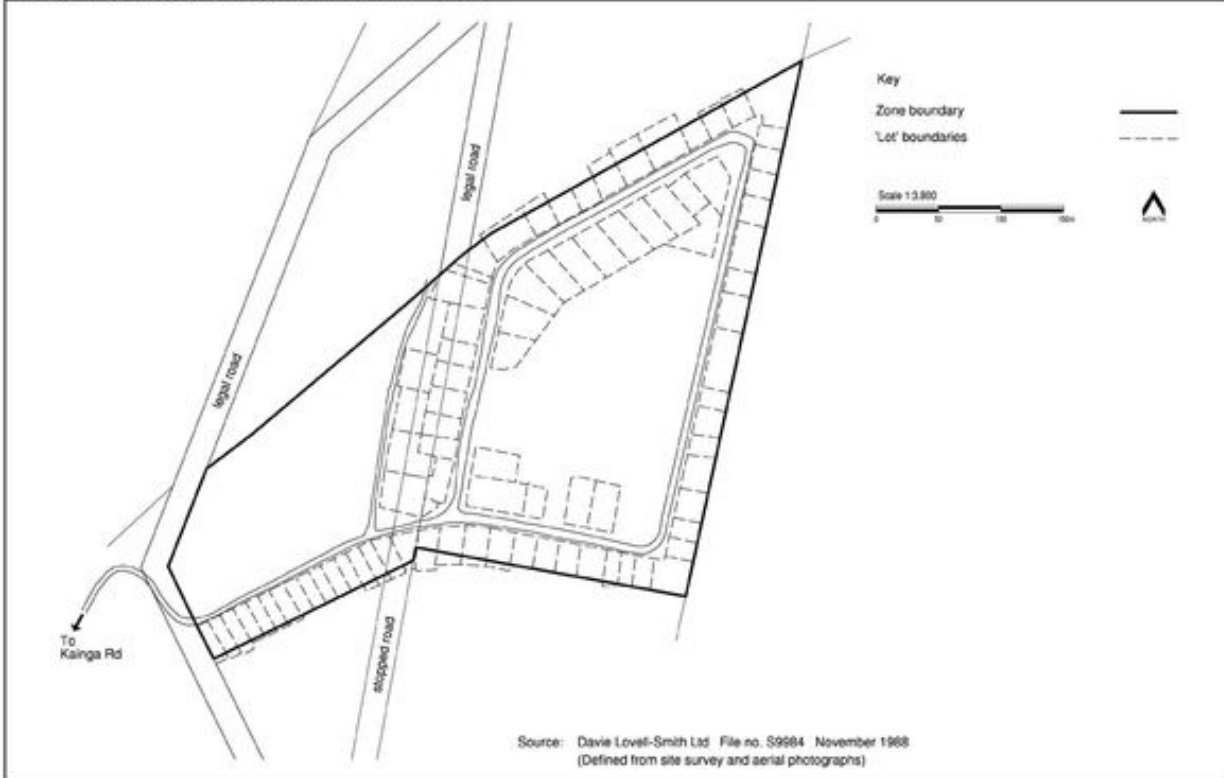

Appendix 3a - Development plan (Tulett)

Appendix 3a. Development plan (Tulett)

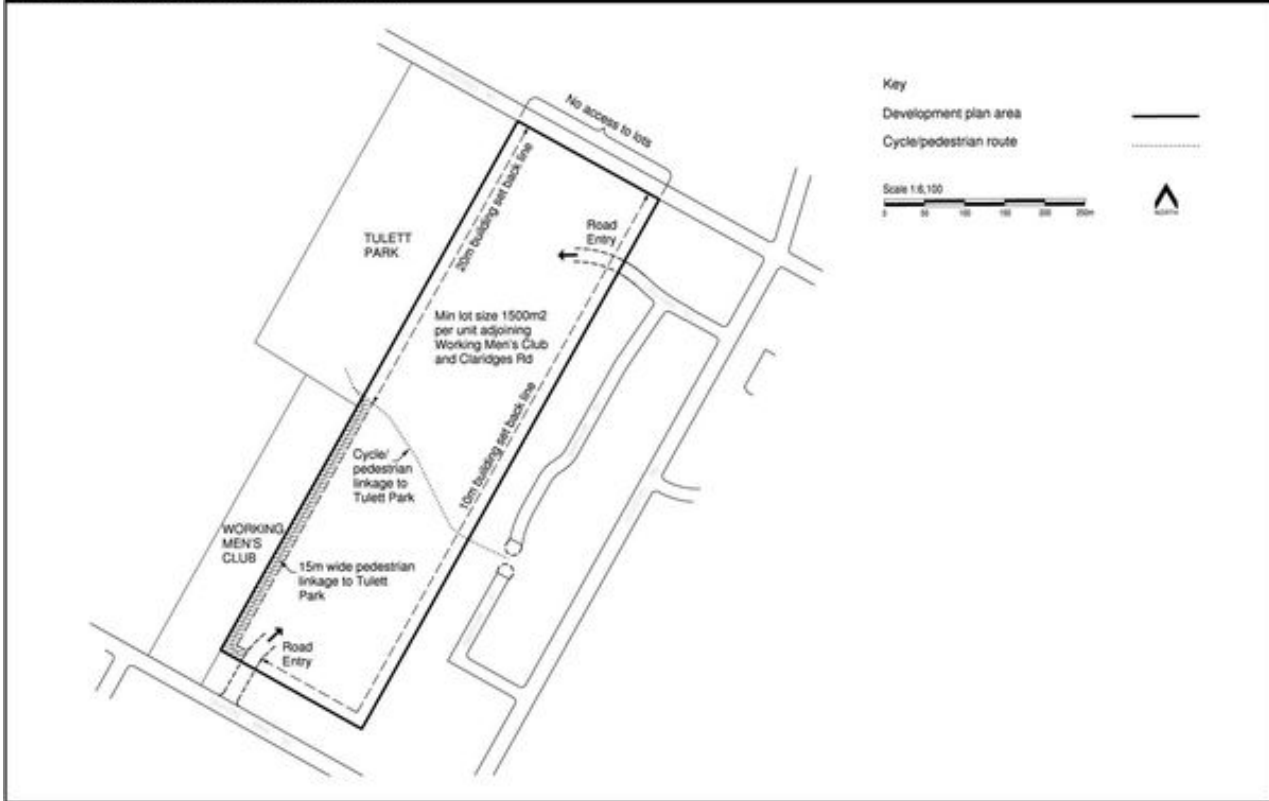

Appendix 3b - Development plan (Nunweek)

Appendix 3b. Development plan (Nunweek)

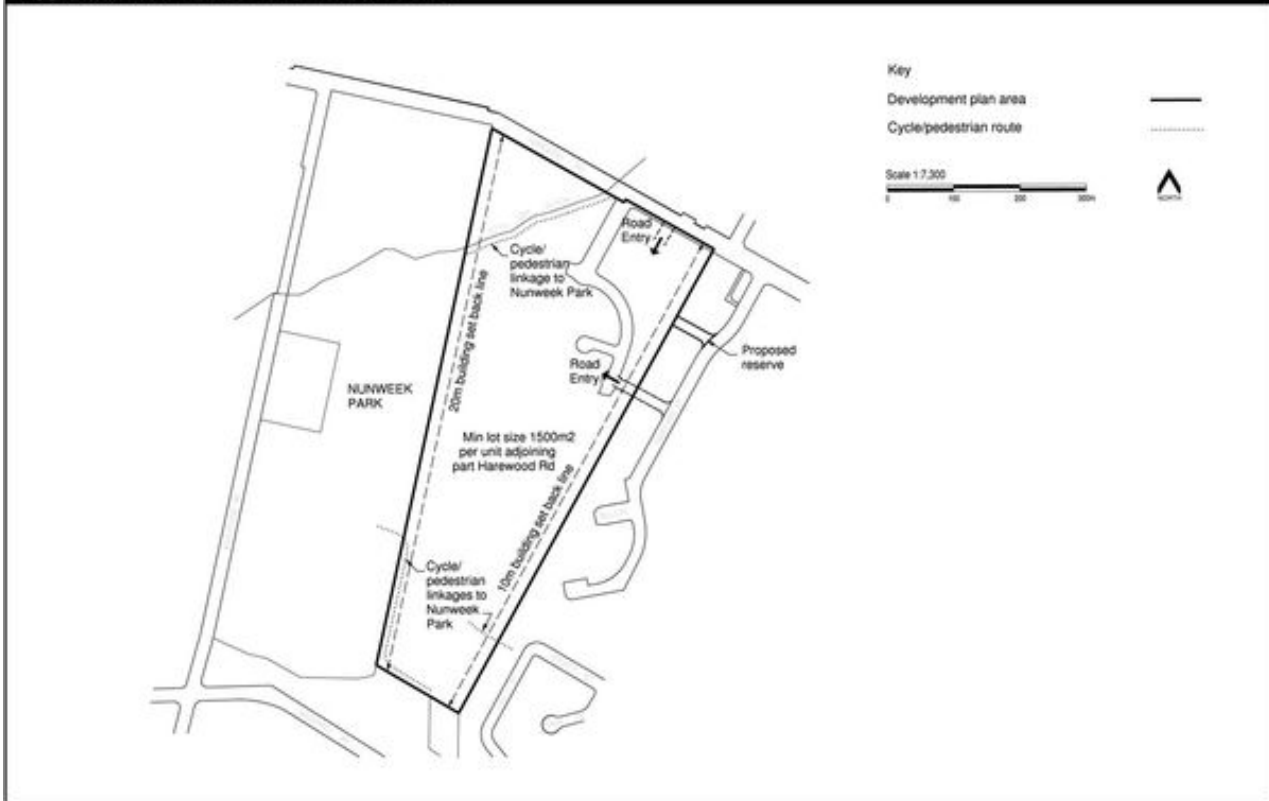

Appendix 3c - Development plan (Mairehau)

Appendix 3c - Development plan (Mairehau)

Appendix 3c. Development plan (Mairehau)

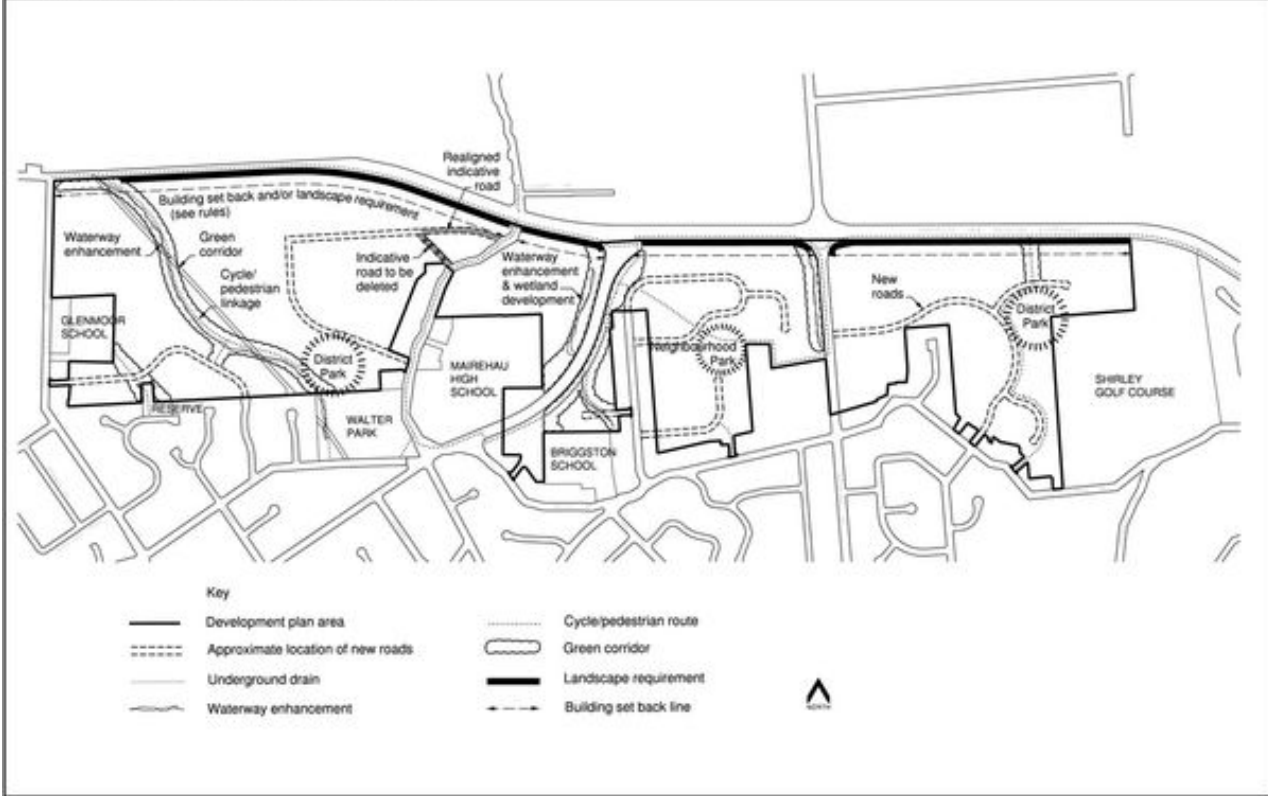

Appendix 3d - Development plan (Upper Kennedy's Bush)

Updated 14 November 2005

Appendix 3d. Development plan (Upper Kennedy's Bush)

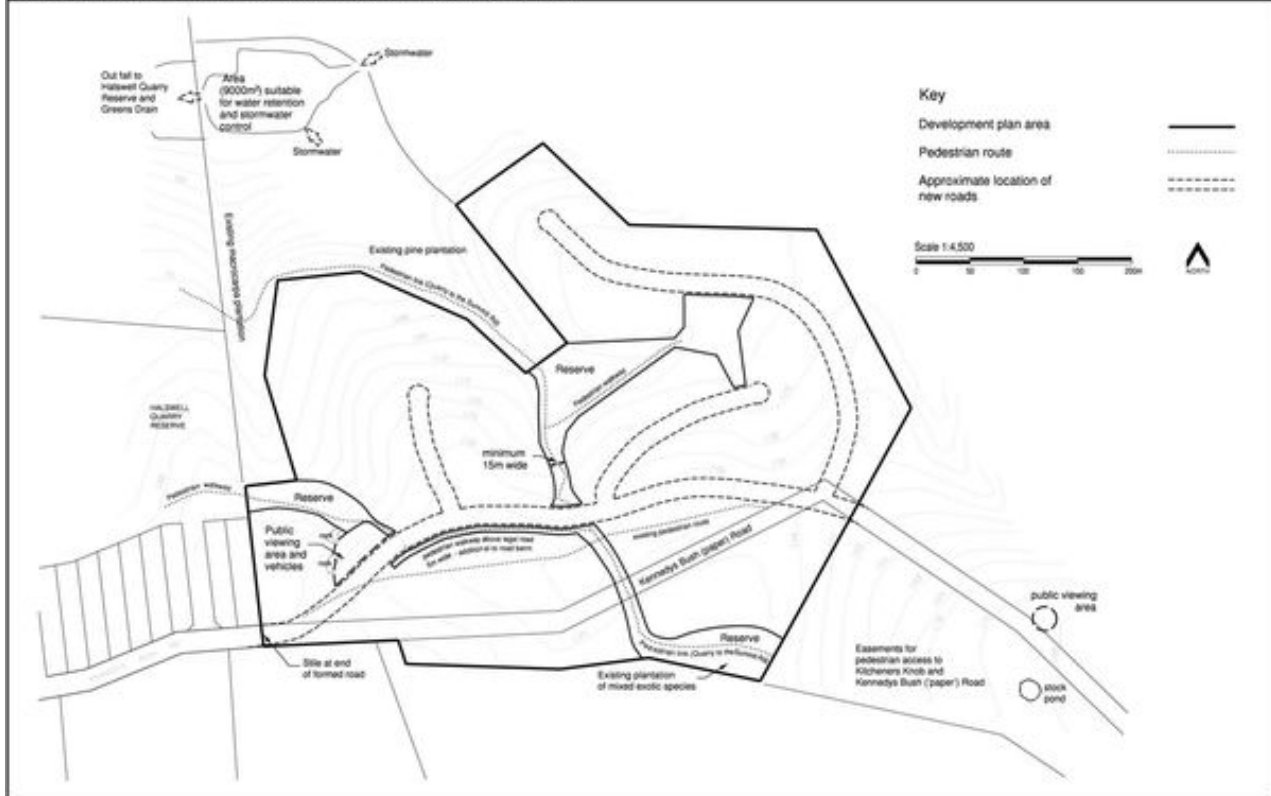

Appendix 3e - Development Plan - Living 1F Zone (Retirement Village - Prestons Road)

New Appendix 3e - Development Plan - Living 1F Zone (Retirement Village - Prestons Road)

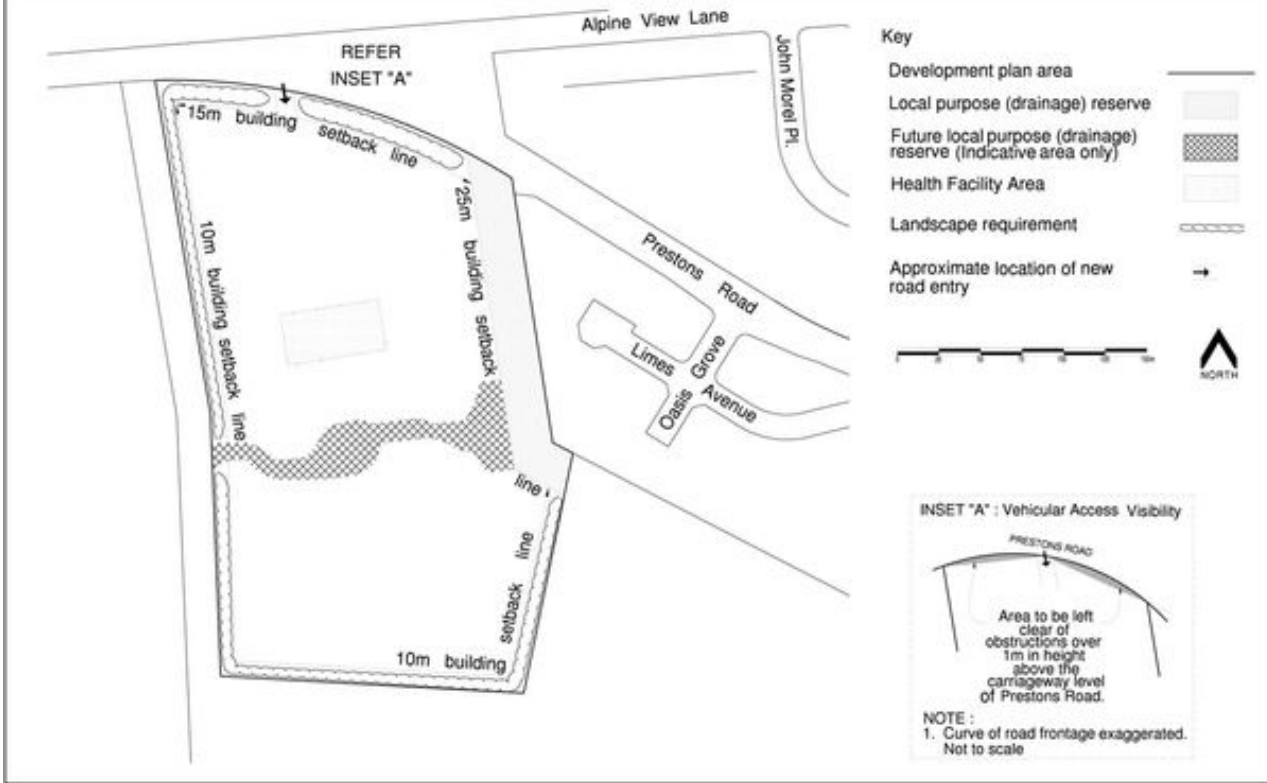

Appendix 3f - Development plan (Styx)

Updated 31 January 2010

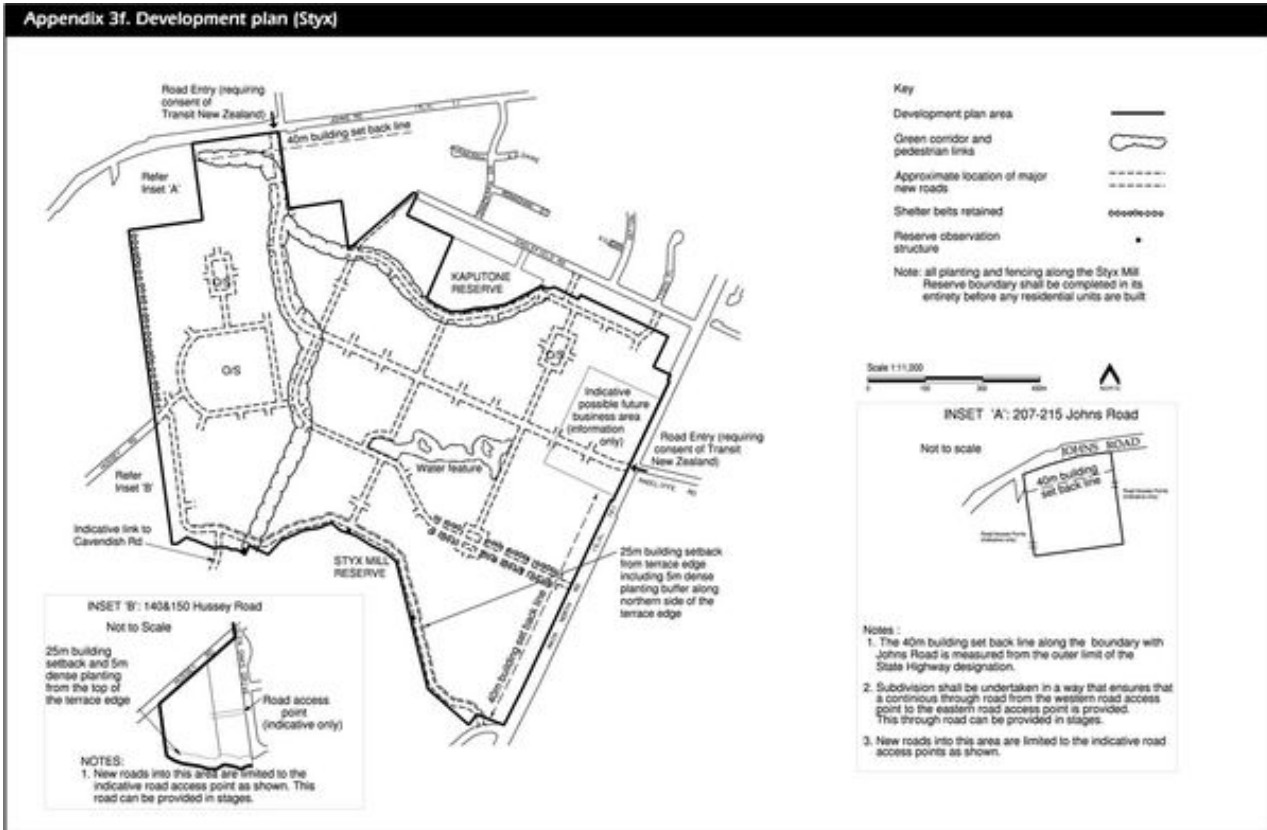

Appendix 3g - Development plan (East Halswell)

Updated 14 November 2005

Appendix 3g. Development plan - (East Halswell)

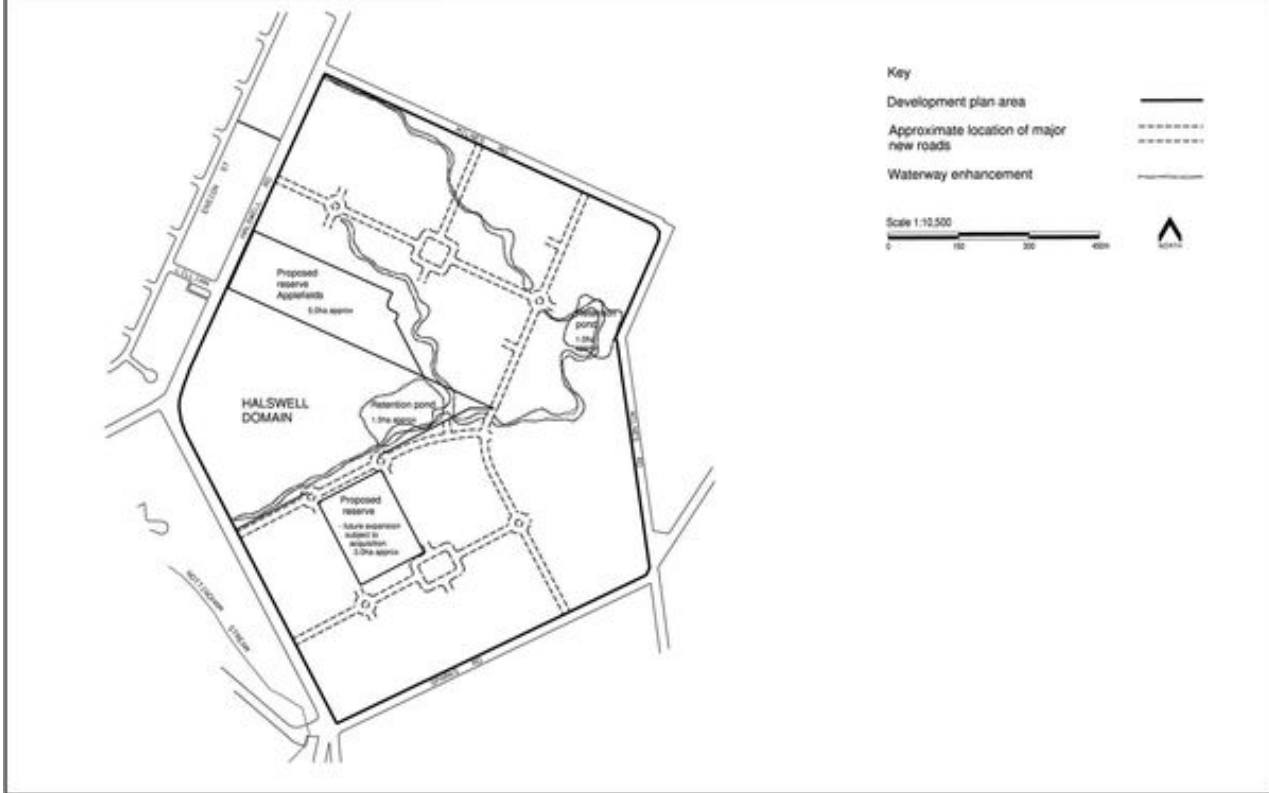

Appendix 3h - Development plan (North Halswell)

Updated 14 November 2005

Appendix 3h. Development plan (North Halswell)

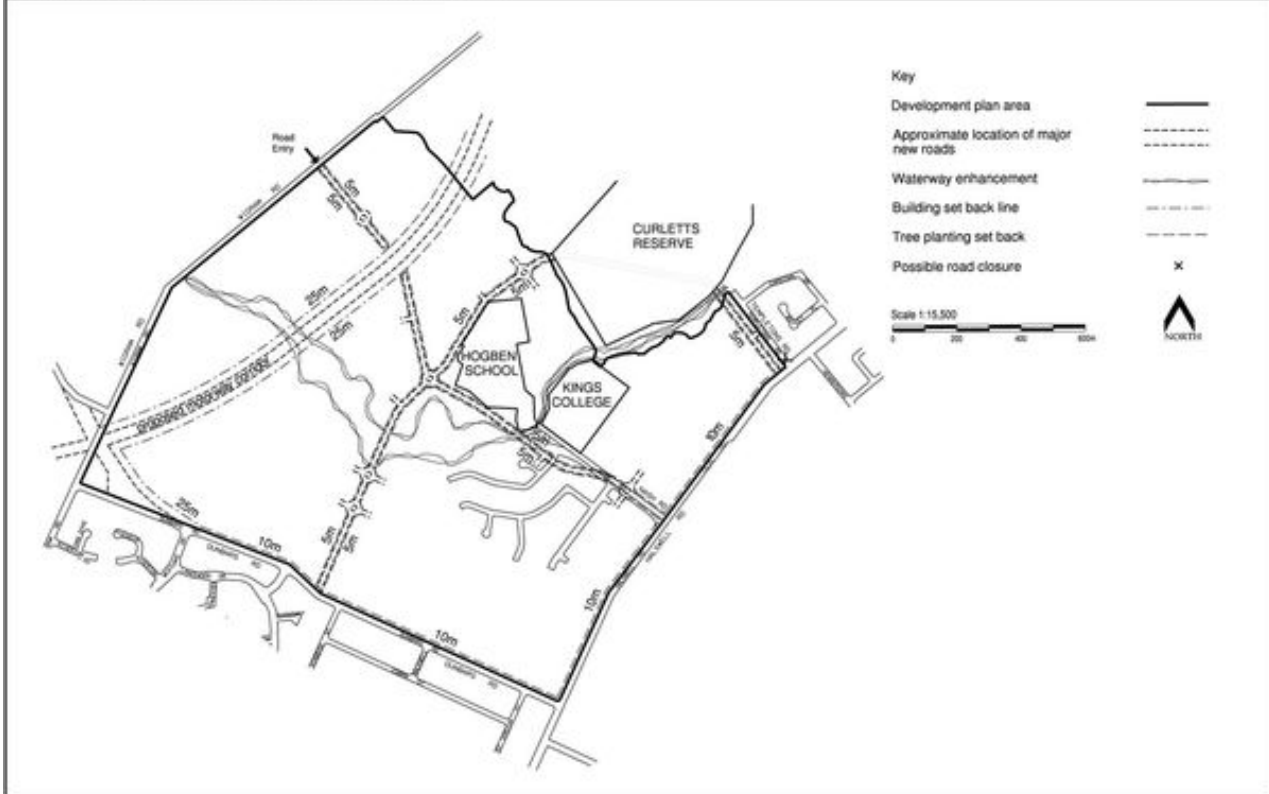

Appendix 3i - Cashmere and Worsleys

Updated 16 November 2009

Appendix 3i - Cashmere and Worsleys

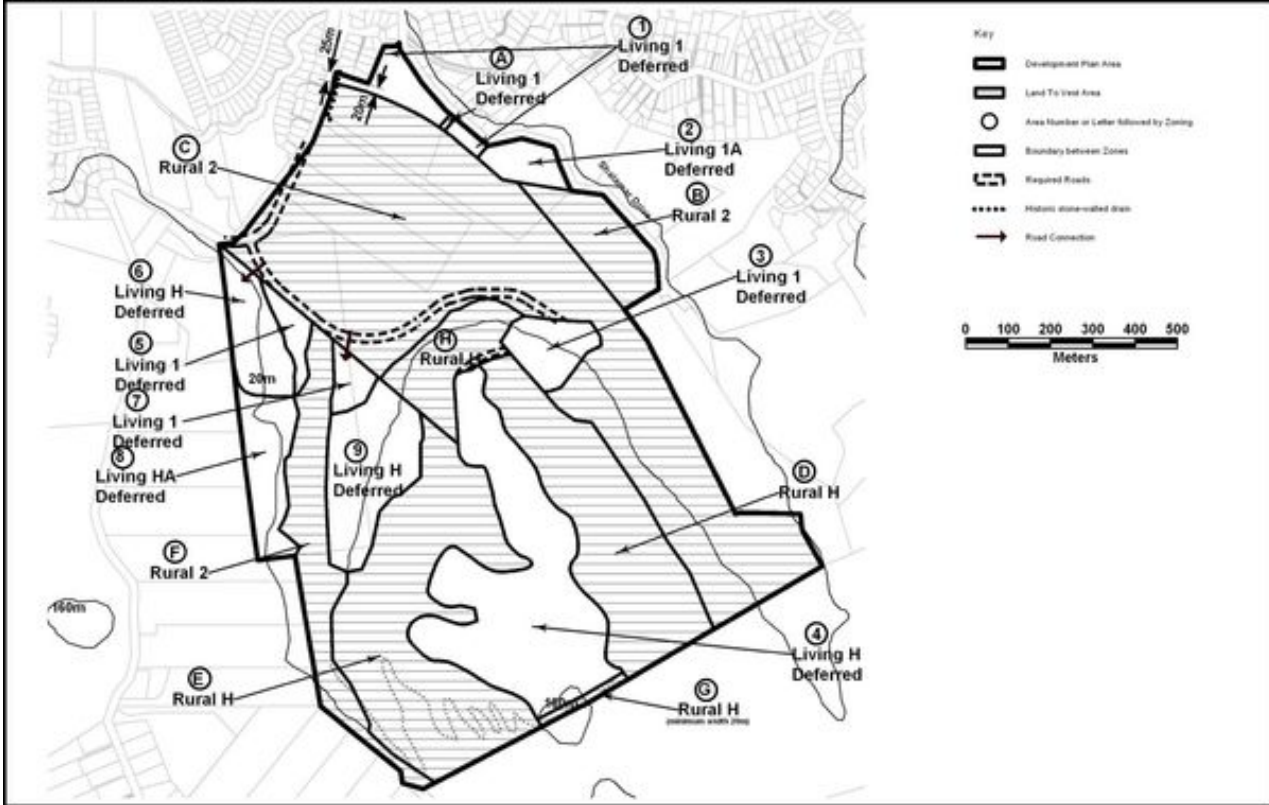

Appendix 3j - Development plan (Bridle Path Road)

Updated 14 November 2005

Appendix 3j - Development plan (Bridle Path Road)

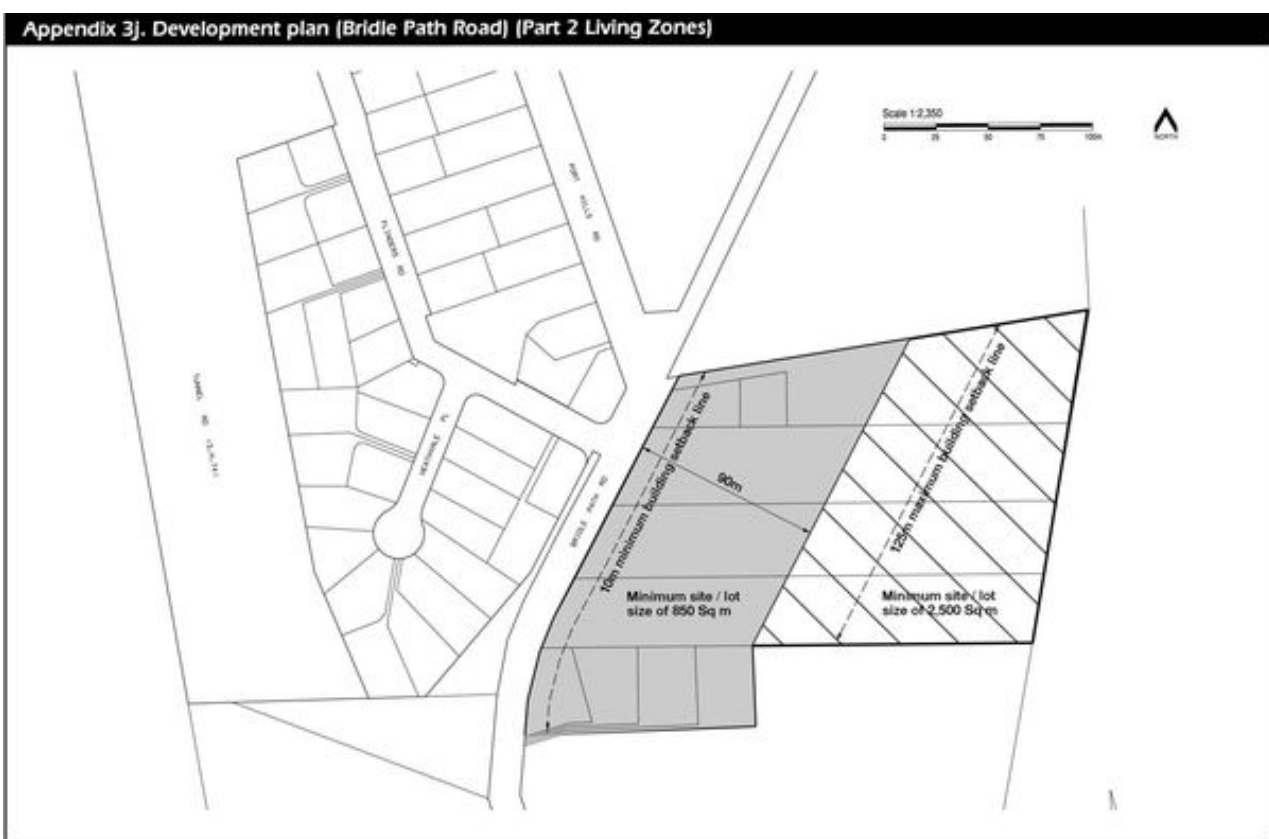

Appendix 3k - Development plan (Living Taylors Mistake Bach Zone)

Updated 14 November 2005

Appendix 3k. Development plan (Living Taylors Mistake Bach Zone)

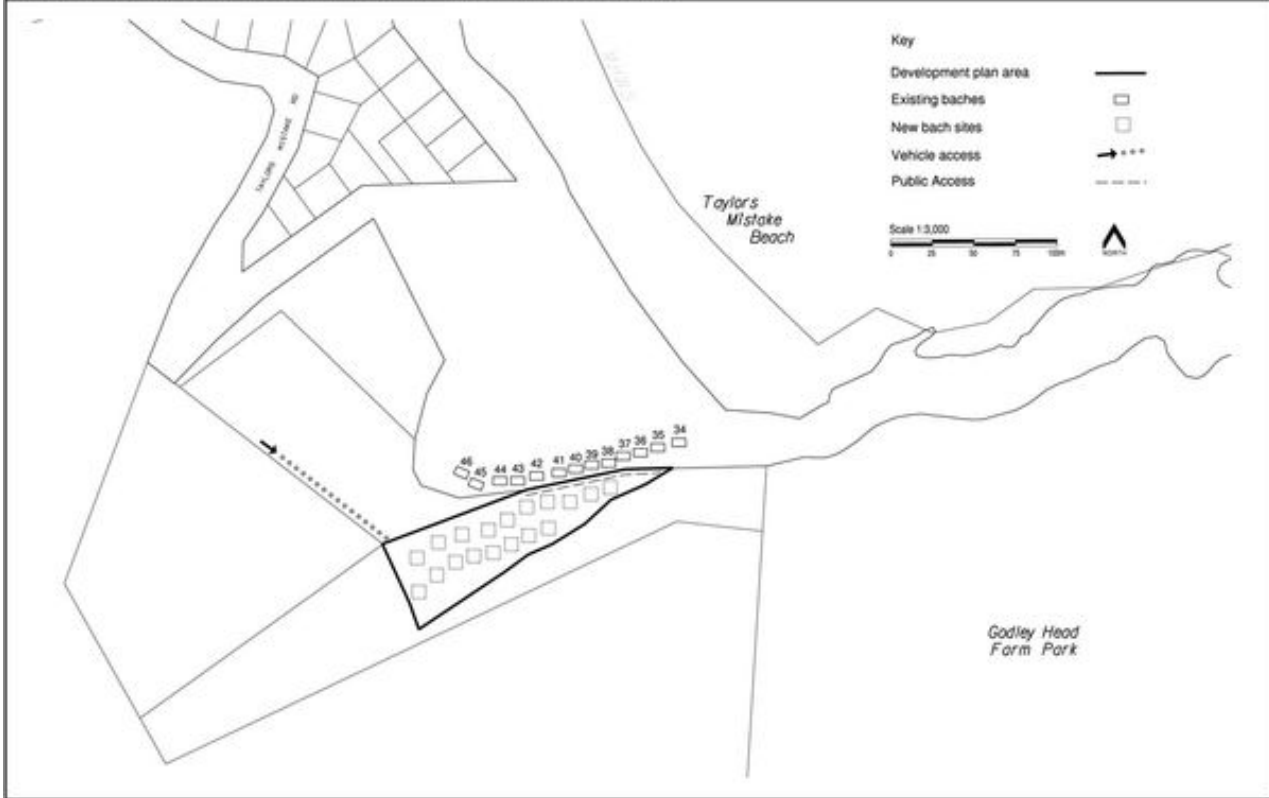

Appendix 3l - Development plan (Heathcote Village)

Updated 14 November 2005

Appendix 3l. Development plan (Heathcote Village)

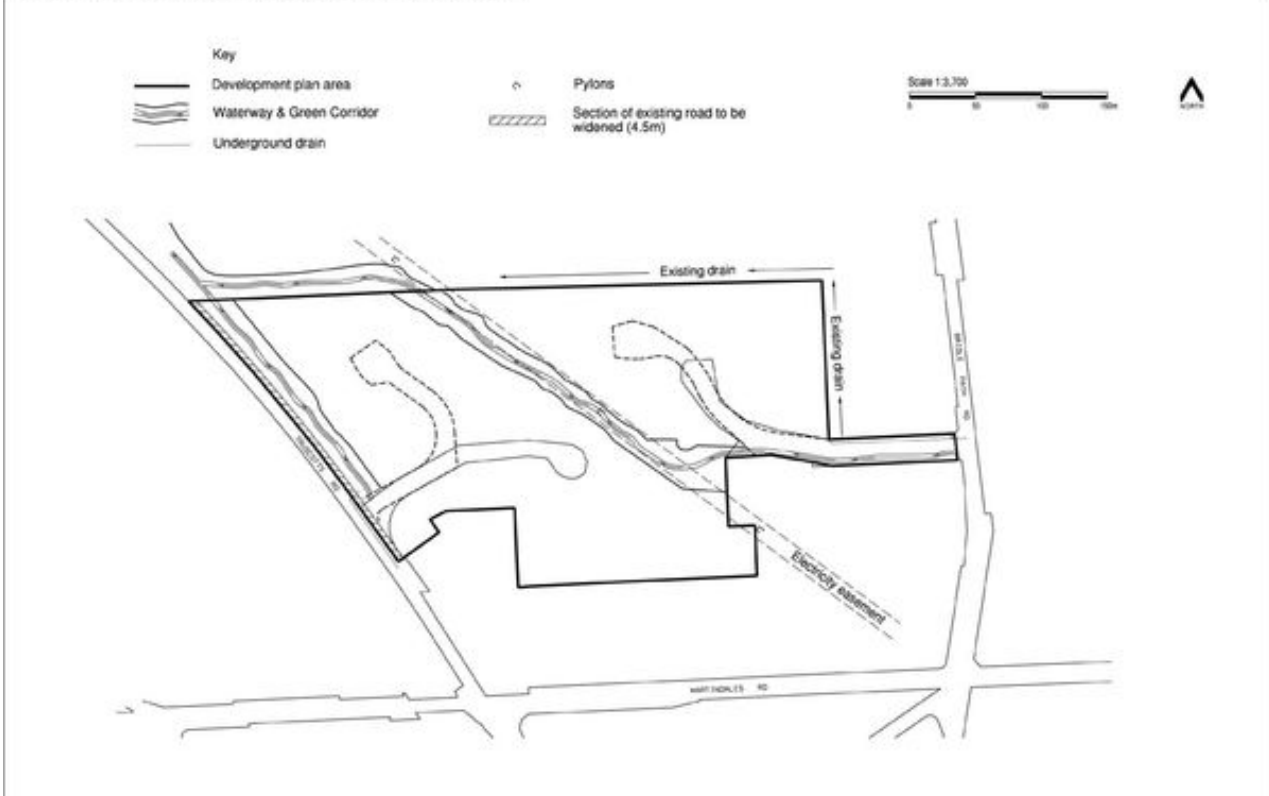

Appendix 3m - Development plan (Upper Worsleys Spur)

Updated 14 November 2005

Appendix 3m. Development Plan (Upper Worsley Spur)

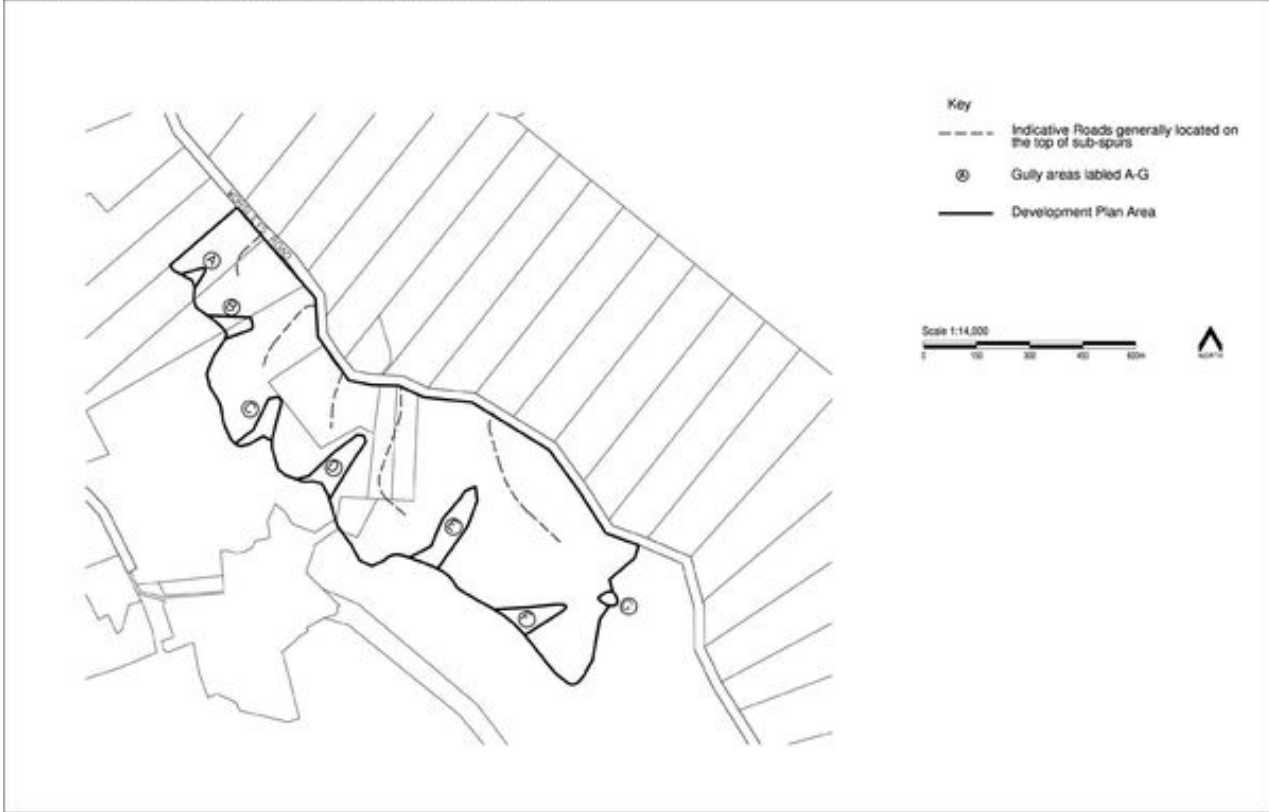

Appendix 3n - Outline development plan (Yaldhurst)

Updated 8 November 2006

Appendix 3n - Outline Development Plan (Yaldhurst)

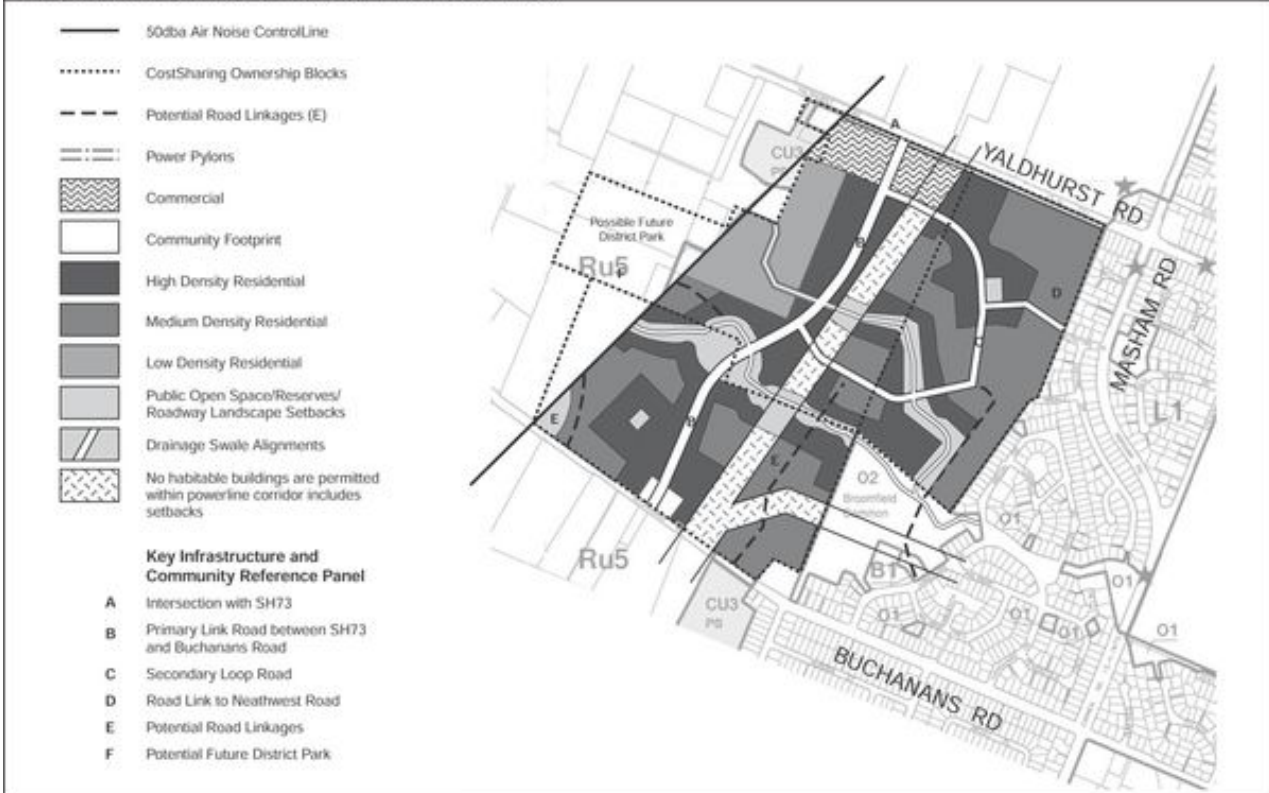

Appendix 3n.1 - Key structuring elements (Yaldhurst)

Updated 8 November 2006

Key Structuring Elements

The key structuring elements which underpin the outline development plan and which will enable a sound social, environmental and economic outcome to be achieved, including the following:

- Provision of an access point off SH73 to serve the site. This will be located at a point no less than 600m west of the existing SH73/ Masham Road intersection
- Provision of a primary movement route through the site linking SH73 to Buchanans Road
- Provision of a secondary (loop) route which helps integrate a large portion of the site located to the east of the existing transmission lines, back into the primary movement route
- Provision of tertiary link routes which help integrate the proposed development into its existing surroundings. This includes provision of an east / west link from Masham Road to the secondary route, via Neathwest Road
- Provision of a well connected, comprehensive movement network which enables public transport circulation routes and safe pedestrian and cycle movements
- Provision of mixed use 'nodes' located at the primary movement route's intersection with the SH73 in the north and Buchanans Road in the south
- Provision of a high quality public open space corridor. This is achieved through retention and enhancement of the existing overland storm water channel alignments which enables the integration of storm water attenuation areas with high quality public amenity areas
- Provision of a significant number of opportunities for higher density residential development across the site. These include alongside the open space corridor, surrounding local neighbourhood parks, within or within close proximity (400m walking distance) of the 'nodes' and adjacent to the primary movement route
- Provision of a safe setback from the existing 66kV transmission line and the efficient utilisation of these spaces

Urban Design Principles

The design principles that underpin this outline development plan are in line with the Ministry for the Environment's design guide for the urban New Zealand "People Places Spaces" - which is endorsed by the 'New Zealand Urban Design Protocol'.

Appendix 3n.1 - Key Structuring Elements

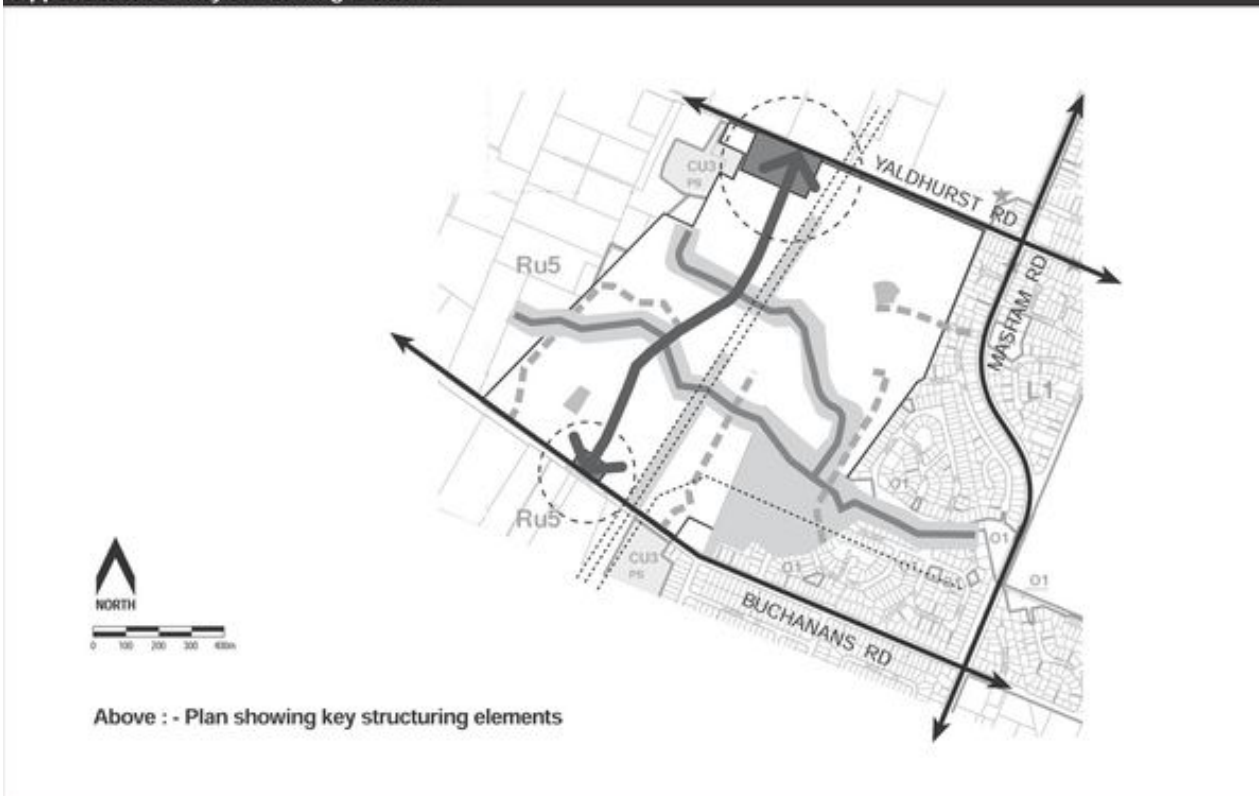

Principle	Elements	Purpose
Consolidation and dispersal	Development Patterns and Intensity	To promote higher intensity development around new nodes and lower density around the periphery. This allows local communities, business and public transport to be strengthened, and resource efficiencies to be achieved, whilst reducing environmental impacts on peripheral areas. For this site, this means creating development intensity around local nodes at the intersections of the primary spine route and SH73 and Buchanans Rd respectively. It also means focussing development intensity around high quality local neighbourhood amenity.
Integration and connectivity	Movement Networks; Building Interfaces	To promote development that is integrated and connected with its surrounding environment and other existing or future communities. This facilitates ease of access, economy of movement, and improved social interaction. For this site, this has a particular relevance to the existing adjacent residential neighbourhoods and natural open space systems that crosses through the site. Of equal relevance is the need to open up the site and connect to existing movement networks.
Diversity and adaptability	Range of Densities; Mix of Uses; Flexibility of Buildings	To promote choice through the provision of a diverse mix of compatible activities and uses. These built environments can better adapt over time. This facilitates the ability to respond efficiently to social needs, provides a range of market demands, and allows for change in lifestyles. For this site, this means that a range of local 'living' opportunities are provided, including local retail, commercial and work from home. A range of housing densities dependant on location and demographic sales (from large family to single person households) will be offered.
Legibility and identity	Town Form; Visual Character; Special Places	To promote environments that are easily understood by their users, display a strong local identity, and create appropriate visual character. This facilitates an enhanced usage, enjoyment, and pride in local place. For this site, this means that a sensitive response to the area's natural features is required so that a sense of place is engendered in equal parts of distinct built form, and natural amenity. It also means a sensitive response to development within close proximity of the existing transmission lines. Central to achieving this will be the creation of light, defined local nodes with distinct built form and uses around them.
Environmental responsiveness	Eco Systems; Green Network; Urban Water; Energy	To promote urban environments that are responsive to natural features, eco systems, water quality issues, reduced energy usage and waste production, and balance the spatial needs to achieve this with that required for urbanisation. This facilitates improved ecological outcomes. For this site, this means managing existing and future storm water run off within the site with a particular focus on storm water quality and quantity as well as the retention and enhancement of existing natural water courses (including existing water race).

Appendix 3o - Layer diagram Green Network and key principles (Yaldhurst)

Updated 8 November 2006

Green Network

This refers to the 'system' of public open space provision throughout the site. These spaces offer a wide range of amenity recreational experiences and their location and alignments are intrinsically linked to the movement network, underlying land uses and the blue network in respect of storm water management and public access.

Green Network Aims

- The provision of 'some form' of publicly accessible open space within no greater than 400m walking distance of all new development
- The retention and enhancement of existing natural ground depressions and overland flood path alignments
- Integration with the surrounding existing green network. This includes integration with Broomfield Common, the existing water race along Buchanans Rd as well as integration with a possible future District Park in the west
- The retention and enhancement of some of the site's natural history. This includes considering retention of some of the existing tree avenue alignments - especially where future user legibility can be improved and where overshadowing of private properties and open space will be limited
- Utilisation of the land/water edge potential particularly along the existing 'creek' alignments
- The provision of appropriate landscape setbacks along both Buchanans Rd and SH73. These setbacks should facilitate both pedestrian and cycle movement as well as high quality landscaping
- The provision of a series of easily accessible, safe public neighbourhood parks. Public parks are to be favoured over privately held 'common open spaces' for simpler management and greater community benefit

Key Principles

PROVISION OF A PUBLIC OPEN SPACE 'FACULTY' WITHIN 400M WALKING DISTANCE OF ALL NEW DEVELOPMENT

All new development should be located within no greater than 400m walking distance of any one of the many public open space 'types', including open space corridors and local neighbourhood parks. For High Density (A) development this maximum walking distance can be reduced to 200m.

PROVISION OF A 20M WIDE LANDSCAPING STRIP ALONG SH73

This landscaping strip (refer to Green Network diagram) should accommodate a range of functions including the following:

- East/West cycle and pedestrian movements along SH73
- 'On-site' local vehicle access (note: access off SH73 is limited to a single round about intersection)
- Screen planting in order to ensure a high quality visual interface between the development and SH73
- Ground/surface moulding, fencing and associated screen planting in order to reduce traffic noise from SH73

Appendix 3o - Layer Diagram Green Network and Key Principles

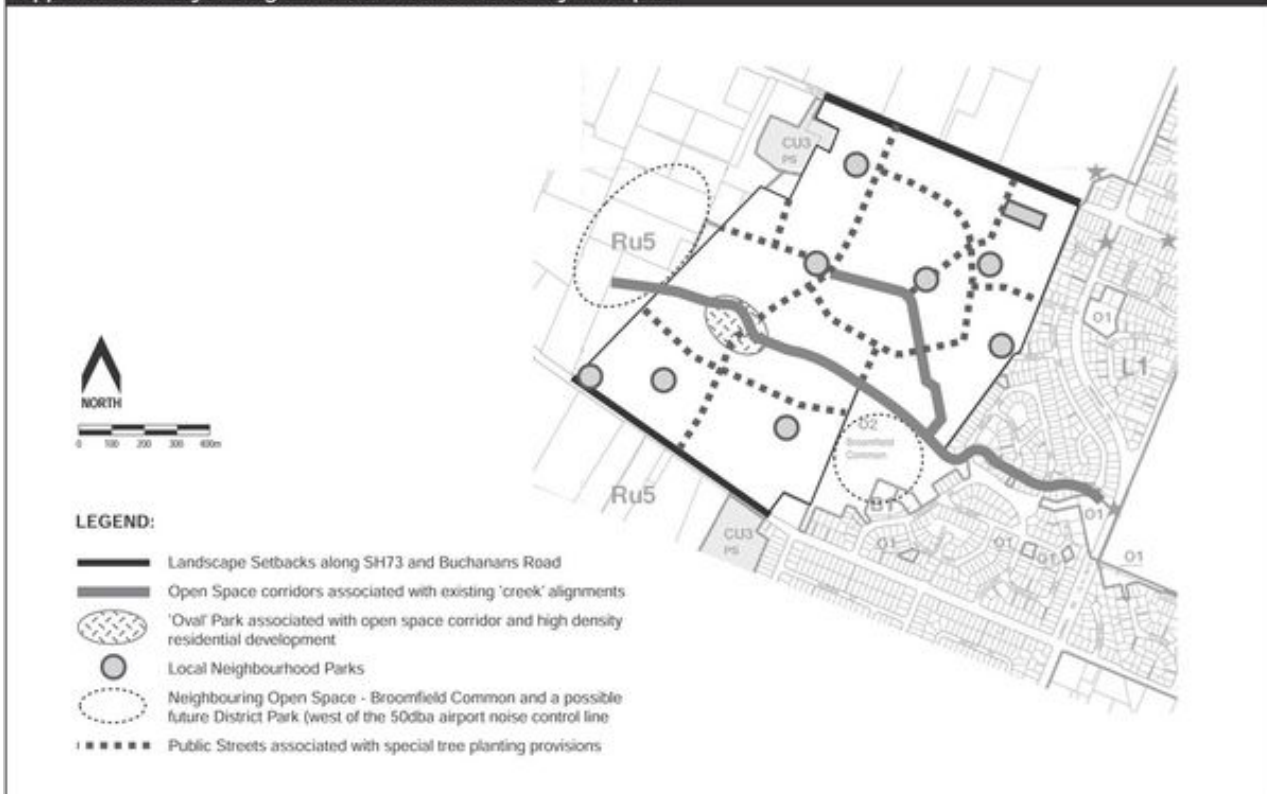

Appendix 3o - Layer diagram Green Network and key principles (Yaldhurst)

PROVISION OF A 3M WIDE LANDSCAPING STRIP ALONG THE LENGTH OF BUCHANANS ROAD

This strip (refer to Green Network diagram) is in addition to the existing Buchanans Rd reserve planting strip and is intended to ensure a high quality visual interface between the development and Buchanans Rd. It should accommodate a cycle / pedestrian path as well as trees.

PROVISION OF A CONTINUOUS PUBLIC OPEN SPACE CORRIDOR ALONG THE EXISTING 'CREEK' / SURFACE WATER CHANNEL ALIGNMENTS

The public open space corridor (excluding roads, cycleways and pedestrian footpaths) should be a minimum of 20m wide along its full length. However, this may vary up to a width of 50m in some places in

order to accommodate integrated storm water management 'facilities'. Wherever possible, public access in the form of roads, cycle ways and pedestrian footpaths should be permitted along the length of the corridor.

PROVISION OF UTILITIES WITHIN PORTIONS OF THE EXISTING 66KV TRANSMISSIONS LINE ALIGNMENTS

In order to encourage efficient utilisation of the land, storm water attenuation should be permitted within these areas. Wherever possible, public access in the form of roads, cycle ways and pedestrian footpaths should be encouraged along the edges of these strips.

PROVISION OF SOFT & HARD LANDSCAPED NEIGHBOURHOOD PARKS

These parks should be strategically located in order to provide essential local public amenity. They should be safe and easily accessible with public streets and development 'fronting' directly onto them. Wherever possible, public access in the forms of road, cycle ways and pedestrian footpaths should be encouraged along the edges of these parks

No private front yard walls or fencing greater than 1m in height, should be permitted along their boundaries. If greater than 1m in height they should ensure high levels of 'through visibility' (i.e. palisade type fencing). These parks should not have a dimension of less than 20m and at least 50% of these parks should contain child playground or other recreational facilities (i.e tennis courts). Storm water attenuation should also be permitted within these areas.

PROVISION OF A PUBLIC OPEN SPACE 'OVAL'

This should be located at the intersection of the open space / 'creek' corridor alignment and the proposed primary movement route. It should not be narrower than 100m in width (excluding roads but including possible on-street car parking and footpaths). Continuous public access in the form of roads, footpaths or cycle ways should be formed along the entire perimeter of this space. No private front yard walls or fencing greater than 1m in height, should be permitted adjacent to this space. Recreational facilities (i.e tennis courts) and storm water attenuation facilities should also be permitted within these areas. Road alignments through the open space oval should be avoided.

Appendix 3p - Layer diagram Blue Network and key principles (Yaldhurst)

Updated 8 November 2006

Blue Network

This refers to the 'above ground' system designed in order to help meet the site's future anticipated storm water quality and quantity requirements. These include swales and flow paths as well as detention / soakage facilities within existing creek lines, transmission alignments and neighbourhood parks.

Blue Network Aims

- To incorporate a 'shared' approach whereby storm water management / attenuation areas also double up as green network spaces
- To ensure sensitive storm water quality and quantity requirements are achieved
- To integrate best practice technique into a site-wide 'total storm detention' approach
- To ensure the design and operation of the stormwater management system so as to reduce the potential for bird strike issues associated with the operation of Christchurch International Airport
- In addition, in any application for discharge consent from Environment Canterbury, to ensure that the design and operation of the stormwater management system includes provision for the treatment of stormwater from roads and sealed carparking areas, and for monitoring of that treated stormwater

Key Principles

UTILISATION OF INTEGRATED APPROACH FOR STORM WATER ATTENUATION

Use of an integrated solution which combines both engineered techniques and low impact storm water attenuation techniques is considered an appropriate approach for total storm detention across the site. The integrated solution reflects a connected surface water conveyance drainage network as shown on the Blue Network Layer Diagram.

PROVISION FOR STORM WATER ATTENUATION WITHIN THE EXISTING CREEK CORRIDORS

Existing creek alignments should be retained and in some places widened, in order to help facilitate total storm water detention across the site. The conveyance drainage network will feed to and utilize these alignments as shown as the Blue Network Layer Diagram

PROVISION OF 'LOCAL' STORM WATER DETENTION / SOAKAGE FACILITIES

The local storm water detention and soakage facilities will be in general accordance with the Living G (Yaldhurst) Surface Water Management System Operation and Maintenance Management Plan. This Management Plan is a 'Living' document held by the Christchurch City Council that will evolve with the development of the site. Issues such as operations requirements, treatment maintenance, monitoring (including of stormwater), planting for amenity, and planting to dissuade bird species that are a risk to safe operation of the Christchurch International Airport and to ensure groundwater will not be degraded will be incorporated in the management plan as development progresses.

MITIGATION OF BIRD STRIKE HAZARD TO AIRCRAFT

Design of a storm water management system that recognises the concerns of Christchurch International Airport with respect to bird strike hazard and the management of bird habitats that constitute a hazard to aircraft.

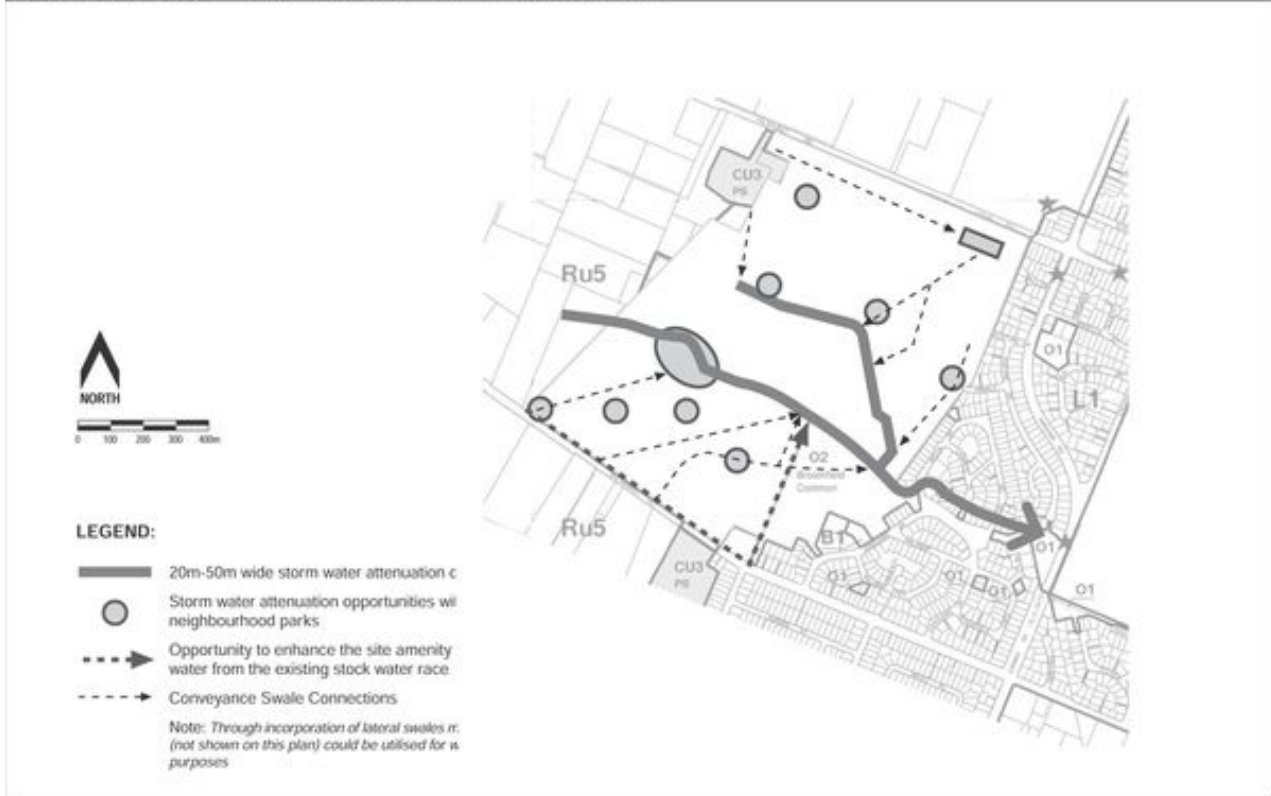

Appendix 3q - Layer diagram Movement Network (Yaldhurst)

Updated 8 November 2006

Movement Network

This refers to the system of roads, cycle ways, pathways and linkages throughout the site. This system also has a relationship with the 'green' and 'blue' networks in respect of pedestrian and cycleway linkages.

Movement network aims

- The provision for vehicular, bus, cycle and pedestrian movement 'to and through' the site. This is best achieved through formation of legible, well connected network, primarily of streets that combine as many of these mode as possible
- The provision of an efficient network that helps disperse traffic and minimises the impact of new development on surrounding areas.
- The provision of a network that integrates the site into the surrounding environments and helps 'open up' the site in order to maximise opportunities.
- The provision for vehicular, pedestrian and cycle movements along most edges of the green network.

Specific areas to be addressed include:

SAFETY

Sound traffic engineering design should be applied in order to minimise traffic accidents. This should preferably be done in conjunction with strategies that reduce traffic speeds thereby still allowing for good integration between pedestrians, cyclists and cars.

The network should be designed to encourage local traffic (at the right speeds) throughout the area and to enable 'natural' surveillance from motorist so as to assist with personal safety.

EFFICIENCY

The movement network should be well connected so as to provide a choice of routes for all users as well as enable reduced travel distances.

WALKABILITY

Urban development blocks (the area of land enclosed by public space or streets), should be kept relatively small to facilitate and encourage walking.

LEGIBILITY

To ensure the layout is easily understood by users, routes should be relatively direct. Vistas and key junctions should be marked by landmark elements such as neighbourhood parks, key buildings or special landscape features.

Road Network Plan

Appendix 3q - Layer Diagram Movement Network - Road Network Plan

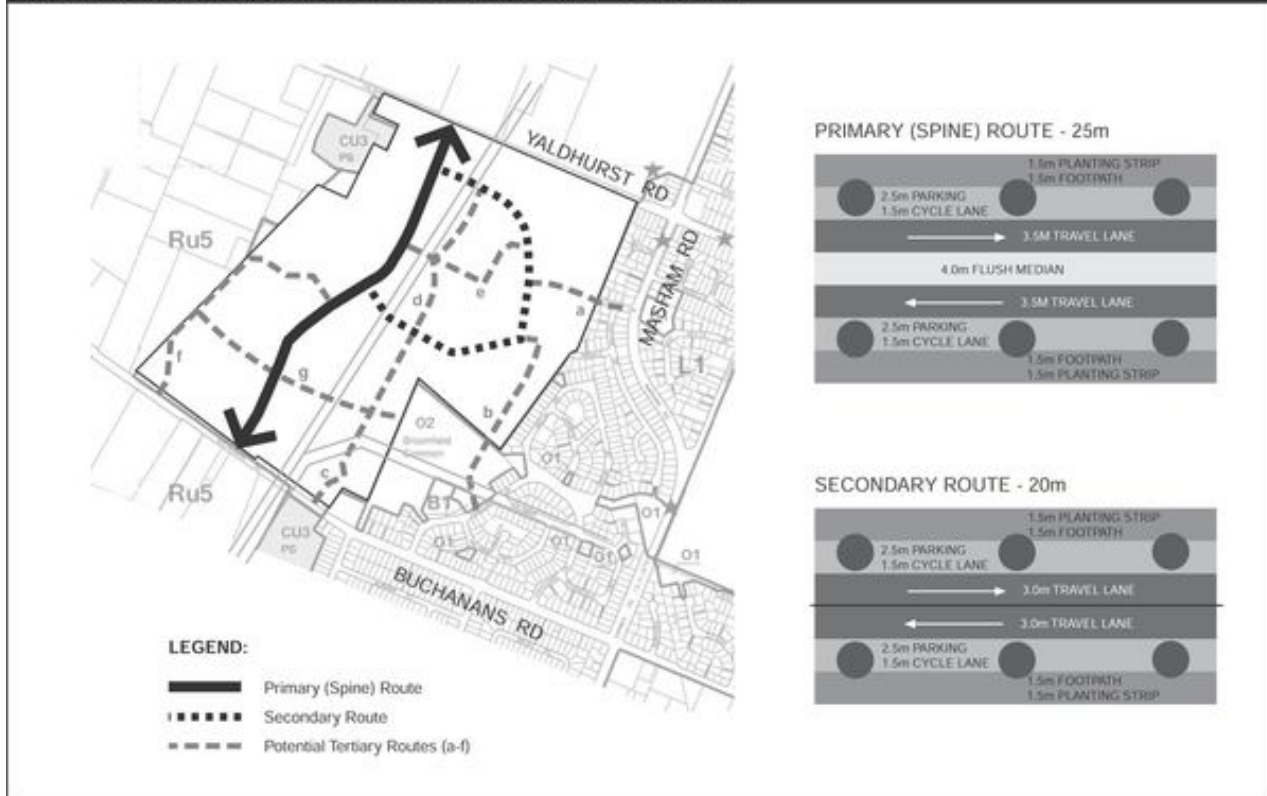

Road Network

This refers to the hierarchy of proposed road across the site.

The proposed network has been designed in order to integrate with the green and blue networks as these also provide essential pedestrian and cycle way linkages. The distribution of land uses across the site is intrinsically tied to this network. An example of this is the location of non-residential uses at the 'nodes', this is in order to enable these uses to benefit from the 'movement economy'.

Key Principles

PROVISION OF A PRIMARY NORTH / SOUTH (SPINE) ROUTE

This route (refer to Road Network Plan) should provide access off SH73 via a round-about (located at no less than 600m from the Masham Rd / Yaldhurst SH73 intersection) and run south through the site (west of the existing transmission lines) to intersect with Buchanans Rd at a point west of existing transmission lines. This routes (refer to the indicative layout in the Primary (Spine) Route diagram) should act as a local collector road and should be designed so as to accommodate vehicular, bus, cycle and pedestrian movements, as well as access to adjacent properties.

PROVISION OF A SECONDARY (LOOP) ROUTE

This route (refer to Secondary Route diagram) should link directly into the northern 'node' and connect with the primary route at a point approximately 200m from the proposed new roundabout on SH73. This route should reconnect with the primary route at a point approximately 500 - 600m from the roundabout located on SH73. This route will help integrate the portion of the land located to the east of the existing transmission lines into the overall development and should also help reduce the impact of traffic on the existing adjacent residential neighbourhoods. The route should be designed so as to accommodate vehicular, bus, cycle and pedestrian movements as well as easy access to adjacent residential properties (refer to the indicative layout in the secondary route diagram)

PROVISION TERTIARY ROUTES

These routes (refer to Road Network Plan) should at least provide the following:

- (a) an indirect east/west connection from the proposed secondary route to existing Neathwest Rd
- (b) the road network layer diagram and Outline Development Plan shows a possible connection south from the proposed secondary route, through Broomfield Common, linking onto Vanguard Drive. The Christchurch City Council cannot endorse the construction of a road through Broomfield Common because:
 - (i) It creates a busy transport thoroughfare through the park;
 - (ii) It dislocates the open park by Vanguard Drive; and
 - (iii) Broomfield Common is held under the Reserves Act and a revocation process must be followed before a road can be achieved. Any revocation will need to be justified by benefits to Broomfield Common such as additional land and all alternatives considered such as Arcon Reserve or direct purchase of a property in Arcon Place.
- (c) an indirect north/south connection, linking Buchanans Rd to the proposed northern arms of the secondary route,
- (d) an extension of tertiary route,
- (e) an east/west route linking the secondary route (through an intersection with route (d), with the primary route,
- (f) a north/south route running from Buchanans Rd along portion of the western boundary, along one edge of the proposed 'oval' park and linking into the primary route, and
- (g) and east/west route connecting across from Broomfield Common to tertiary route 'f' on the western boundary.

All 'Other' Streets

All 'other' streets not shown on the Road Network Plan are subject to future detailed site development planning and design. In general all these 'lower order' streets should be designed as 'shared/liveable space' and as such should be attractive and pedestrian / cycle friendly. Key characteristics should include the following:

SLOWER VEHICLE STREET

Street layout and design should encourage lower vehicle speeds. This can be achieved in a number of ways such as:

- Narrower streets, with 5.8m kerb to kerb (excluding parking bays) widths should be acceptable in lower order residential streets

- Tighter kerb radii, and general on street vehicular access to properties will also assist.

ON-STREET PARKING

On street parking should be provided where practical. Consideration should be given to the variation in materials, in order to provide visual interest.

OFF-STREET PARKING

The impact of off-street parking on pedestrian and visual amenity should be mitigated. This can be done in a number of ways:

- By limiting the width of the driveway access at the kerb position to no greater than 3m
- By incorporating a range of surface materials / colours and textures
- Through the use of back lanes
- By setting the garage back from the face of the dwelling by at least 1m

STREET CHARACTER

Street should have a high quality visual character. This can be achieved by:

- Fronting of the green network a public street
- Consistent use of street trees
- Narrower carriageway widths
- Attractive street lighting and other street furniture elements
- The variation of materials such as the use of paving cobbles in parking bays

Public Transport Network

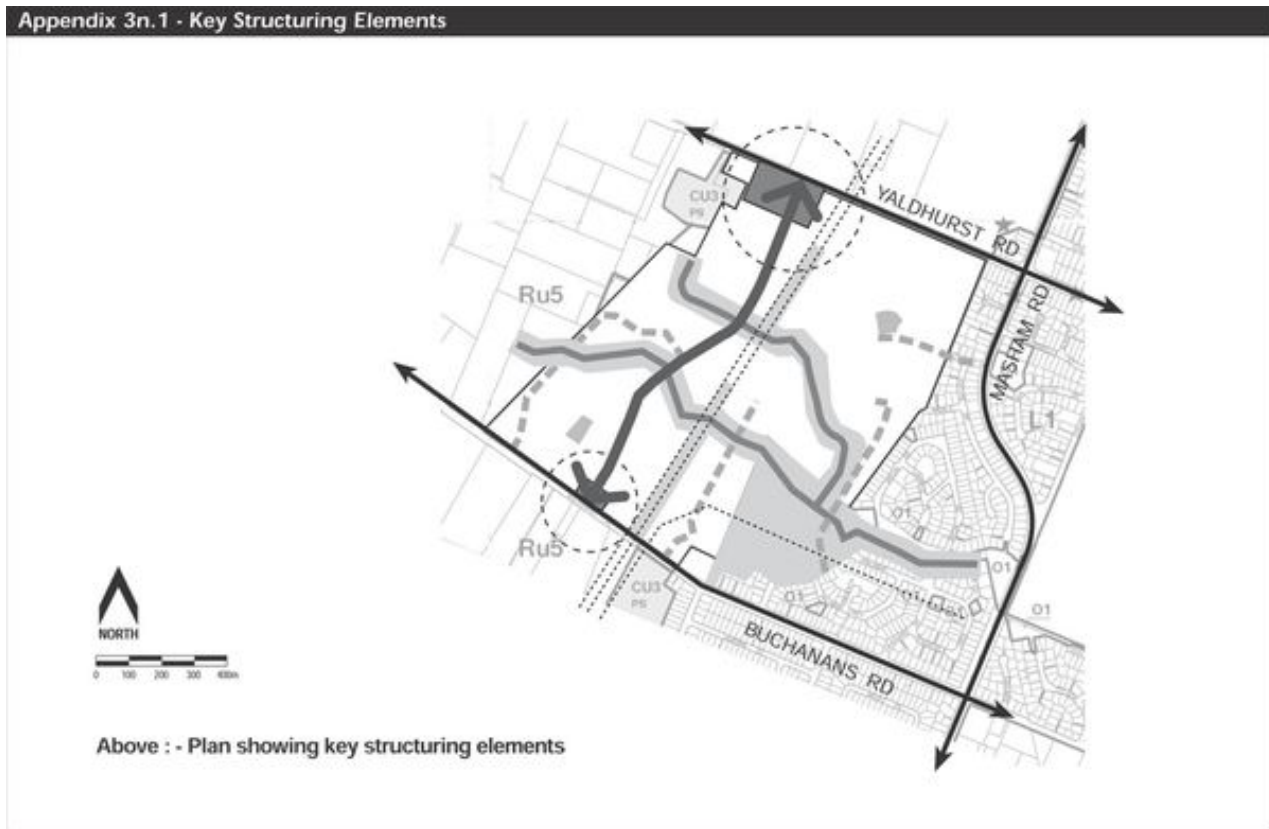

Public Transport Network

This refers to the possible bus route options provided across the site. The proposed network options are aimed to encourage the use of public transport and maximising possible user patronage. This has the ability to help reduce reliance on private vehicle ownership.

Two possible route options (refer to Public Transport Network diagram) are provided. Option A offers a direct route from SH73 to Buchanans Road along the primary 'spine' route. Route option B still ensures movement from SH73 to Buchanans Rd, however this is via an additional route along the secondary loop road. Both routes are intrinsically linked to the proposed land uses and underlying movement network.

Key Principles

PROVISION FOR BUSES WITHIN THE PRIMARY AND SECONDARY MOVEMENT ROUTES

Good traffic design should be applied in order to ensure efficient bus movements, safe travel speeds and minimal impact on traffic, pedestrian and cyclist flows.

PROVISION OF BUS STOPS AT BOTH 'NODES'

The nodes have the ability to contain essential facilities such as local services, retail/commercial opportunities as well as the highest concentrations of residential development. By locating bus stop in these locations we are also assured of good walkable catchments and as such area able to maximise possible patronage.

Cycle Network Plan

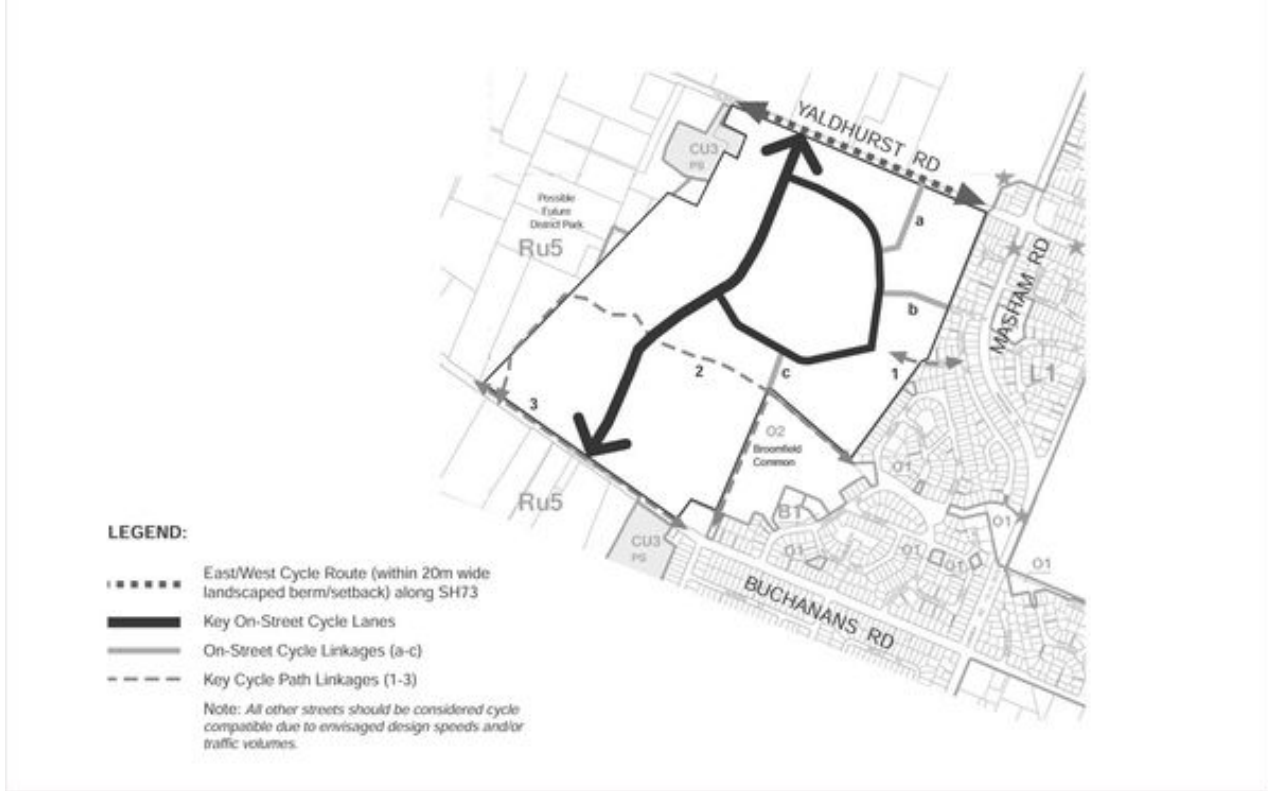

Cycle Network Plan

This refers to the system of cycle ways, cycle paths and linkages 'to and through' the site. This network has a relationship with the underlying movement network and as such is integrated with both the green and blue networks.

Four key 'types' of cycle movement (refer to the Cycle Network diagram) area proposed, however in general, all 'other' streets within the development should be considered as cycle compatible due to envisaged design speeds and low traffic volumes.

Key Principles

PROVISION FOR CYCLISTS WITHIN THE PRIMARY AND SECONDARY MOVEMENT ROUTES

Good traffic design should be applied in order to ensure efficient and safe cyclists movement along both these routes.

PROVISION OF A CYCLE PATH WITHIN THE SH73 LANDSCAPE SETBACK

In order to facilitate broader city wide cycle initiatives, a cycle path should be accommodated within the 20m wide SH73 landscape setback. This will facilitate east/west cycle movement along State Highway 73. It will also provide additional opportunities for cycle access to and from the site.

PROVISION OF KEY ON-STREET CYCLES LINKAGES

These routes (refer to the Cycle Network Diagram) should at least provide the following:

- (a) a north/south connection from the cycle path within the SH73 landscape setback to the proposed secondary movement route.
- (b) an east/west connection from Neathwwest Rd to the proposed secondary movement route, and
- (c) a north/south connection, linking the proposed secondary route to Broomfield Common.

PROVISION OF KEY CYCLE PATH LINKAGES

These routes (refer to the Cycle Network Diagram) should at least provide the following:

- (1) and east/west connection (through a local reserve)m from the proposed secondary movement route to Amdale Ave, and
- (2) and east/west connection (along the proposed open space network), linking Broomfield Common to a possible future District Park, located west of the site within the 50dBA Ldn noise contour line and,
- (3) and east/west connection along Buchanans Road.

Pedestrian Network Concept

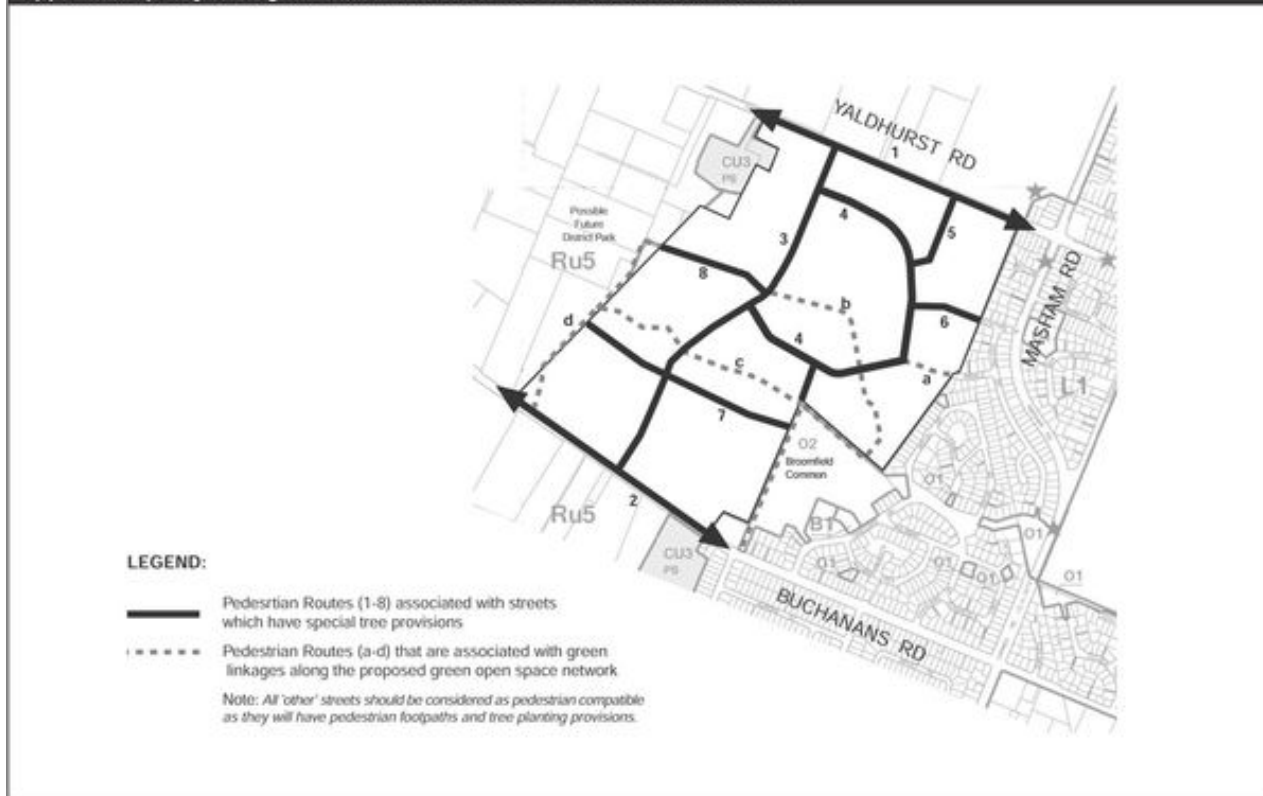

Pedestrian Network

This refers to the system of pedestrian footpaths and linkages 'to and through' the site. This network has a relationship with the underlying movement network and land uses and as such is also integrated with the green and blue networks.

Two overarching 'types' of pedestrian movement (refer to Pedestrian Network diagram) area proposed within the development, however in general, all 'other' streets within the development should be considered as pedestrian compatible due to envisaged footpath and street tree provisions.

Key Principle

PROVISION OF FOOTPATHS AND SPECIAL TREE PLANTING WITHIN KEY MOVEMENT ROUTES & LINKAGES

These routes/linkages should at least provide the following:

- (1) an east/west linkage contained within the 20m landscaping setback along SH73,
- (2) an east/west linkage within a 3m wide landscaping setback proposed along Buchanans Rd,
- (3) a north/south linkage, along the primary movement route linking SH73 with Buchanans Rd,
- (4) a loop connection along the proposed secondary movement route and connecting back into the primary movement route,
- (5) a north/south connection from SH73 to the proposed secondary movement route,
- (6) an east/west connection from the proposed secondary movement route to Neathwest Rd,
- (7) an east/west connection from Broomfield Common to the possible future District Park (located west of the 50dBA Ldn noise contour line, and
- (8) an east/west connection from the possible future District Park and intersecting with the primary movement route adjacent to the northern arm of the green open space network.

PROVISION OF KEY FOOTPATH CONNECTIONS WITHIN THE GREEN NETWORK

These should at least provide the following:

- (a) an east/west linkage connection between Amdale Ave, and the proposed secondary movement route,
- (b) an east/west linkage within the northern arm of the green/blue network, linking Broomfield Common with the primary movement network,
- (c) an east/west connection linking Broomfield Common in the east to a possible future District Park in the west, - via the southern arm of the green/blue network, and
- (d) a north/south connection with the possible future District Park, linking Buchanans Rd with key movement route 8.

Appendix 3r - Development Plan (West Wigram)

Appendix 3r - Development plan - West Wigram

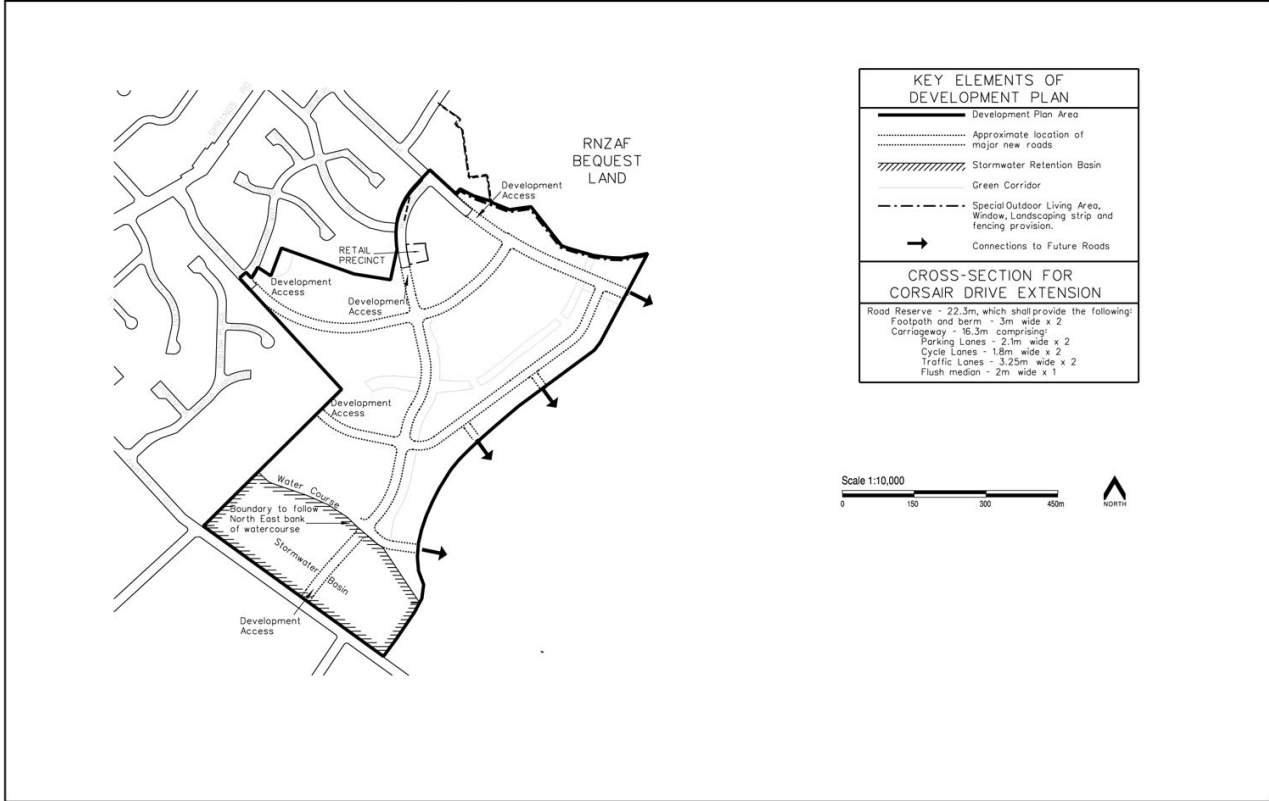

Appendix 3s - Outline Development Plan for East Belfast

Updated 12 March 2012

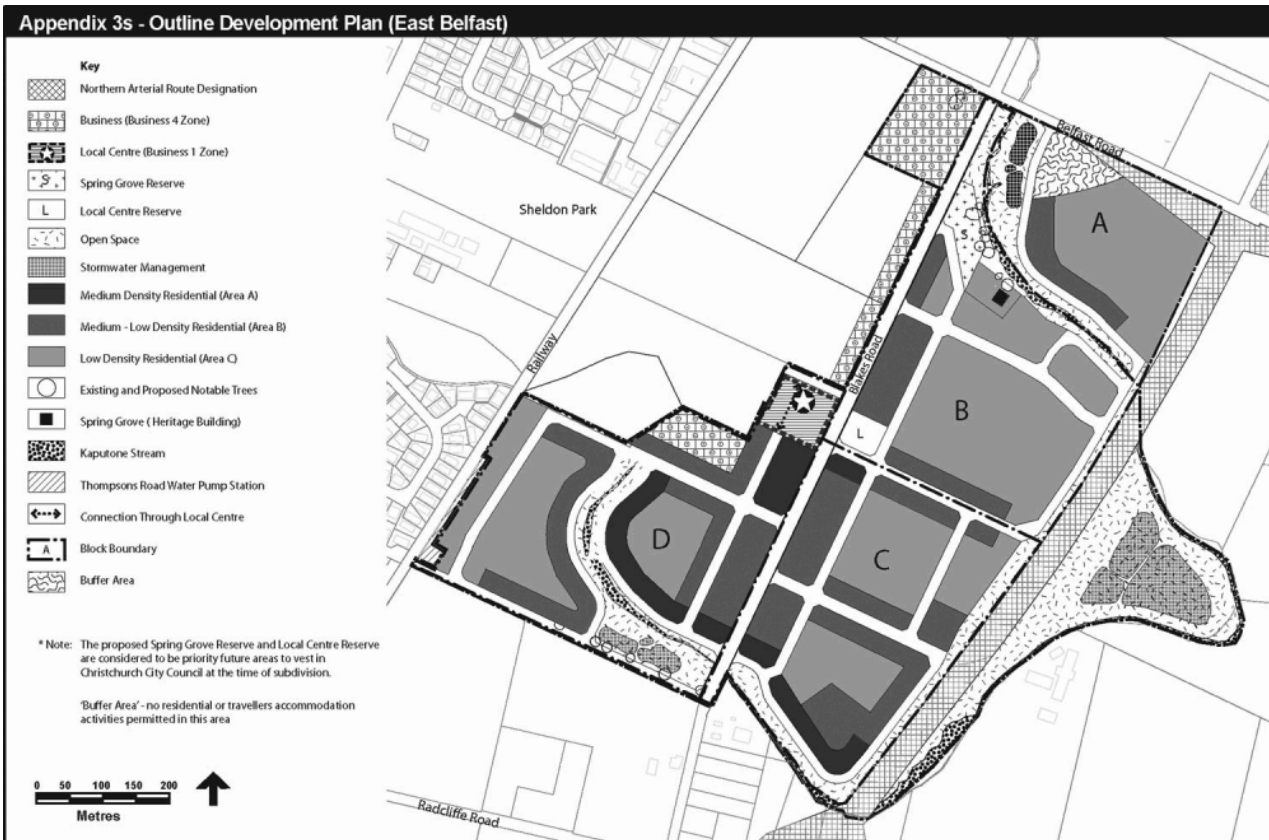

Appendix 3s/1 - Green Network Layer Diagram for East Belfast

Updated 12 March 2012

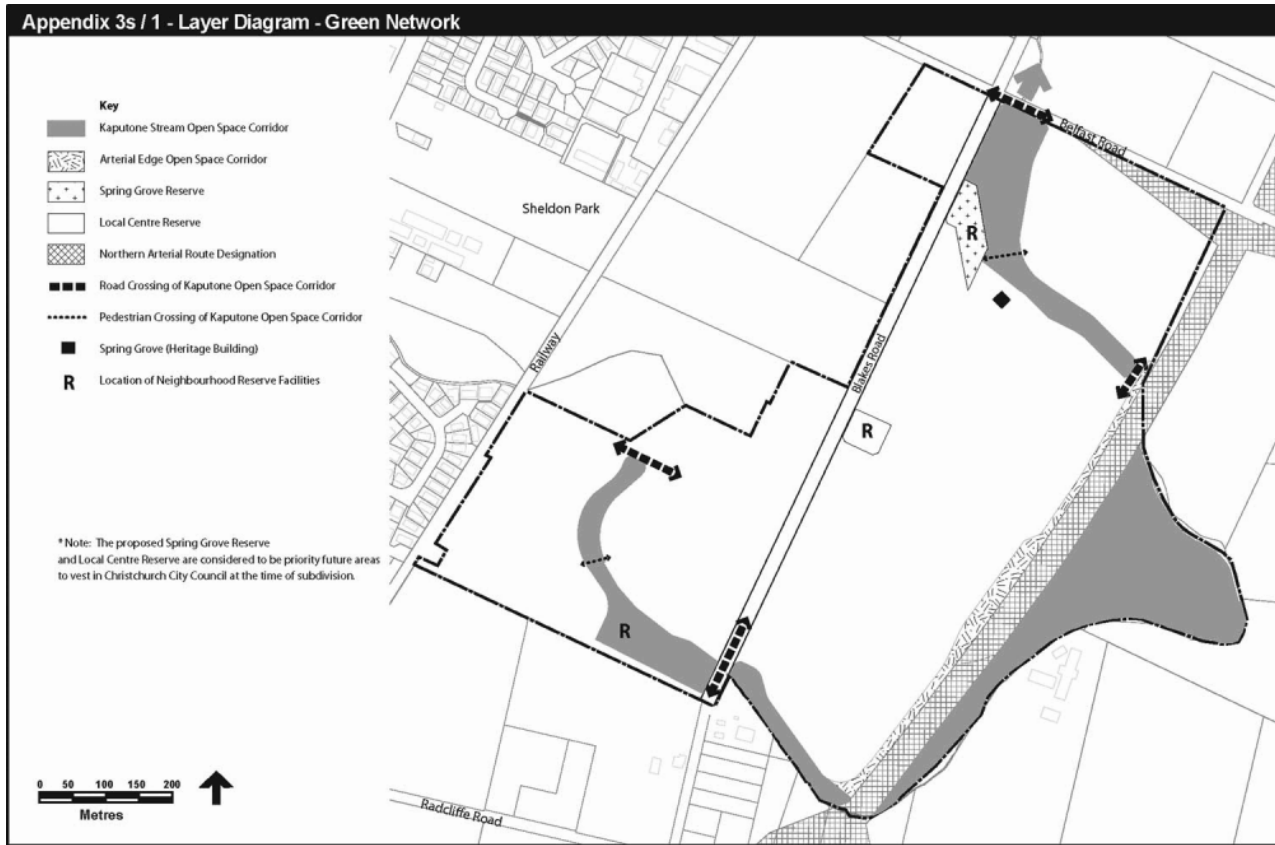

Appendix 3s/2 - Blue Network Layer Diagram for East Belfast

Updated 12 March 2012

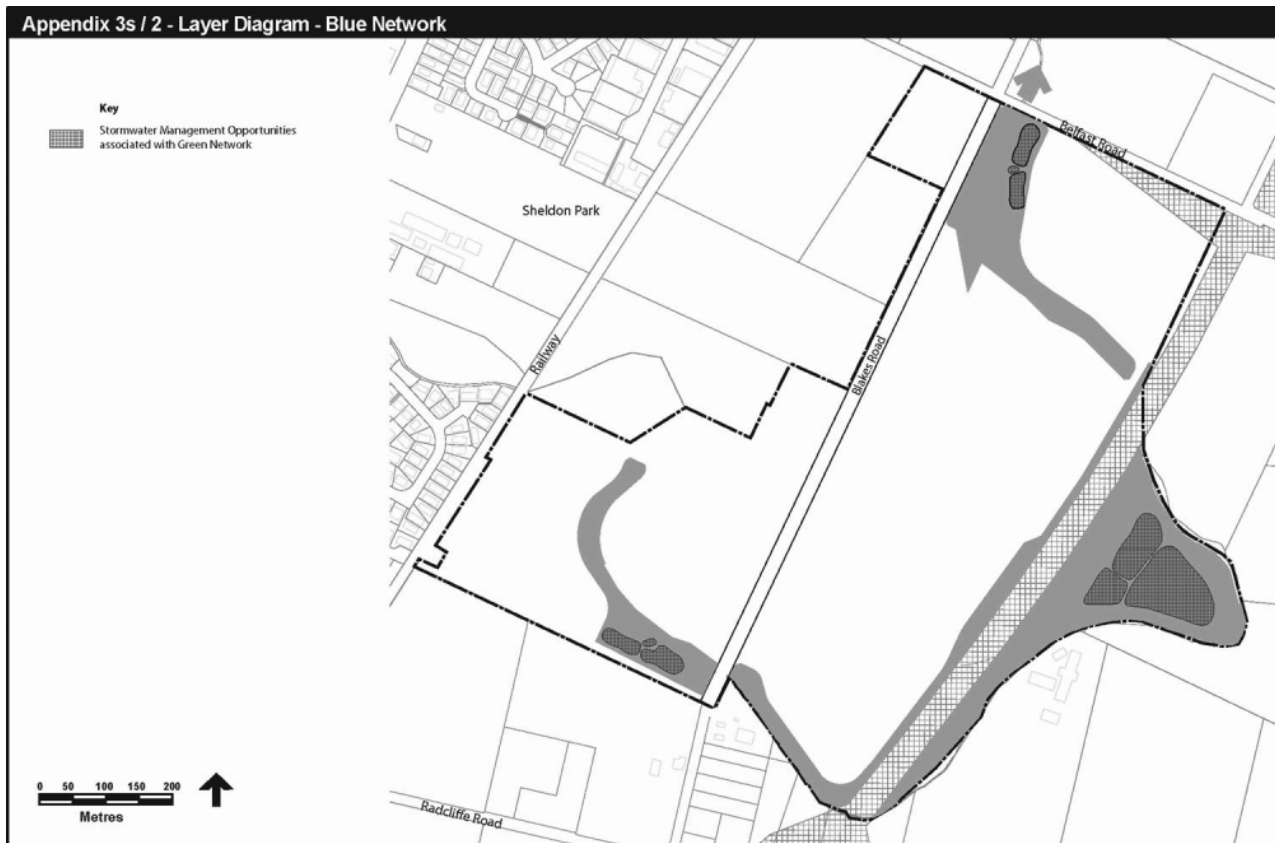

Appendix 3s/3a-3d - Movement Network for East Belfast

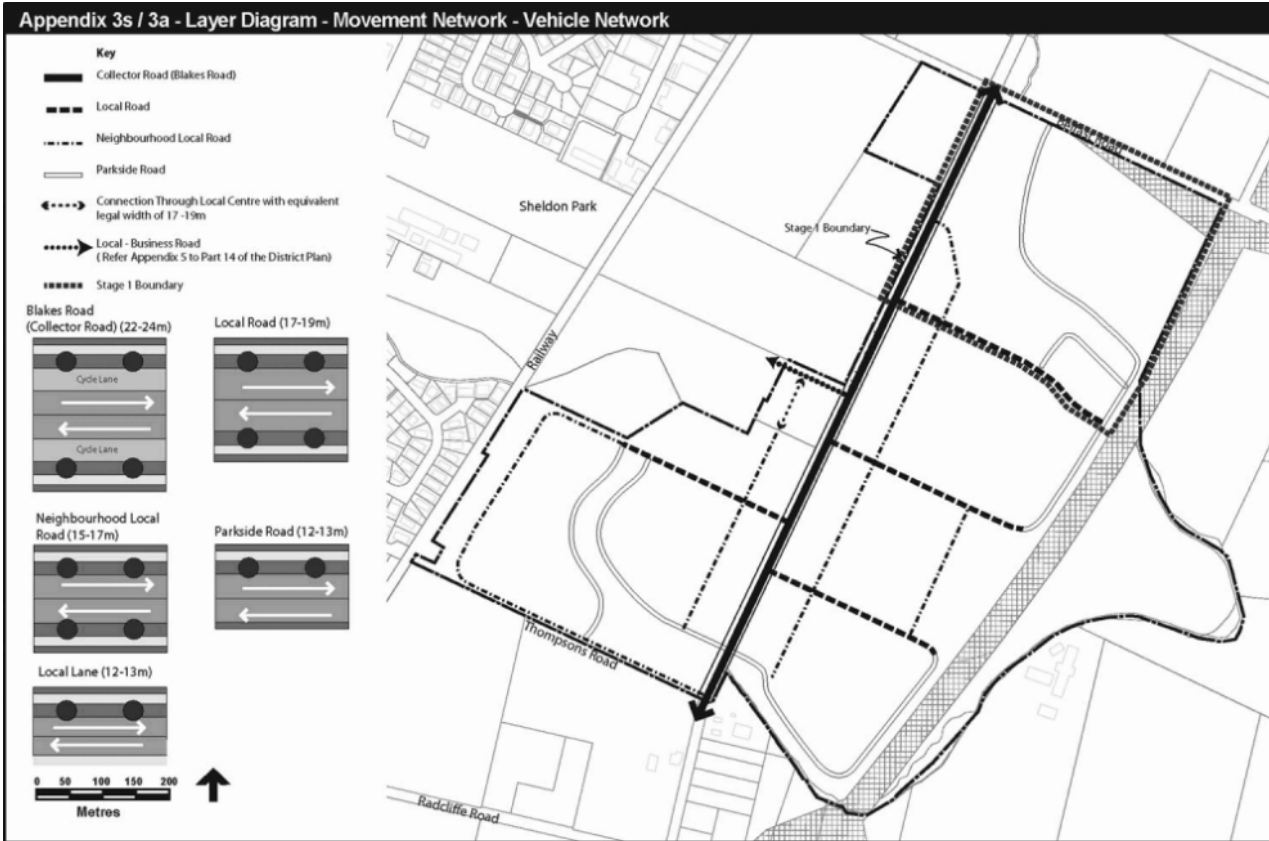

Appendix 3s / 3c - Layer Diagram - Movement Network - Cycle Network

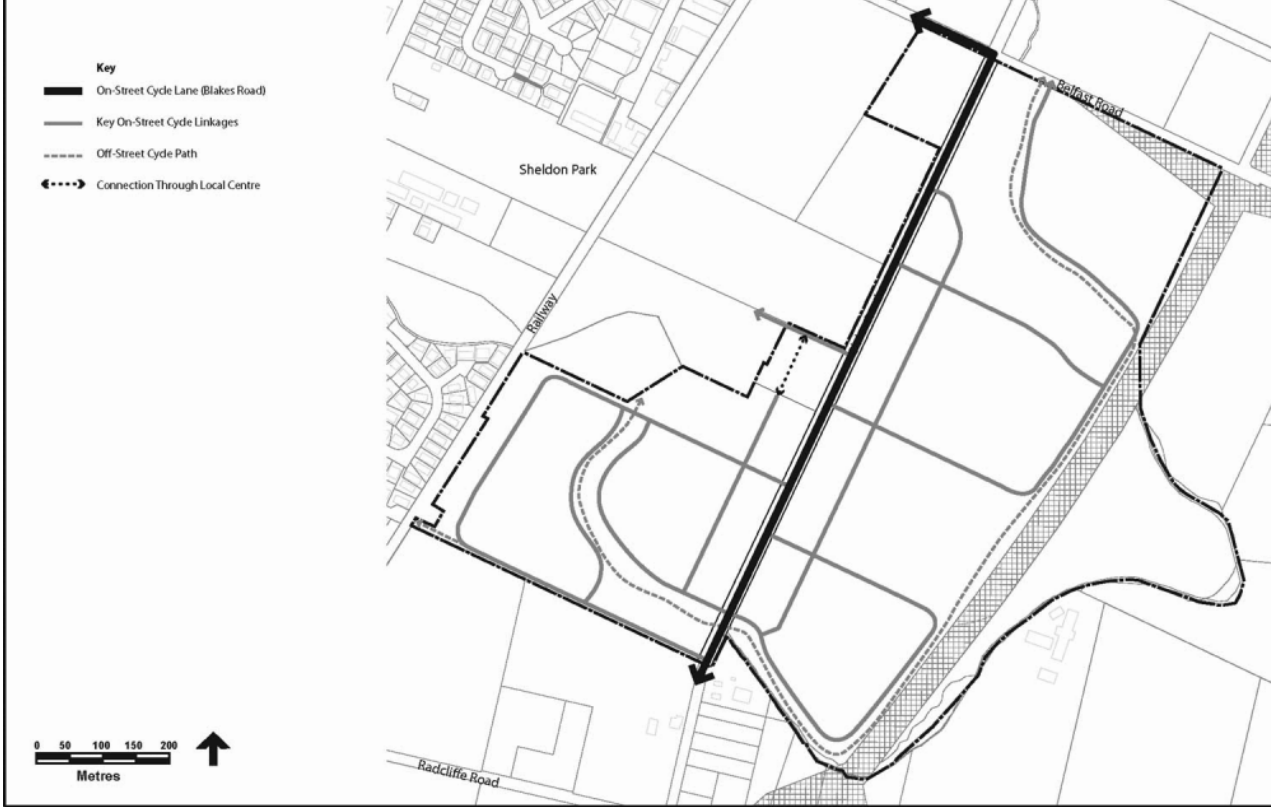

Appendix 3s / 3d - Layer Diagram - Movement Network - Pedestrian Network

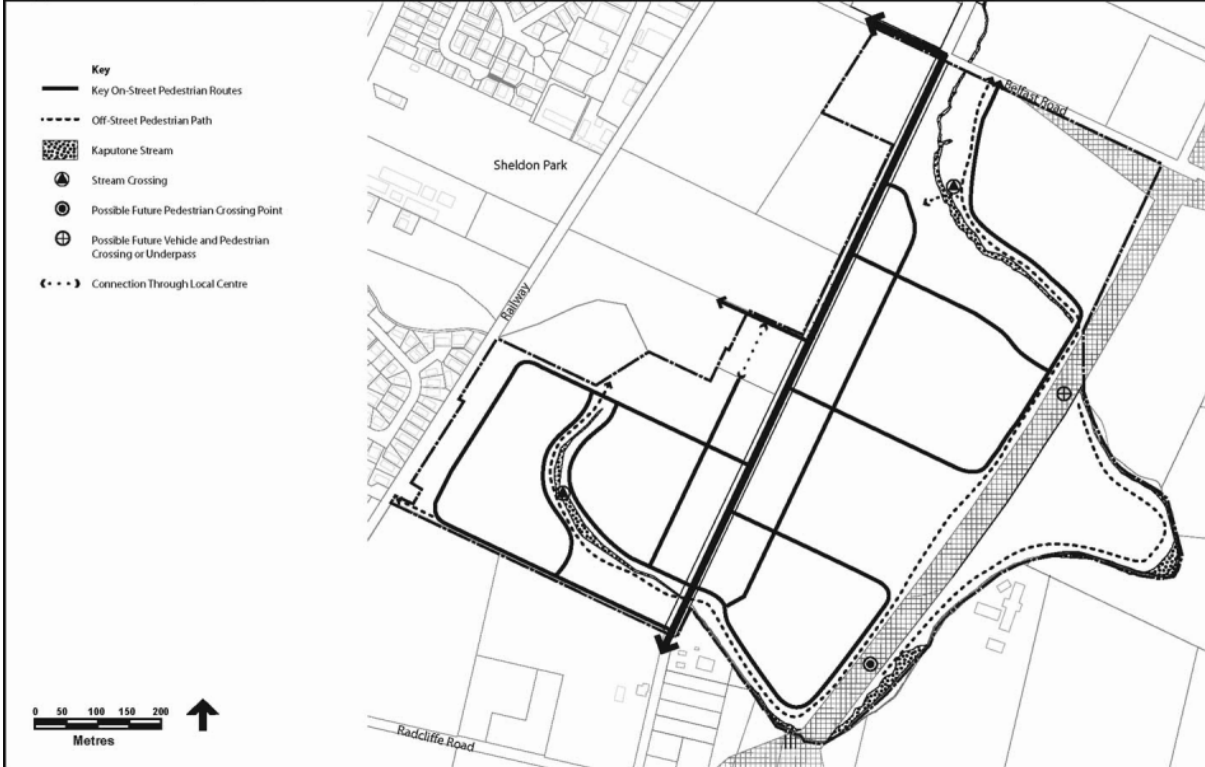

Appendix 3T - Outline Development Plan (Awatea)

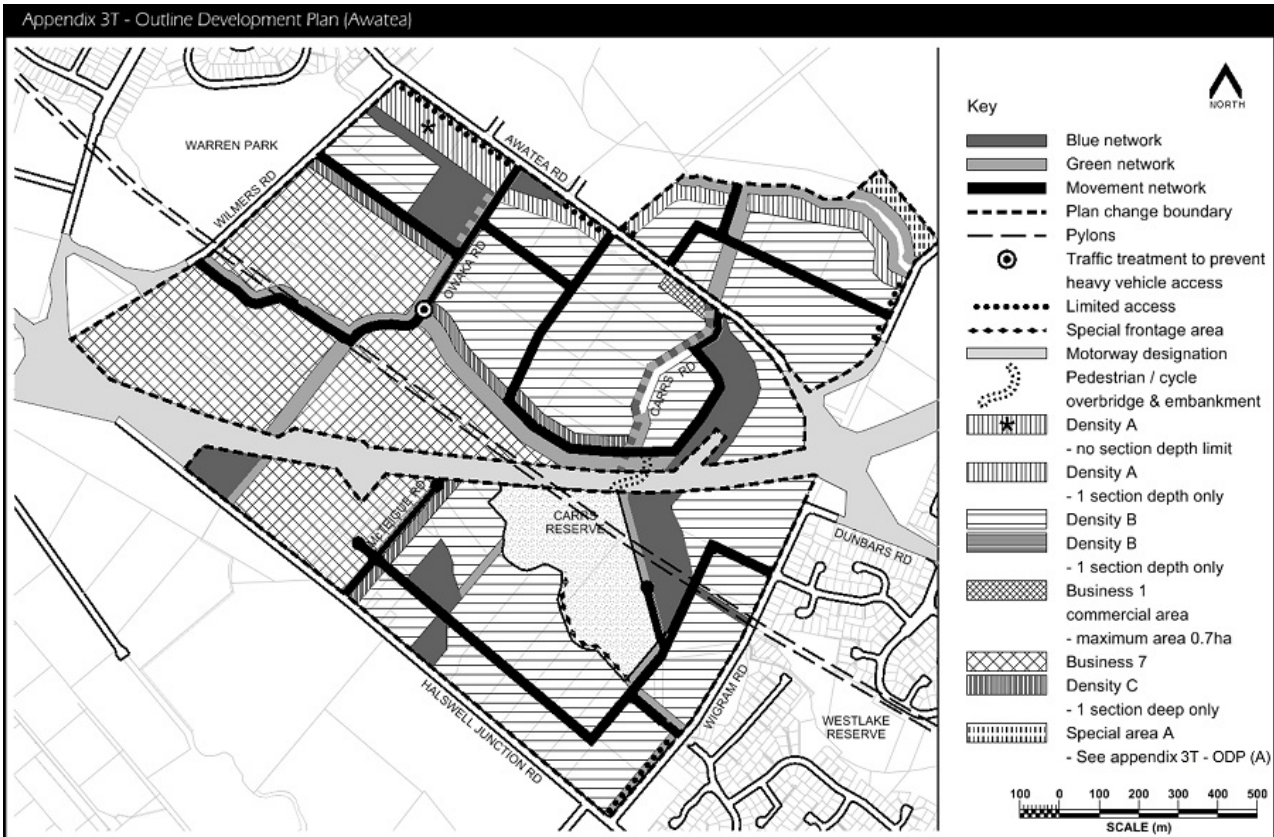

Appendix 3T - Outline Development Plan (A) (Awatea)

Updated 11 July 2011

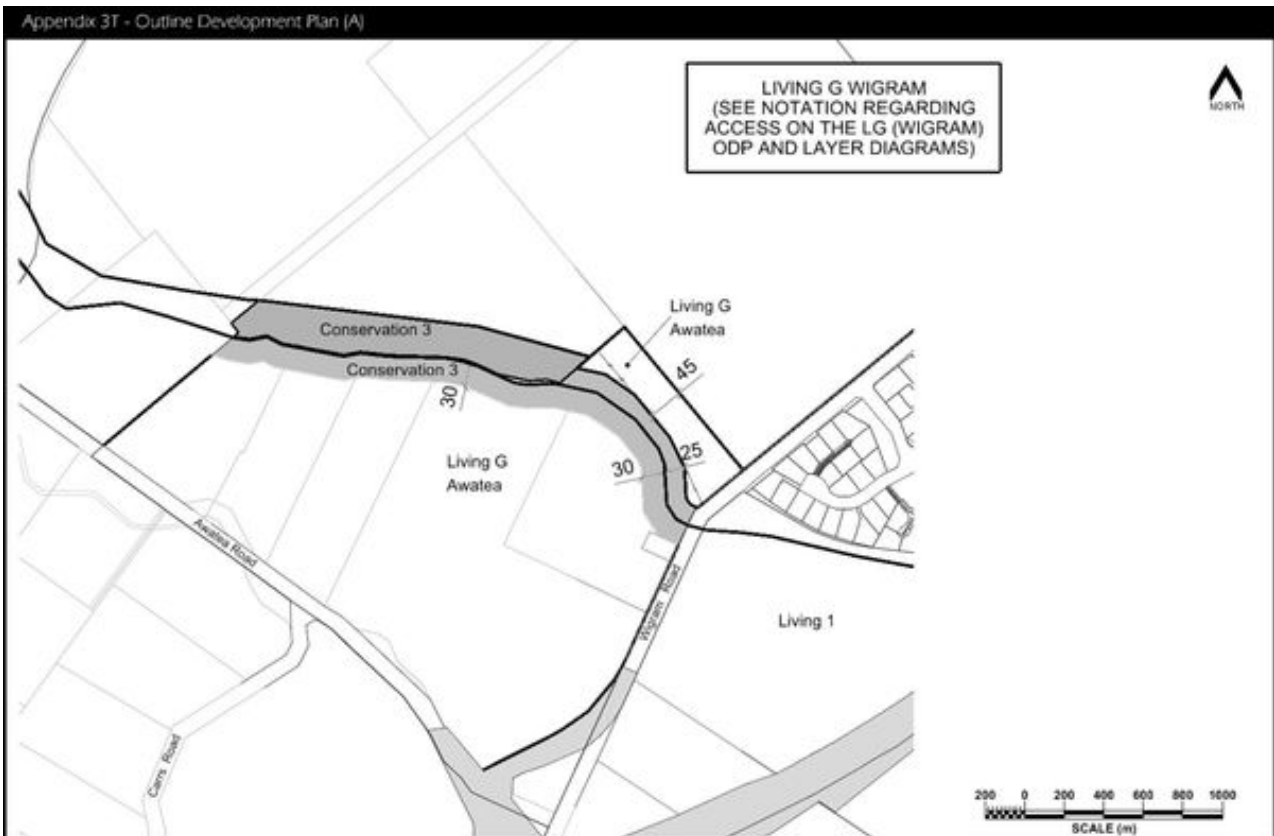

Appendix 3T(a) - Fixed Structural Elements Diagram (Awatea)

Updated 11 July 2011

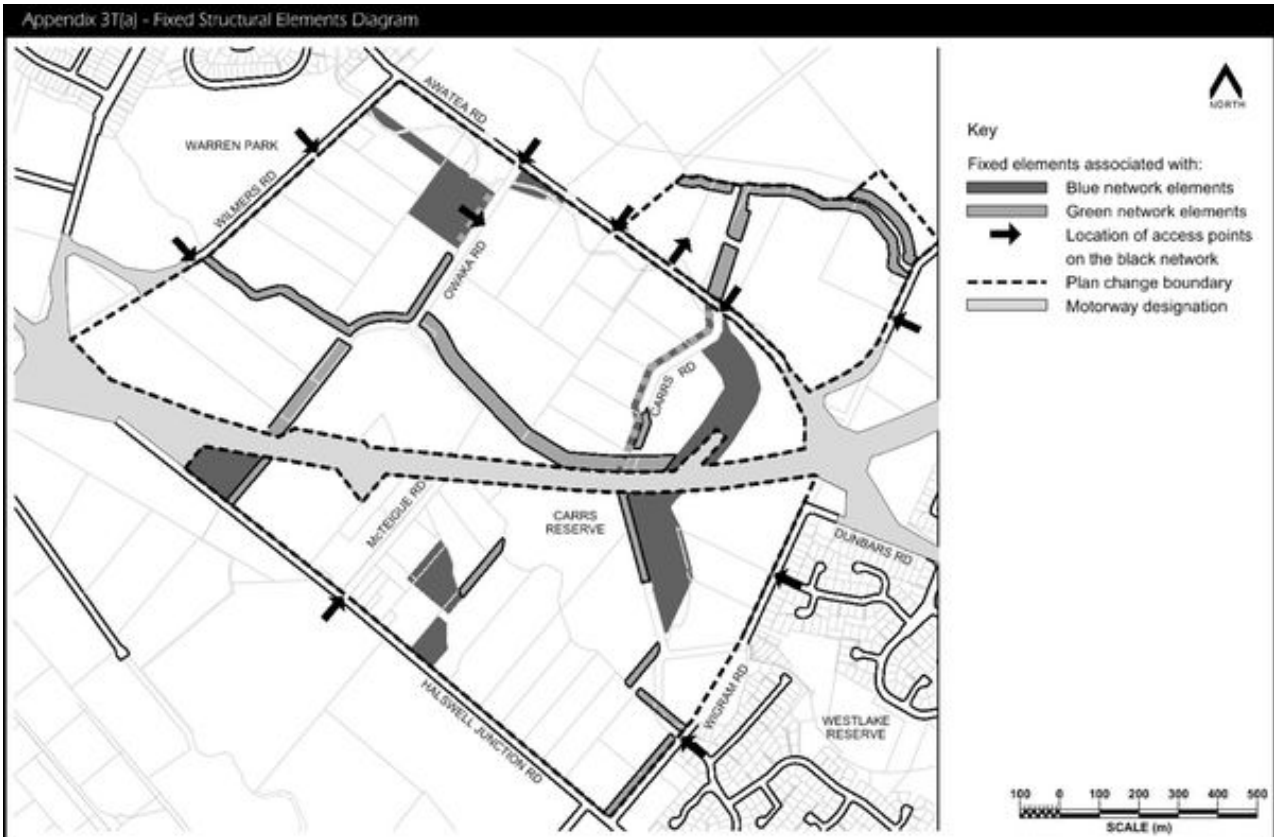

Appendix 3T(i) - Green Network Layer Diagram (Awatea)

Updated 11 July 2011

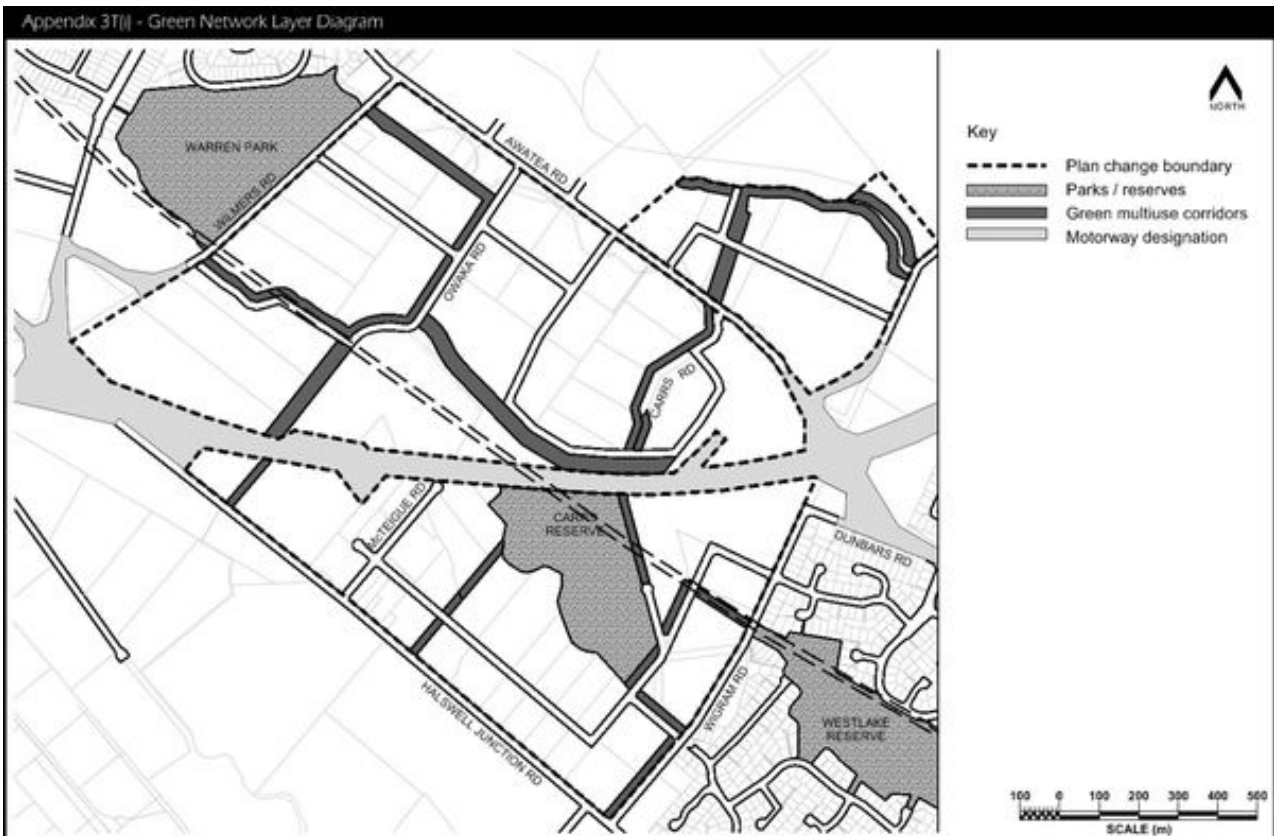

Appendix 3T(ii) - Blue Network Layer Diagram (Awatea)

Updated 11 July 2011

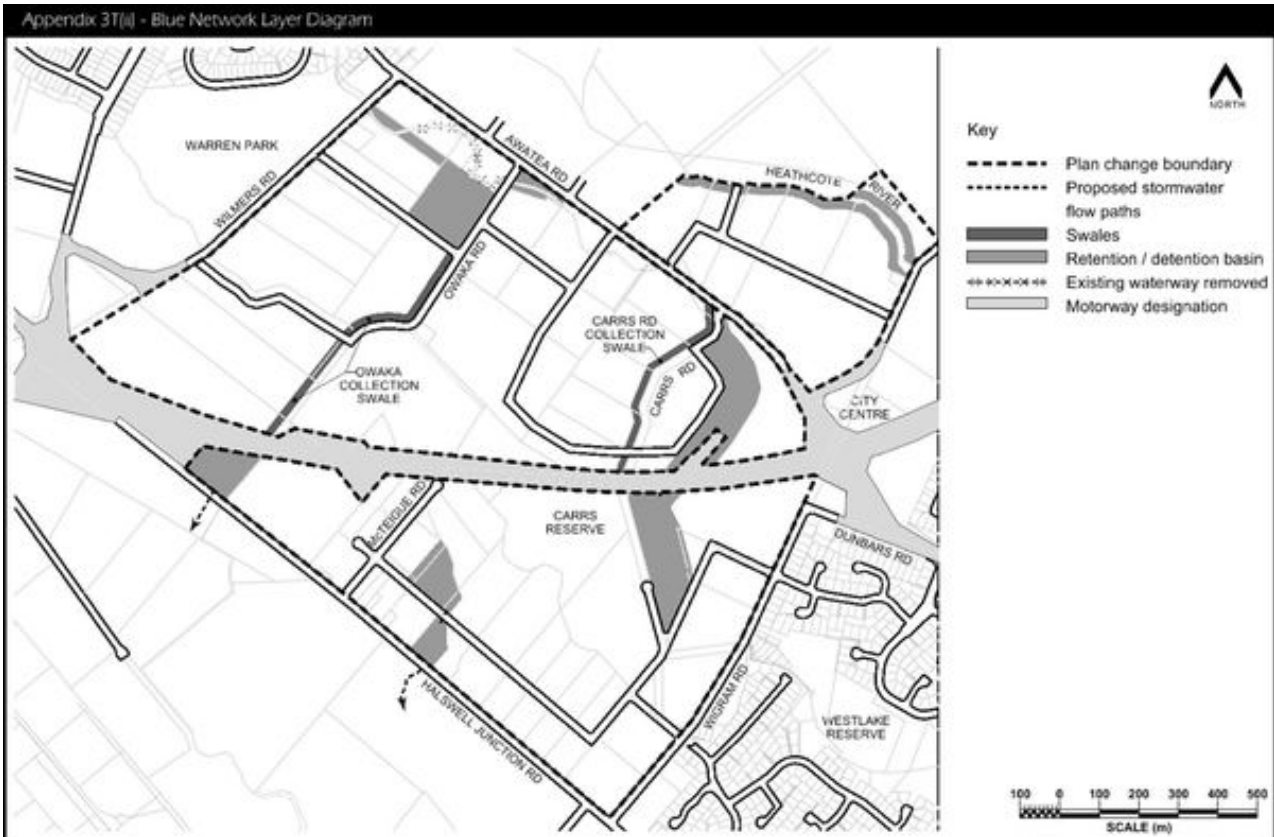

Appendix 3T (iii) - (vi) - Movement Network Layer Diagram (Awatea)

Updated 11 July 2011

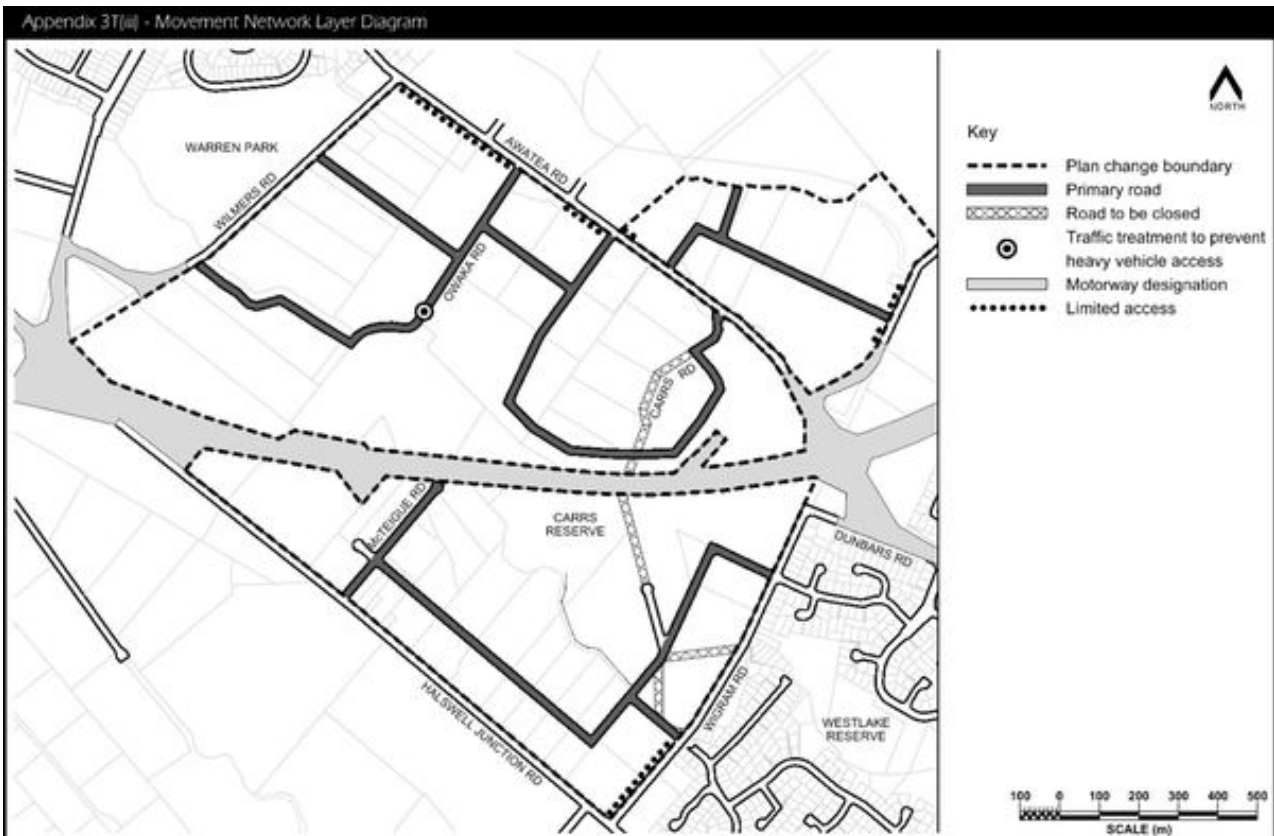

Appendix 3T(M) - Cycle Network Diagram

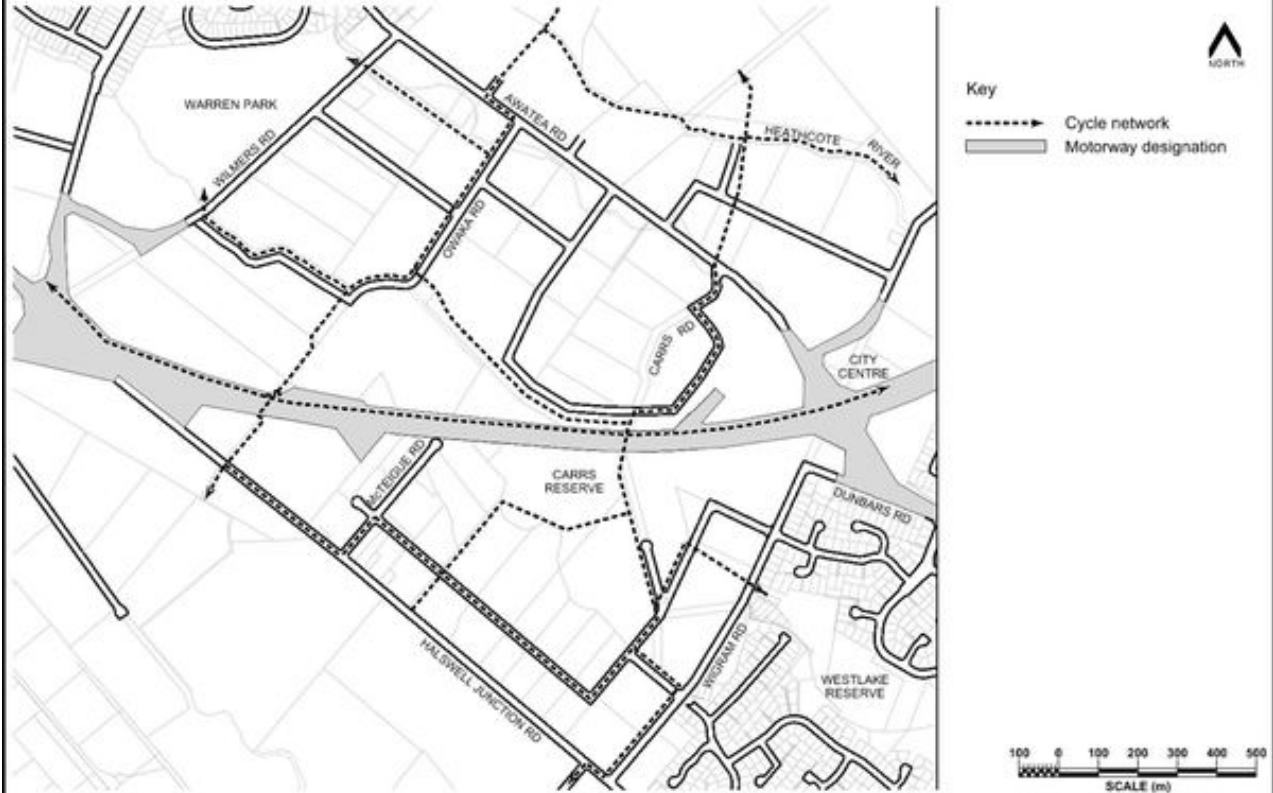

Appendix 3T(N) - Public Transport Diagram

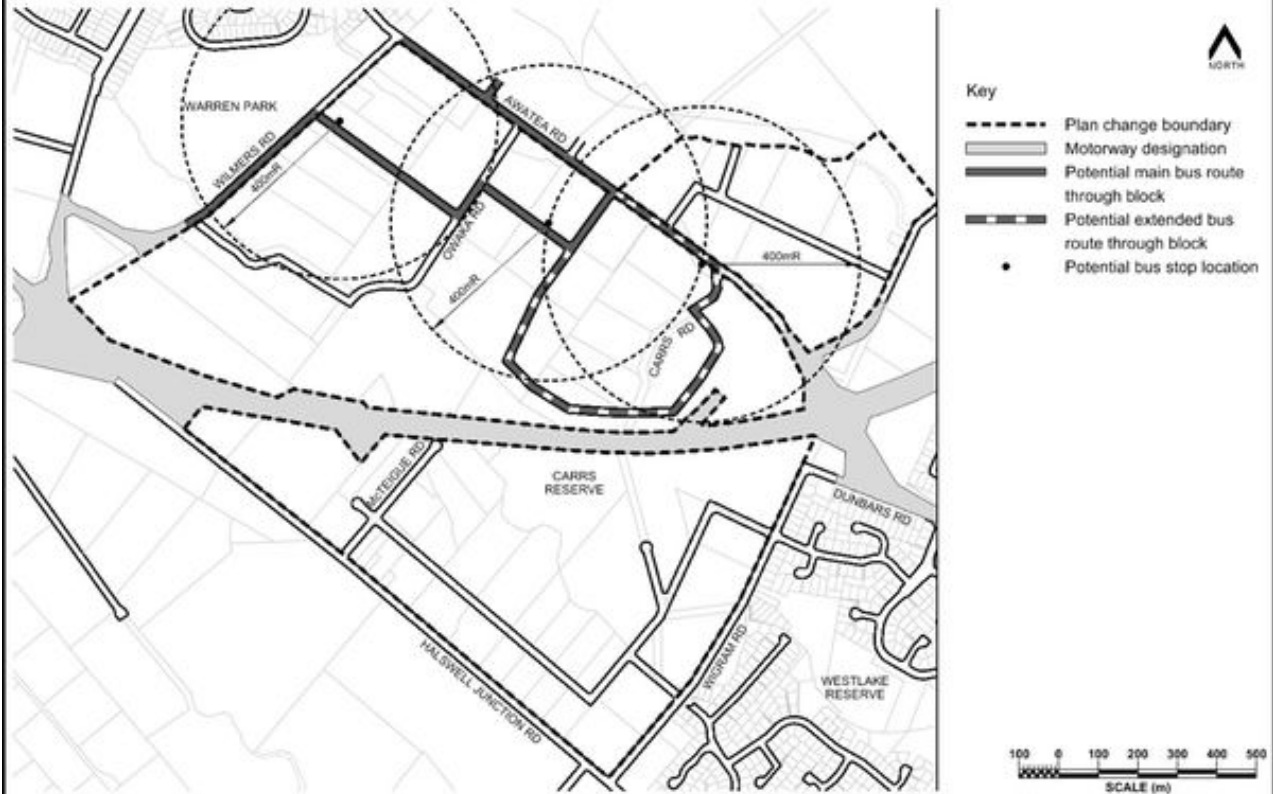

Appendix 3T(vi) - Road Design Parameters

Table 1: Minimum Design elements for Local Roads in residential areas

Street Type	Minimum legal road width	Indicative legal road width	Minimum carriageway width	Minimum number of footpaths	Minimum footpath width	Provision of street trees	Minimum level of amenity coverage Note (1)	Minimum on-street parking requirement	Driveway spacing Parameter	
									Res A	Res B & C
Short local street	12m	Note (2)	6.0m	1	1.5m	Yes	25%	1 space for every 3 residential units	0.75	0.80
Typical local street	15m	Note (2)	7.5m	2*	1.5m	Yes	20%	1 space for every 3 residential units	0.75	0.80
Local distributor street	17m	Note (2)	9.0m	2*	1.5m	Yes	20%	1 space for every 3 residential units	0.75	0.80
Local street (bus route)	18m	Note (2)	9.5m	2	1.5m	Yes	20%	1 space for every 3 residential units	0.75	0.80

Table 1 Notes

- (1) The minimum portion of legal road width that is designated for community features. Amenity on all local streets shall be provided continuously on both sides of the street, only broken by vehicle or path crossing points.
- * Two footpaths are required except for sections of streets with frontage to Conservation, Open Space or Rural Zones where one footpath may be provided within the legal road. Where one footpath is provided, it must be located on the residential side of the street.
- (2) See calculation formula below to determine Indicative Legal Road Width where amenity coverage is provided continuously or in discrete clusters.
- Res A - High Density Residential A Area.
Res B - Medium Density Residential B Area.
Res C - Low Density Residential C Area.

Table 2: Minimum Design elements for Primary and Collector Roads

Zoning	Minimum legal road width	Indicative legal road width	Minimum traffic lane width Note (3)	Minimum number of footpaths	Minimum footpath width	On street cycle lanes Note (4)	Provision of street trees	Minimum level of amenity coverage Note (5)	Driveway spacing Parameter
Business 7 zone	22m	Note (6)	3.2m	2	1.5m	Yes	Optional	5% or 50m ²	0.90
All living zones	20m	Note (6)	3.0m	2	1.5m	Yes	Yes	10%	Res A - 0.75 Res B - 0.80 Res C - 0.80
All other zones	19m	Note (6)	3.0m	2	1.5m	Yes	Optional	5% or 50m ²	0.95

Table 2 Notes

- (3) The minimum traffic lane width shall be increased to 3.2m if the primary or collector road forms part of a bus route.
- (4) On street cycle lanes shall be designed in accordance with the NZ supplement to Austroads Guide to Traffic Engineering Practice Part 14: Bicycles.
- (5) Where amenity is provided continuously the specific percentages shall apply. Where amenity is provided in discrete clusters the area (per 100m lineal length of road) shall apply.
- (6) See calculation formula below to determine Indicative Legal Road Width where amenity coverage is provided continuously or in discrete clusters.
- Res A - High Density Residential A Area.
Res B - Medium Density Residential B Area.
Res C - Low Density Residential C Area.

Terminology

Local Short Street	All streets in the Living G Zone that are less than 150m in length and serve a maximum of 25 potential residential units.
Local Typical Street	All streets that do not meet the criteria of a Local Short Street or Local Distributor Street.
Local Distributor Street	All streets that intersect with a Collector, Minor or Major Arterial Road and have intersections with at least two other Local Typical Streets.
Local Street (Bus Route)	Any of the above Local Streets that forms part of a future bus route.

Indicative Legal Road Width Formula

On streets where amenity is provided continuously, the indicative legal road width shall be calculated using the following formula:

$$\text{Indicative Legal Road Width (Continuous Amenity)} = (A + B) / (1 - (C / D))$$

Where:

- A = proposed carriageway width (in metres)
- B = proposed combined width of footpaths (in metres)
- C = minimum level of amenity coverage (expressed as a decimal)
- D = driveway spacing parameter (expressed as a decimal)

On streets where amenity is provided in discrete clusters, the indicative legal road width shall be calculated using the following formula:

$$\text{Indicative Legal Road Width (Discrete Amenity)} = (A + B) / (1 - C)$$

Where:

- A = proposed carriageway width (in metres)
- B = proposed combined width of footpaths (in metres)
- C = minimum level of amenity coverage (expressed as a decimal)

Appendix 3T(vii) - Tangata Whenua Layer Diagram (Awatea)

Updated 11 July 2011

Appendix 3T(vii) - Tangata Whenua Layer Diagram

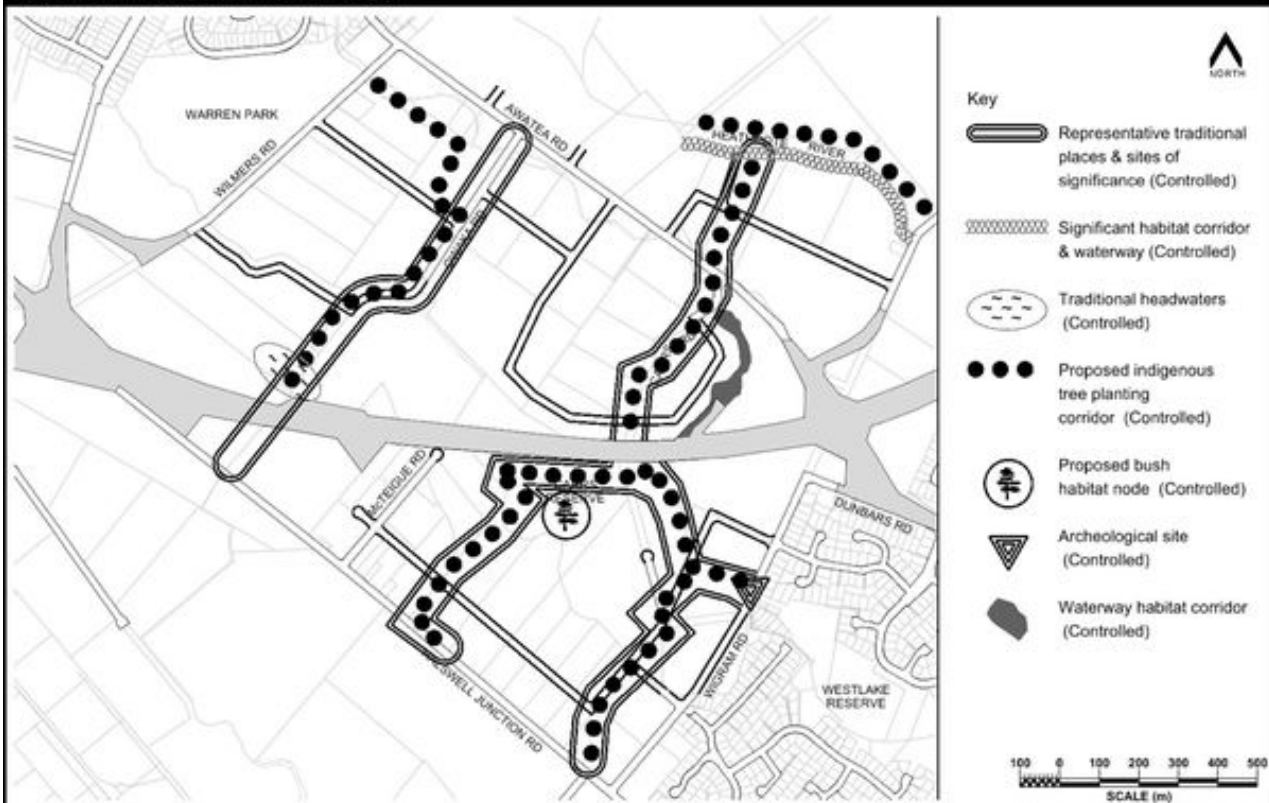

Appendix 3U/1 Outline Development Plan (Wigram)

Updated 12 September 2011

Appendix 3U/1 Outline Development Plan (Wigram)

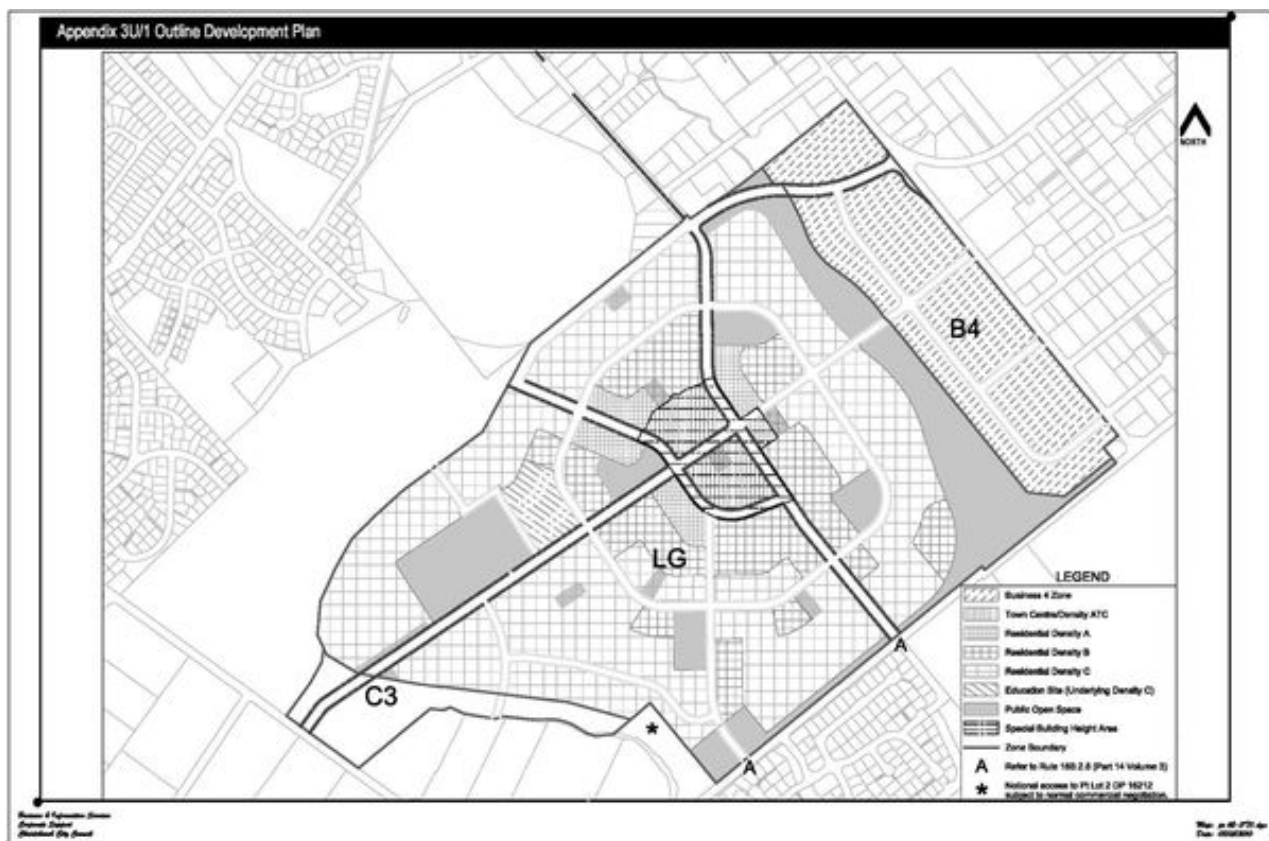

Appendix 3U/2 - Key Structuring Elements (Wigram)

Updated 12 September 2011

The structuring elements, which underpin the Outline Development Plan and which will enable a sound social, environmental and economic outcome to be achieved, include the following:

- Development of residential densities similar in scale to surrounding properties with increased density towards the centre of the site within walking distance of bus stops and/or facing open space reserves.
- Subdivision and landuse patterns that can accommodate a minimum of 1300 dwellings.
- A centrally located town centre that can accommodate retail, commercial, civic, community and higher density residential uses.
- The ability to provide a landmark building or buildings with elements of additional height in the town centre.
- The provision of a light industrial/commercial area to the east which also act as a buffer (in association with Wigram Park) to the Parkhouse Industrial area.
- The provision of a school site and a nearby sports park that fronts onto the Runway Boulevard.
- A movement network that provides effective pedestrian, cycle, private/public transport and therefore has a high level of connectivity within the site and to the surrounds.
- Provision of accessible open space to provide for the recreational and social needs, of the community as well as landscape amenity, stormwater management, the Heathcote River/Haytons Drain environs, and pedestrian and cycle linkages.
- The integration of stormwater management with waterways, the movement network and open space.
- The provision for and recognition of values important to tangata whenua in particular the establishment of enhanced waterways as an ecological asset and the protection of water quality in accordance with the Christchurch City Council South West Area Plan.

Appendix 3U/3 - Layer Diagram - Green Network (Wigram)

Updated 12 September 2011

Green Network

This refers to the system of public open space provision throughout the site and is shown in Figure 1. These spaces offer a wide range of amenity/recreational experiences and their location and alignment are closely linked to the movement network, underlying land uses and the blue network in respect of storm water management and public access. Public open space reserves include:

Sports Park: A sports park (approximately 4ha) will be provided adjacent to the Runway Boulevard and School site to provide a strong complimentary relationship. The Sports Park should incorporate facilities for sports clubs as well as playing fields and pitches.

The Town Square: The town square will be provided to help act as a centre of community life and a key place in the community. It aims to be the catalyst of activity adjacent to the retail area and provide the opportunity to celebrate and support local culture and community. The square may be activated by mixed use, community and civic activities.

Neighbourhood Parks: Four evenly distributed Neighbourhood Parks (approximately 1ha each) will be provided to maximize their accessibility to residents and located on either the Loop Road or Runway Boulevard to help consolidate the open space character of Wigram.

Smaller Neighbourhood Parks: Where possible Smaller Neighbourhood Parks will be established to provide for the recreational and amenity needs of higher residential density areas and to encourage social interaction, meeting and informal gathering within smaller community clusters.

Wigram Park: Wigram Park (approximately 15ha) will be a key community and regional open space connecting through the site and accommodating Haytons drain. The open space will also accommodate stormwater infrastructure and help form a buffer between the residential area and the Business 4 and Business 5 zones. The provision of open space to accommodate Haytons drain will provide an opportunity to protect and enhance ecological and tangata whenua values and restore wildlife habitat.

A key feature of Wigram Park is the provision of open space to provide a 50m wide amenity setback from the Business 5 Zone that adjoins the Outline Development Plan area. This feature is primarily provided to protect the amenity of residents to the south of the Parkhouse Road extension. A solid vegetation screen (landscape strip) should be established along the boundary to the Business 5 Zone along with additional landscaping in the wider open space area to avoid reverse sensitivity effects on residents and also users of the road and Wigram Park

Conservation 3 land: The land zoned for Conservation 3 purposes (approximately 6.8ha) will form part of a larger open space area for the Heathcote River and stormwater infrastructure. The provision of open space to accommodate the Heathcote River and will provide an opportunity to protect and enhance ecological and tangata whenua values and restore wildlife habitat.

Open Space for Landscape Strip. This open space is to be provided with a vegetated landscaping strip to screen adjacent buildings and activities on Business 5 Zone land from the Living G (Wigram) Zone.

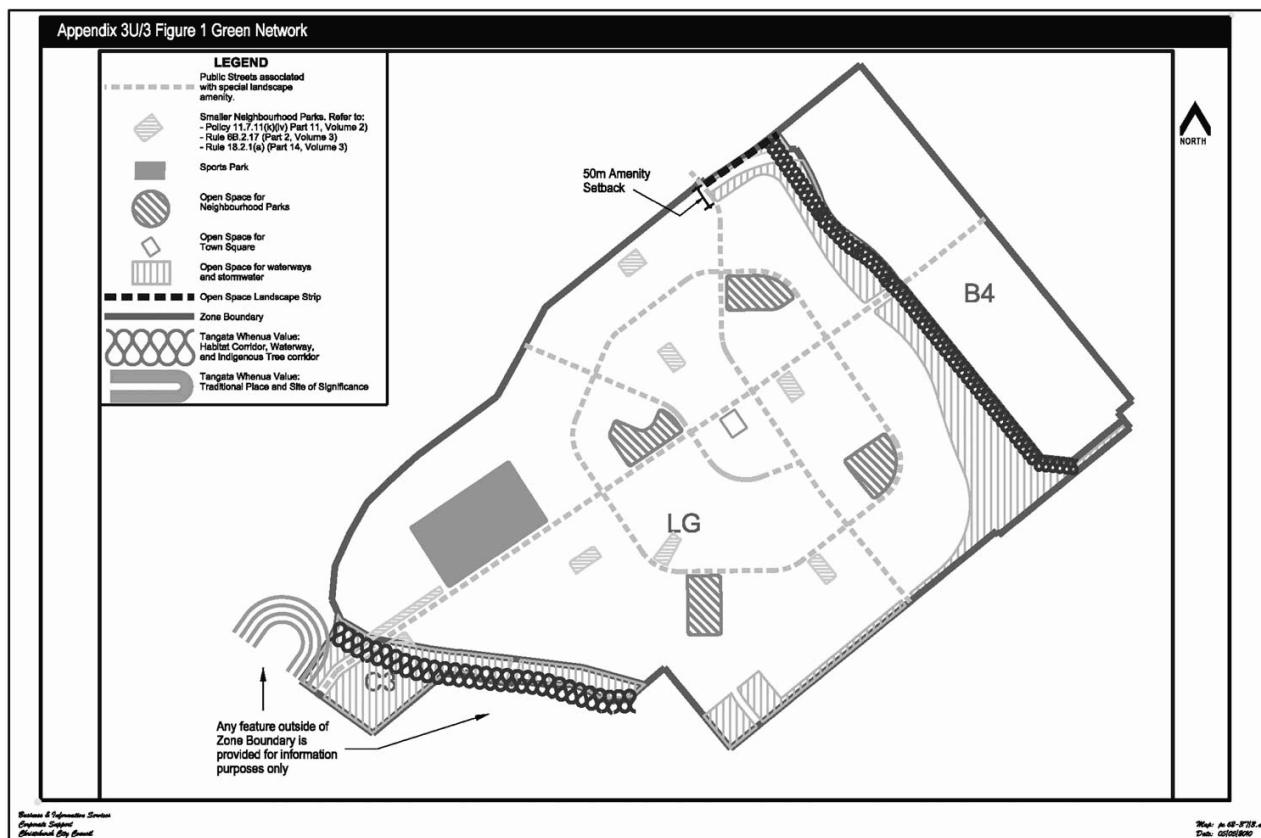

Appendix 3U/4 - Layer Diagram - Movement Network (Wigram)

Updated 12 September 2011

1. Movement Network

This refers to the network of public roads, cycle ways, pedestrian pathways and linkages through and to the site. The network has an important relationship with the underlying land use patterns, and also has a strong correlation with the green and blue networks in respect of pedestrian and cycleway linkages. The following describes the key elements of the movement network for Wigram.

2. Road Network

This refers to the hierarchy of proposed public roads across the site. The distribution of landuses and residential densities across the site is closely tied to this hierarchy. In particular, the Town Centre is well connected by Collector Roads from surrounding areas so that it provides the focal point of the development. The supporting local road network is then used to connect the neighbourhoods with each other and with the Town Centre. The proposed network has also been designed in order to integrate with the green and blue networks as these also provide essential pedestrian and cycle way linkages. The following describes the key elements of the road network:

(1) Road Hierarchy

The Road Hierarchy is illustrated in Figure 2. Collector Roads form the primary routes through Wigram and provide legible extensions of, and connections between, existing through routes in the surrounding area to ensure a high level of integration. These Collector Roads pass through the Town Centre to support its development as the focal point of Wigram. Other roads not shown on Figure 2, will typically be "Local - Residential" and "Local - Neighbourhood" roads which principally provide residential property access. Arterial routes are not proposed to be used within Wigram as this function is provided by the surrounding network.

(2) Collector Roads

The Collector Roads provide the primary traffic carrying function within and through Wigram, with a focus on providing for all modes of transport including public transport (where applicable). Key collector roads are illustrated in Figures 3 and 3a and are described below:

- **Wigram Boulevard** - a Boulevard located on the alignment of the former airfield runway, being a key feature of Wigram. It will connect between Awatea Road, the Town Centre and the Business 4 Zone. The road will be designed with a wide central landscaped median (potentially with a stormwater function) and the formation will accommodate vehicular, cycle and pedestrian movements. The road will also accommodate the primary bus route west of the town centre. Traffic management measures are proposed for the eastern end of the Boulevard to minimise the potential for industrial traffic to use the Boulevard as a through route. It is noted that the section of the Boulevard between the Business 4 Zone and the Town Centre has been allocated local road status to help minimise the extent of industrial traffic existing through residential areas and the Town Centre.
- **Main Street** - within the town centre the characteristics of the Runway Boulevard will transform into a space shared by all modes of transport with a particular focus on pedestrians and the provision of a public transport node.
- **Corsair Drive Extension** - the extension of Corsair Drive to the town centre will provide a link to the north and west. The road will be designed to accommodate vehicular, cycle and pedestrian movements. The use of a flush median is included where necessary to provide for intersection and property access turn movements.

- **Aidanfield Drive Extension** - the extension of Aidanfield Drive to the town centre will provide a key link to arterial routes via Wigram Road and the suburbs in the southwest. The road will include a central landscaped median (potentially with a stormwater function) and will be designed to accommodate vehicular, cycle and pedestrian movements. This road should form the first new road link to Wigram Road, forming the fourth leg to the proposed roundabout or traffic signals at the Wigram Road / Aidanfield Drive intersection. Its intersection with Wigram Road should provide for boundary splays to accommodate the proposed intersection and if it precedes the construction of the intersection as a roundabout or traffic signal control, then a standard right turn bay from the north is to be constructed.
- **Vickers Road Extension** - Vickers Road is to be upgraded as the primary link between the Parkhouse Industrial area and Main South Road. This link will provide access to the town centre from the north and will also form part of a north-south through route with the Aidanfield Drive Extension. The link will form part of the proposed bus route servicing Wigram.
- **Parkhouse Road Extension** - Parkhouse Road will be extended to the Vickers Road extension to provide a key link from Wigram towards the City. It will also form the primary route for industrial traffic accessing Main South Road from the Parkhouse Industrial area. The connection of the Parkhouse Road Extension to Parkhouse Road should be made as a roundabout controlled intersection with Hayton Road. The use of a flush median is included where necessary to provide for intersection and property access turn movements.

(3) Local Roads

The types of local roads that should be provided are detailed below, with the location of key local roads also included in Figures 2 and 3a:

- **Avenue (Loop Road)** - a local road providing a ring around the town centre with an emphasis on providing a 'green' route for connecting the community and providing efficient connections to the collector network. Parts of the Avenue may include a stormwater corridor
- **Local Distributors** - local roads providing a function of connecting neighbourhoods and providing access to collector roads by allowing locally based through travel. Should be used for situations with increased parking and/or traffic demand.
- **Residential Access** - residential local roads with relatively frequent parking on both sides to assist speed control. Designed to provide for the width of three vehicles (including parking).
- **Neighbourhood** - narrow streets with low parking demand and low traffic volumes, typically away from activity areas, and with short lengths no greater than 200m. Designed to provide for the width of two vehicles (including parking) where the staggered parking will assist with the traffic calming of the streets.

Note: The residential access and neighbourhood roads are not included in Figures 2 and 3a to ensure there is sufficient future flexibility in the design of the road network and general neighbourhood structure. However, a key focus of those roads is to ensure that speeds are minimised through narrow carriageways facilitating shared use with cyclists and pedestrians.

(4) Limited Access to Wigram Road

Access to Wigram Road is restricted to the road connections shown on Figure 2. This is to protect the future arterial function and recognise that there will be limited points of access on the southern side of Wigram Road.

(5) Heavy Vehicles

The road network will minimise heavy vehicle traffic from the adjacent Business 4 and 5 Zones travelling through the Town Centre and residential areas.

(6) Cross - Sections

Figures 3(a) and (b) detail typical cross-sections for the Road Network. In close proximity to the Town Centre and Density A areas, the amenity provisions of the cross-sections may vary from those detailed to ensure that optimal integration with the built environment is made.

(7) On - Street Parking

On-street parking will be provided where practical. Consideration should be given to designing the parking provision on roads (generally excluding residential and neighbourhood roads) so that long stretches of visually wide carriageway are not created. Methods to achieve this include indenting parking bays into landscaping and providing variation of materials for the purposes of legibility and visual interest.

3. Public Transport Network

This refers to the bus route options across the site. The proposed network options are aimed at encouraging the use of public transport and maximising user patronage. This has the ability to reduce reliance on private vehicle ownership. The following describes the key elements of the public transport network:

(1) Bus Routes

Figure 1 provides routes within the transport network that are capable of accommodating two bus route options through the site.

(2) Primary Bus Route

The Primary Bus Route is generally aligned along the Collector Roads linking Parkhouse Road to Awatea Road, with a primary public transport node in the Town Centre where changes in travel mode are provided for. Further intermediate bus stops are to be located to maximise access to the number of dwellings/lots within a 500m walking distance.

(3) Secondary Bus Route

The Secondary Bus Route is protected for efficient future retrofitting in case demand increases warrants its implementation. It should generally be aligned along the Collector Roads linking Wigram Road / Aidanfield Drive to Springs Road / Corsair Drive, via the Town Centre public transport node. Adoption of the cross-sections in Figure 3(a) and (b) enable this efficient retrofitting.

4. Cycle Network

This refers to the system of cycle ways, cycle paths and linkages to and through the site. This network has a relationship with the underlying movement network and as such is integrated with the green and blue networks. There are two key types of priority cycle routes proposed (on street cycle lane and shared off-street cycle/pedestrian paths). Other streets within the development should be considered as cycle compatible due to envisaged low design speeds and low traffic volumes. The following describes the key elements of the public transport network:

(1) Priority Routes

Priority cycle routes (onstreet cycle lane and shared off-street cycle/pedestrian paths) are to be provided through and within the site that are well connected to the surrounding network and safe, generally in accordance with Figure 5.

(2) Secondary Routes

Other streets within the development should be considered as cycle compatible due to envisaged low design speeds and low traffic volumes

5. Pedestrian Network

This refers to the system of pedestrian footpaths and linkages to and through the site. This network has a relationship with the underlying movement network and land uses and as such is also integrated with the blue and green networks. The following describes the key elements of the Pedestrian Network:

(1) Town Centre

The pedestrian network makes provision for a clear pedestrian focused routes through the town centre/town square where there is a high level of supervision and natural street activity.

(2) Priority Routes

Priority pedestrian routes will be to be provided through and within the site that are well connected to the surrounding network and safe, generally in accordance in Figure 5.

Appendix 3U/4 Figure 2 Road Hierarchy (Wigram)

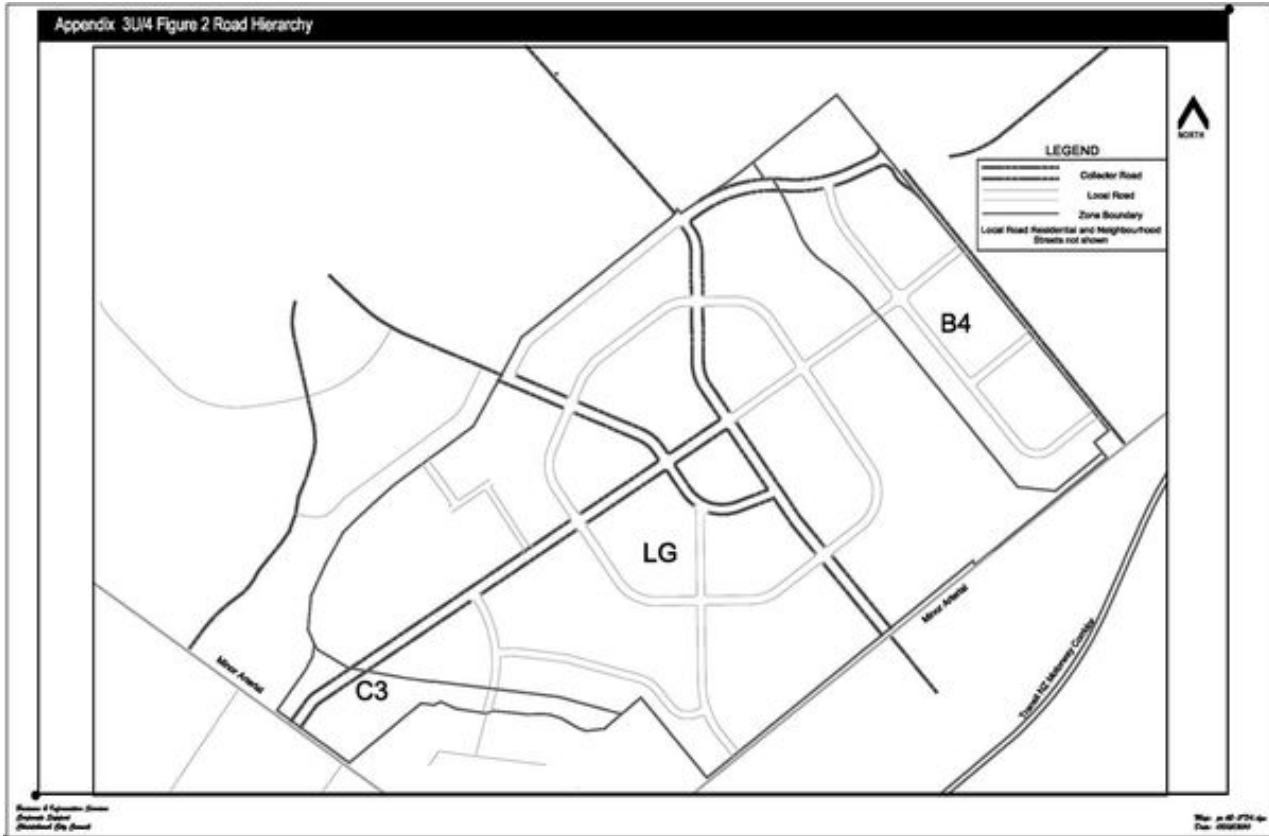

Appendix 3U/4 - Figure 3a Cross Section Reference (Wigram)

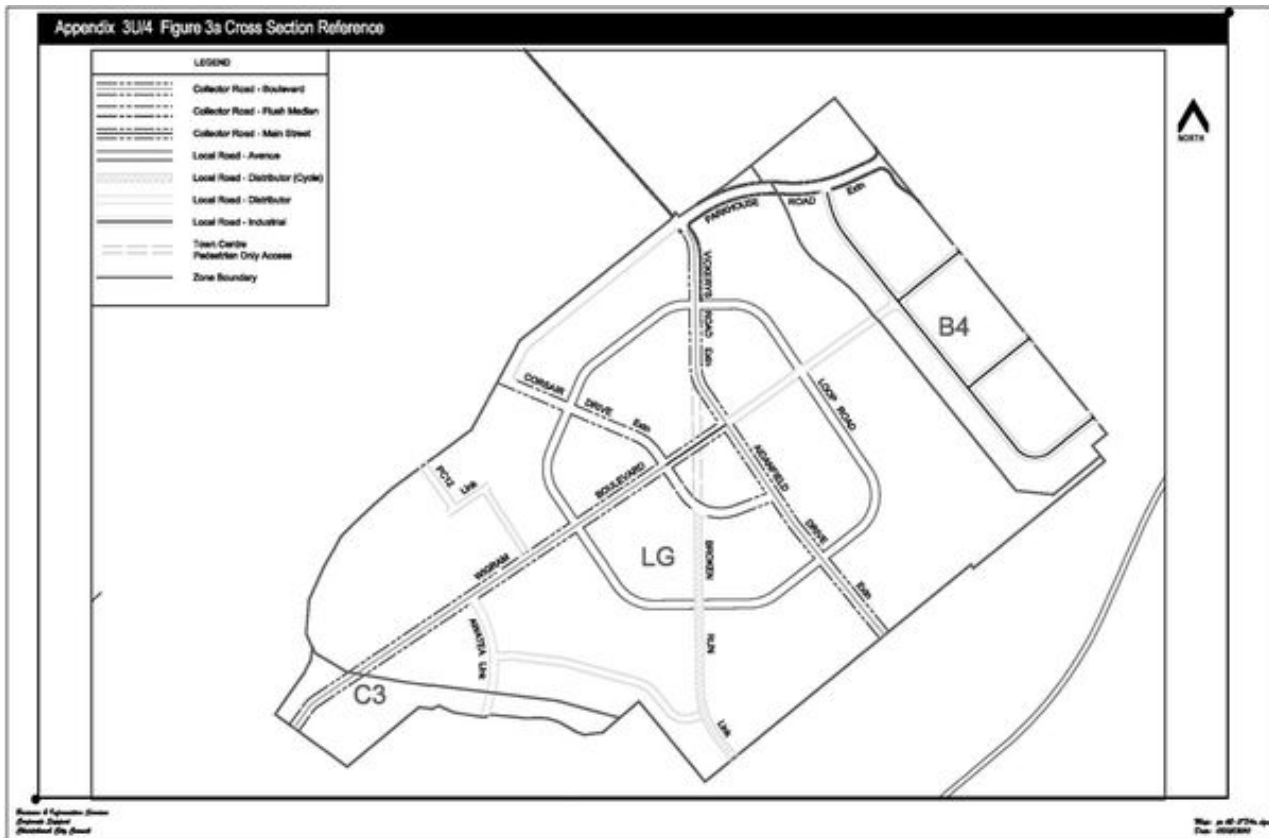

Appendix 3U/4 - Figure 3b Typical Cross Sections (Wigram)

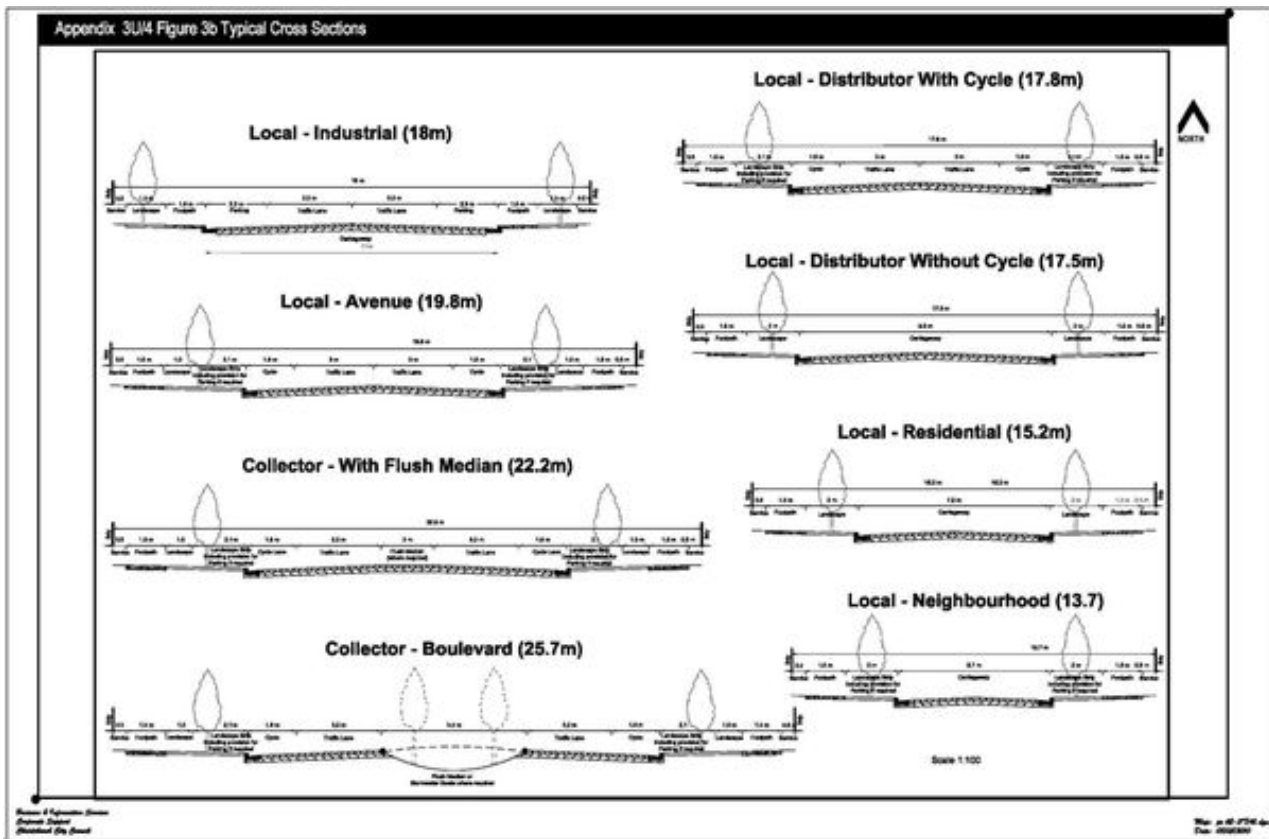

Appendix 3U/4 - Figure 4 Public Transport Network (Wigram)

Updated 12 September 2011

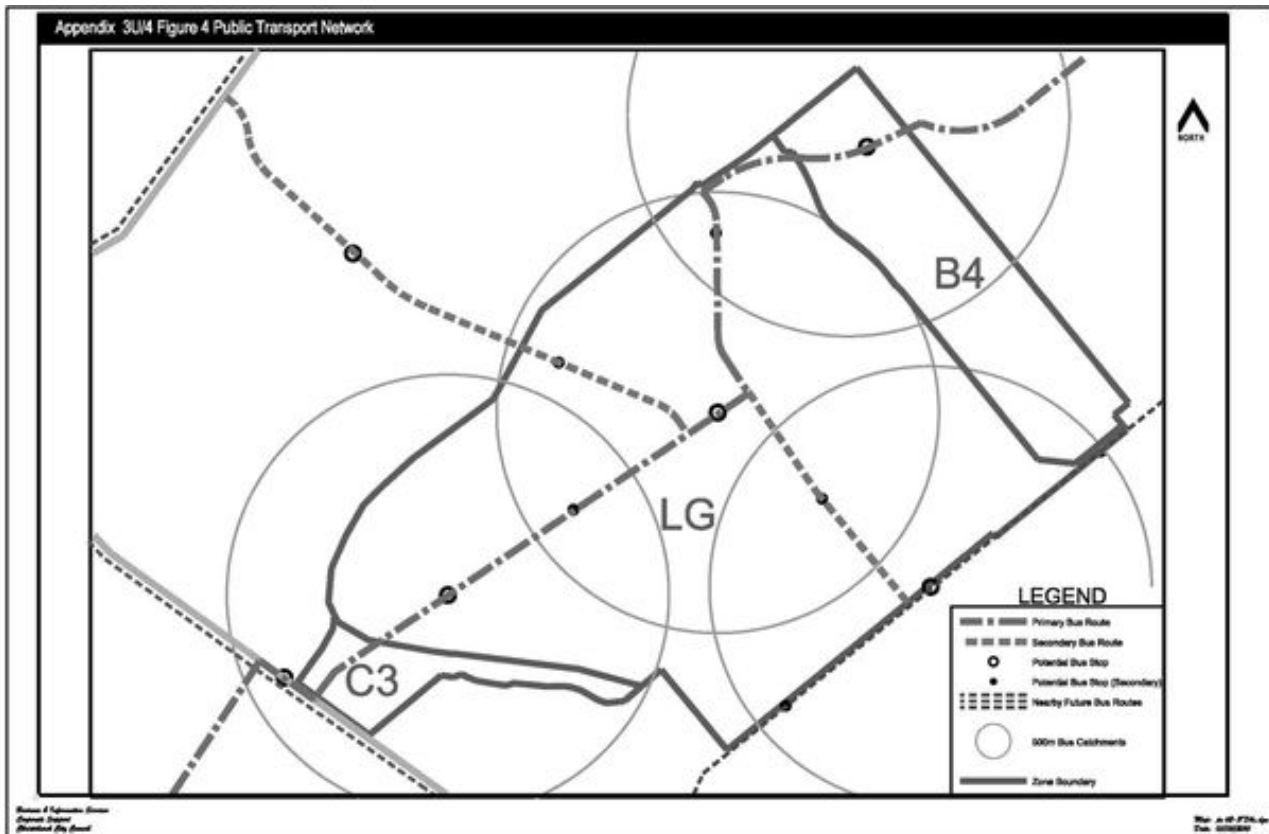

Appendix 3U/4 - Figure 5 Cycle and Pedestrian Network (Wigram)

Updated 12 September 2011

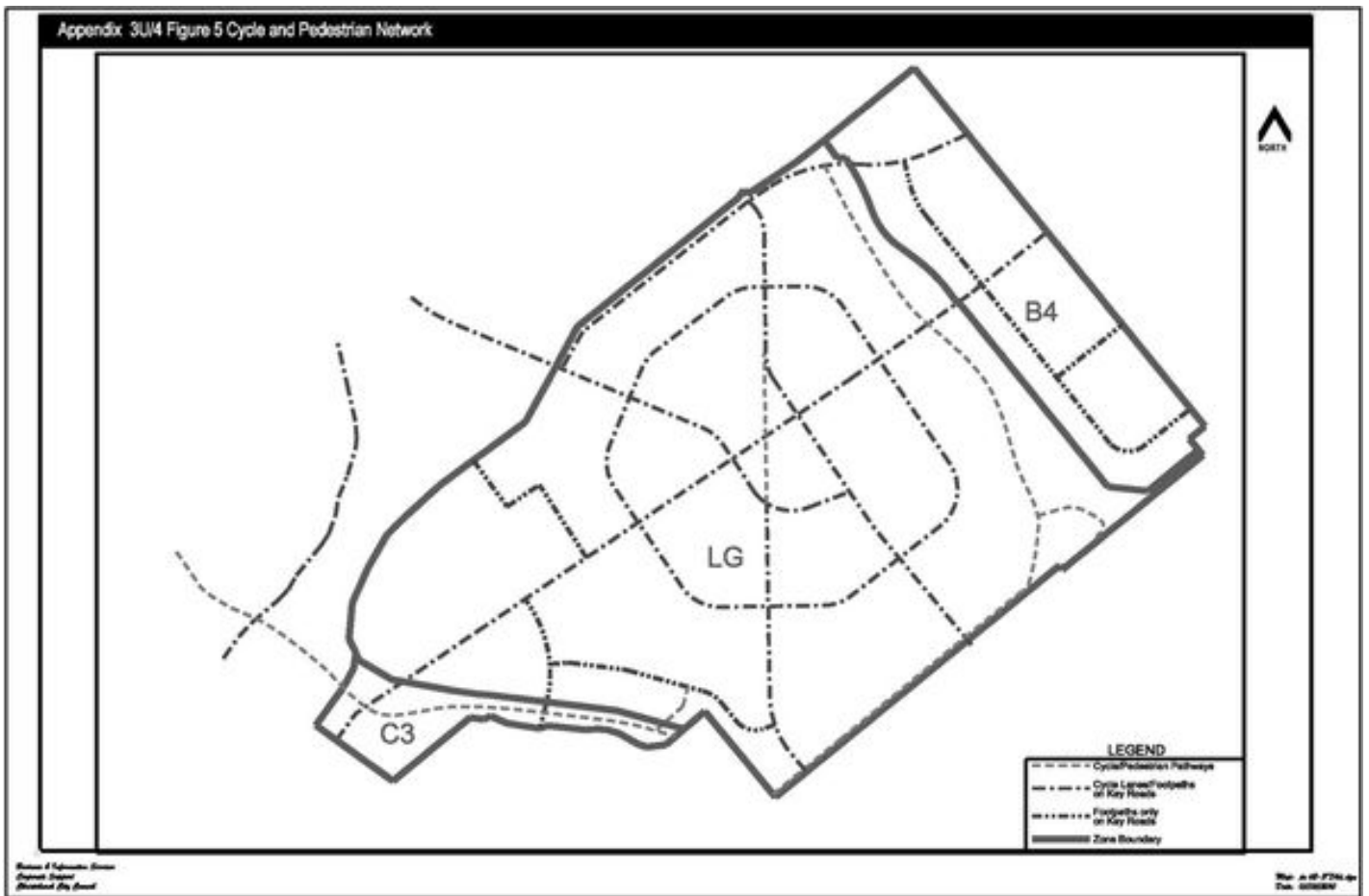

Appendix 3U/5 - Layer Diagram - Blue Network (Wigram)

Updated 30 April 2011

Blue Network

This refers to the above ground system designed in order to help meet the site's future anticipated storm water quality and quantity requirements. These include swales and flow paths as well as detention/soakage facilities within the public open spaces linking and containing the Heathcote River and realigned Haytons Drain. The key elements of this system are identified on Figure 6. All stormwater systems will be designed in a manner which recognises the values important to tangata whenua particularly in regards to enhancing ecological values and water quality associated with the Heathcote River and Hayton Drain.

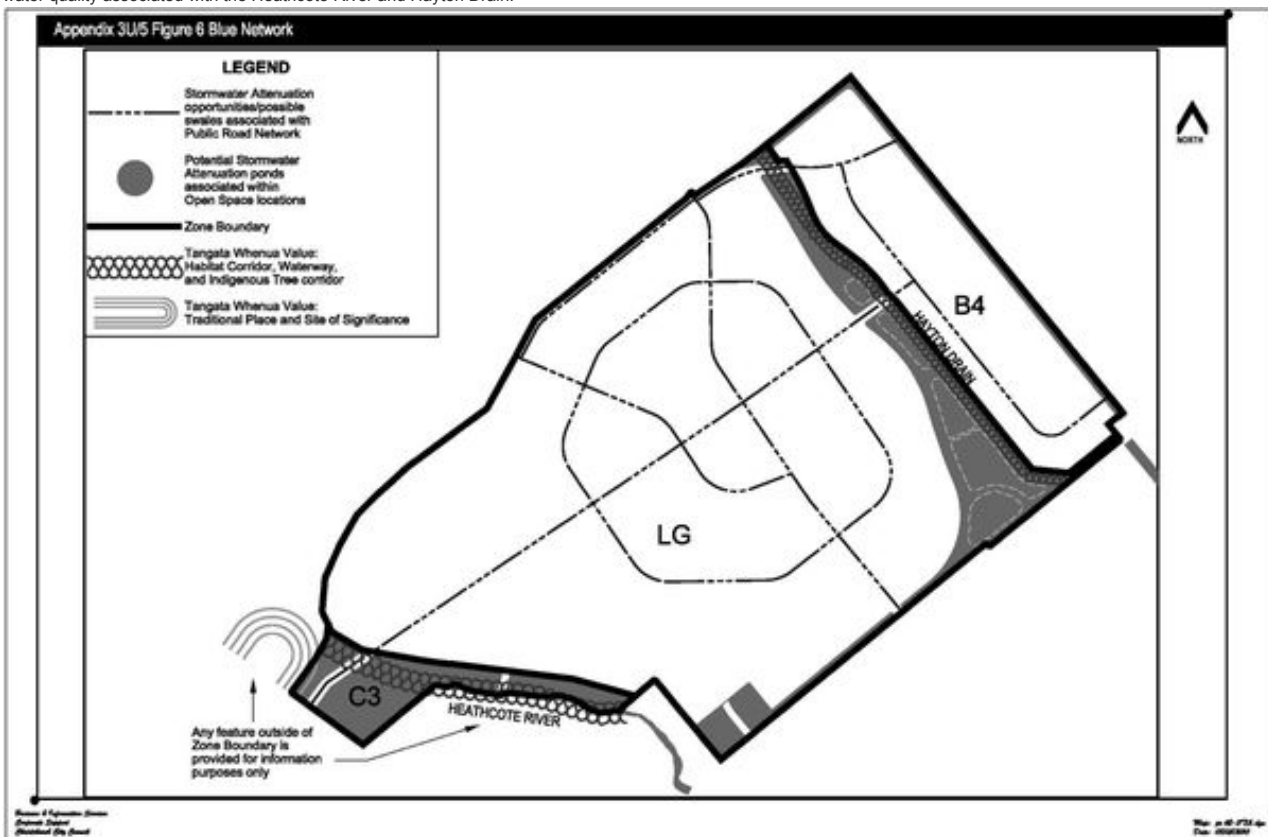

Appendix 3V - Zoning Plan (Prestons)

Updated 1 November 2011

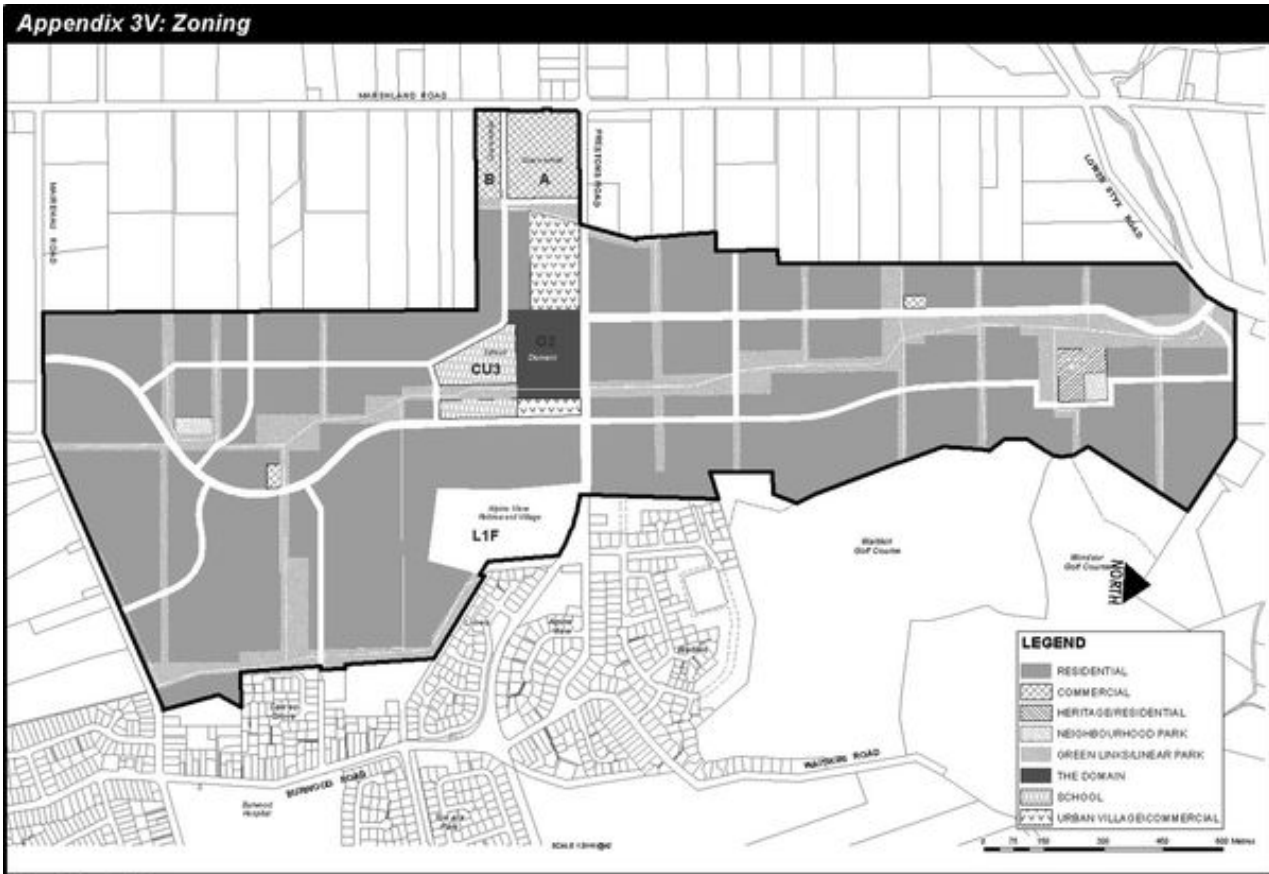

Business & Information Services
Corporate Support
Strategic City Council

Map 7-04_20-06.dwg
Date: 09/11/2011

Appendix 3V/1 - Outline Development Plan (Prestons)

Updated 1 November 2011

Appendix 3V/1: Outline Development Plan (Prestons)

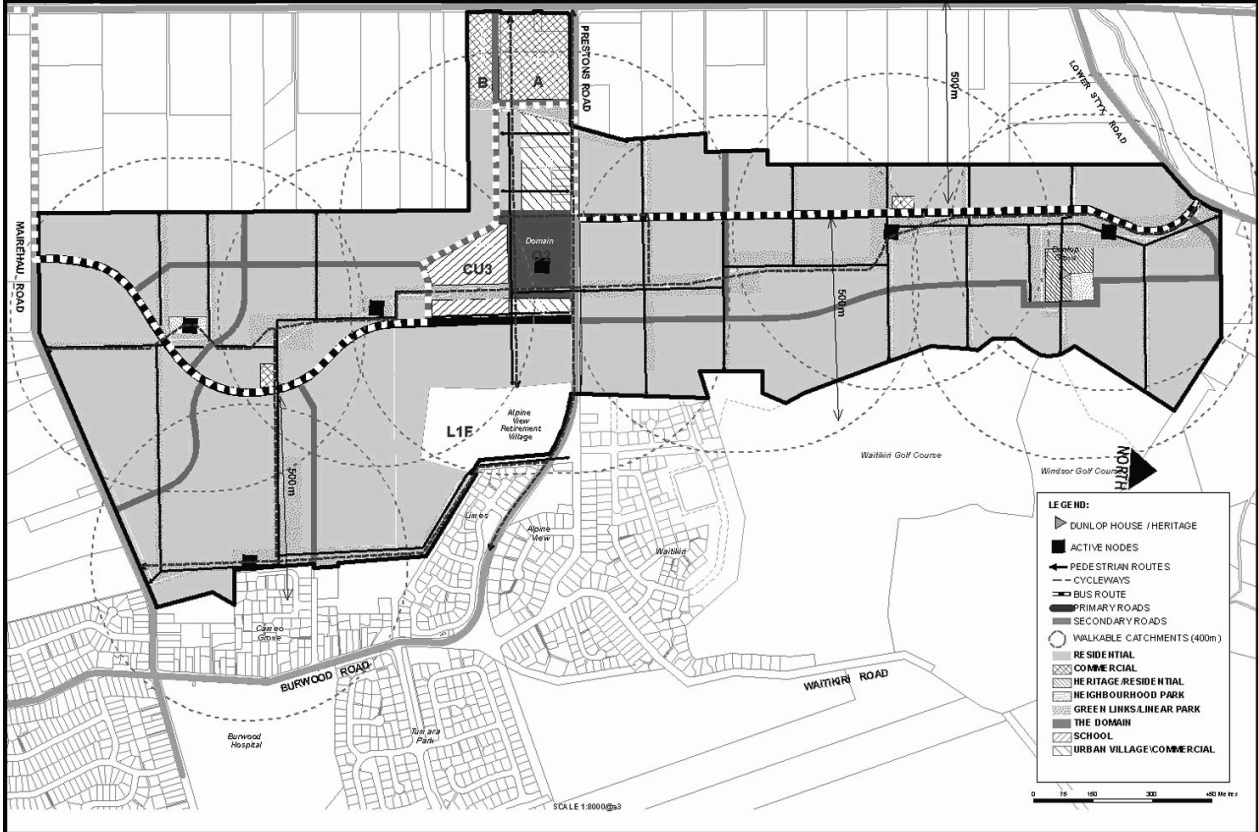

Business & Information Services
Corporate Support
Christchurch City Council

Map : pc_3V-02.gws
Date : 09/11/2011

Appendix 3V/2 - Density Layer Diagram (Prestons)

Updated 1 November 2011

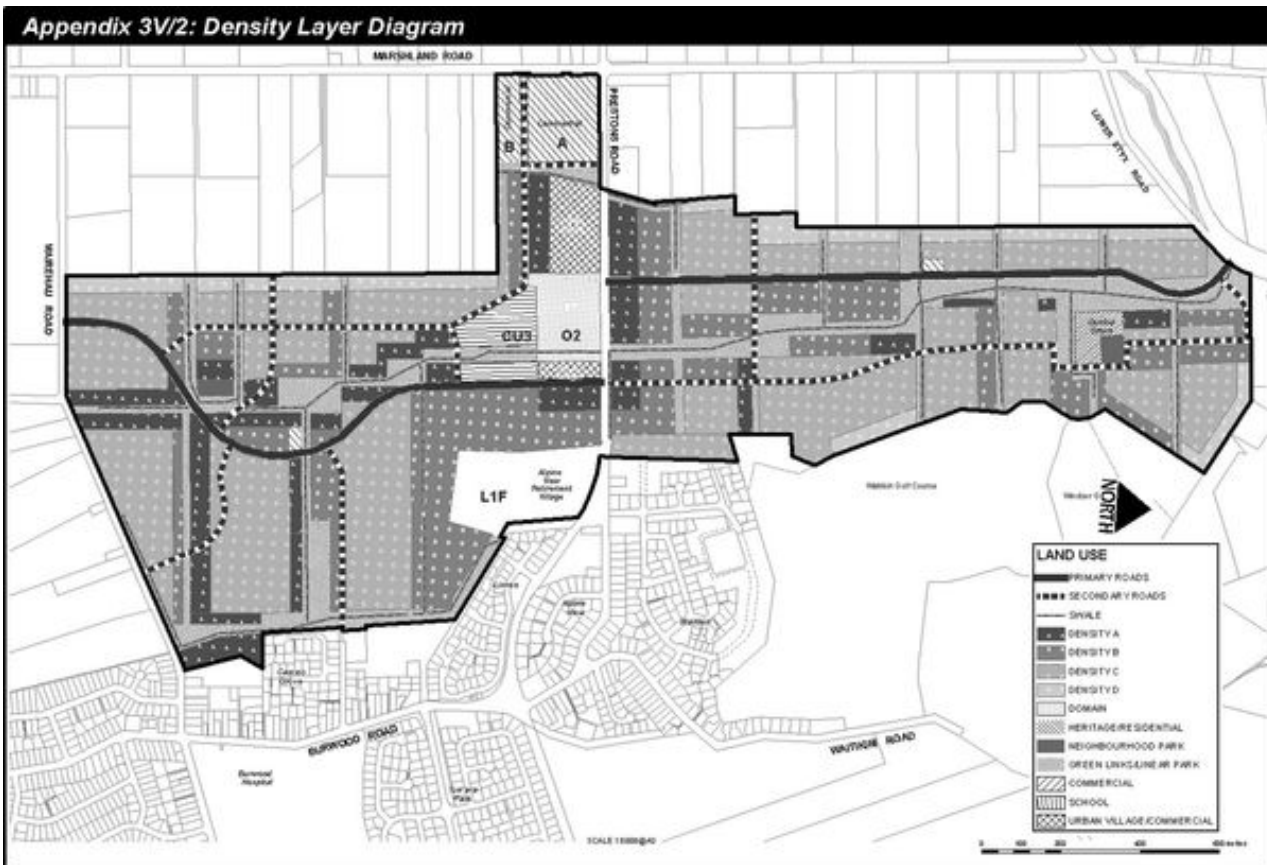

Business & Information Services
Corporate Support
Christchurch City Council

Map : pc_3V-02.gws
Date : 11/2011

Appendix 3V/3(i) - Movement Network Layer Diagrams and Associated Key Principles (Prestons)

Updated 1 November 2011

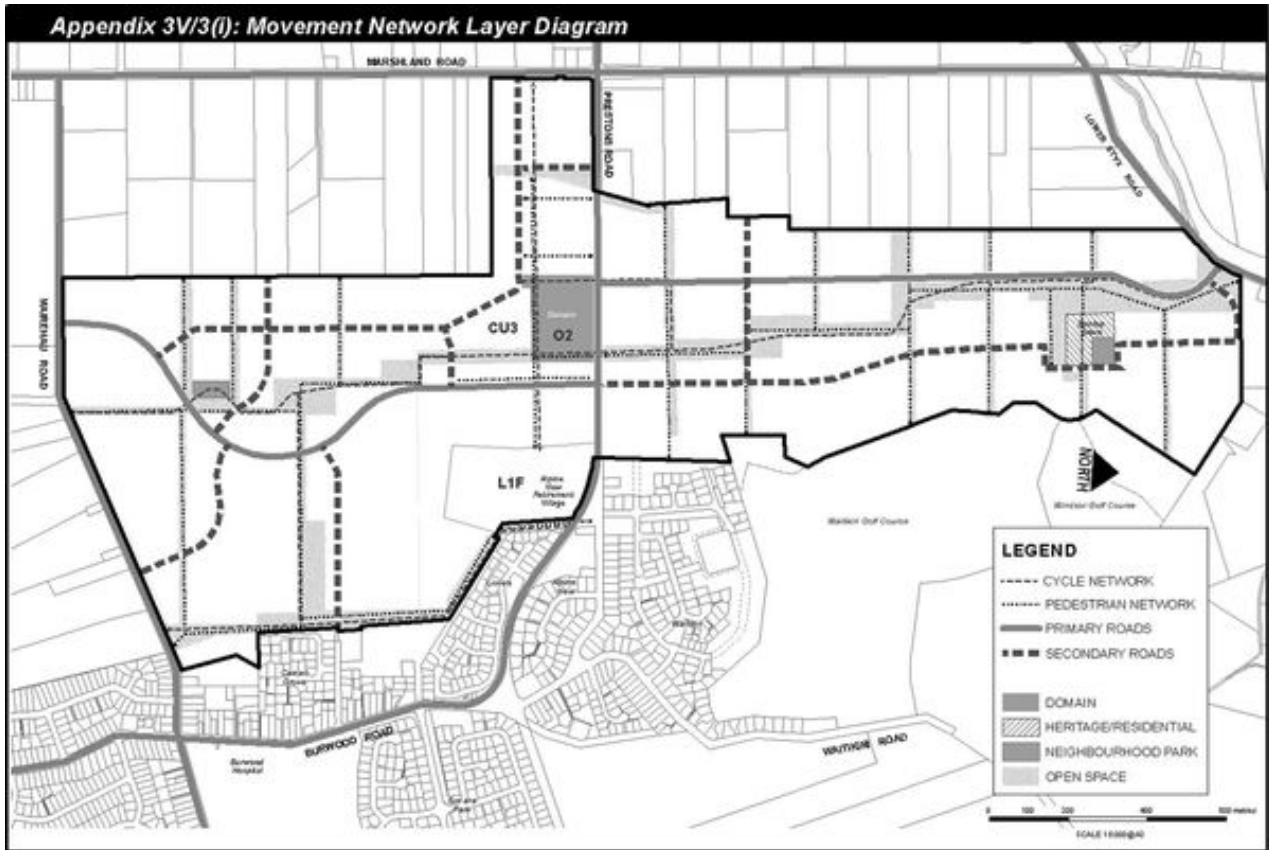

Appendix 3V/3(ii) - Movement Network Layer Diagrams - Cycle (Prestons)

Updated 1 November 2011

Appendix 3V/3(ii) - Movement Network Layer Diagrams - Cycle (Prestons)

Appendix 3V/3(ii): Movement Network Layer Diagram - Cycle Network

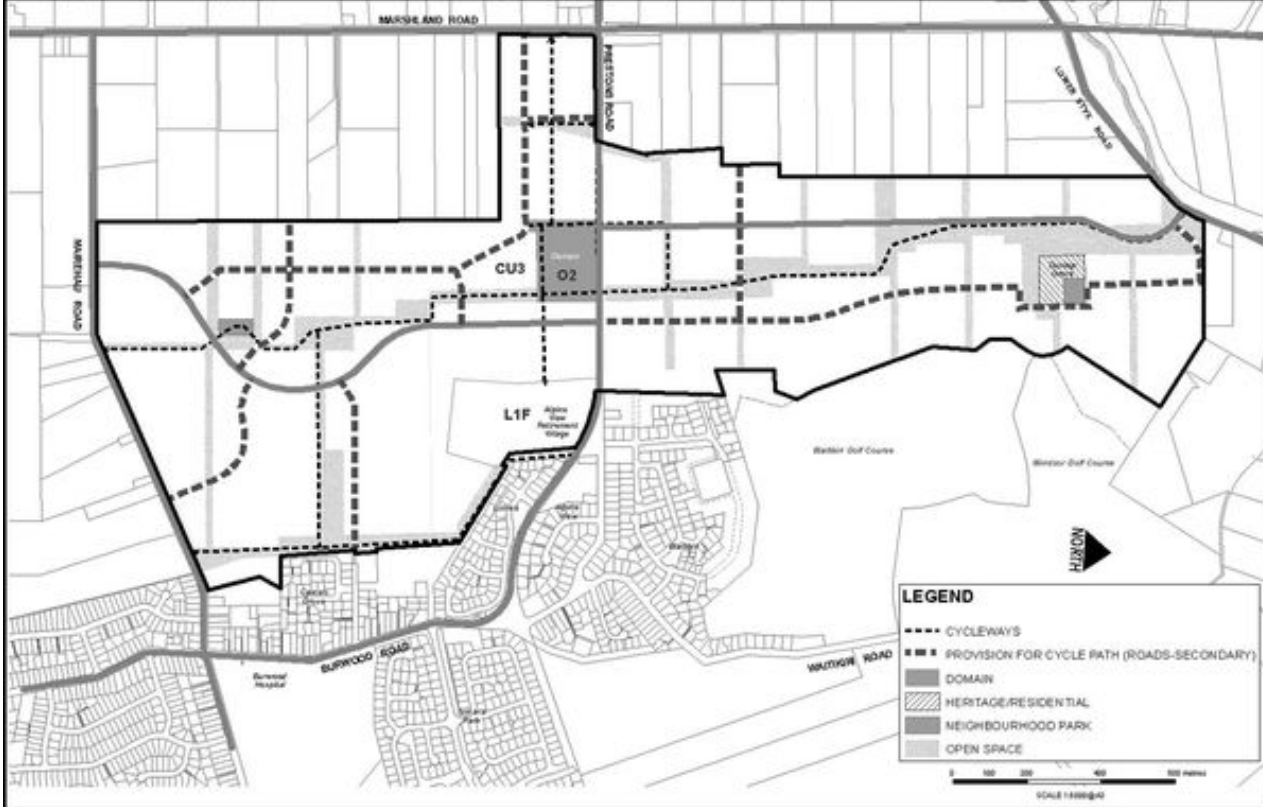

Business & Information Services
Corporate Support
Blackburn City Council

Map 1.ppt_20-06.ppt
Date: 09/10/2011

Appendix 3V/3(iii) - Movement Network Layer Diagrams - Pedestrian (Prestons)

Updated 1 November 2011

Appendix 3V/3(iii): Movement Network Layer Diagram - Pedestrian Network

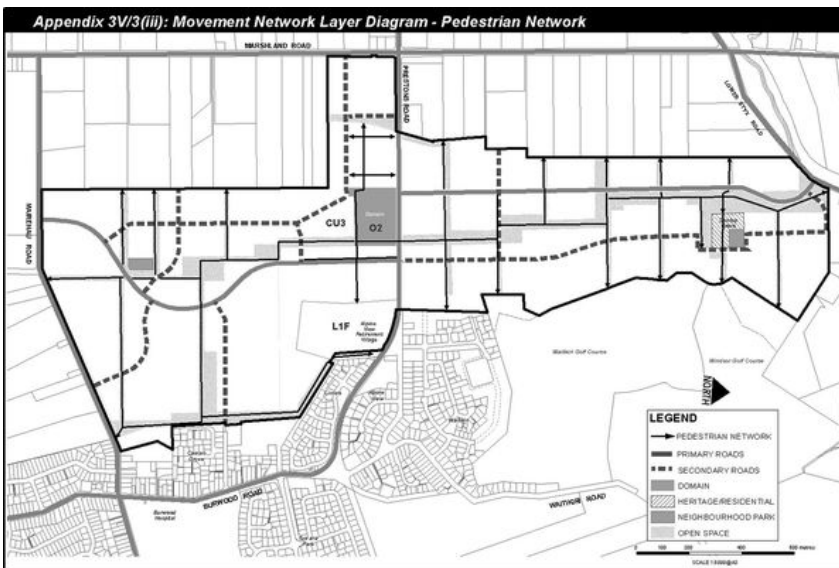

Business & Information Services
Corporate Support
Blackburn City Council

Map 1.ppt_20-06.ppt
Date: 09/10/2011

Appendix 3V/3 (iv) - Master Plan Road (Prestons)

Updated 1 November 2011

Appendix 3V/3 (iv) - Master Road Plan

COLLECTOR ROAD (PRIMARY MASTERPLAN ROAD)

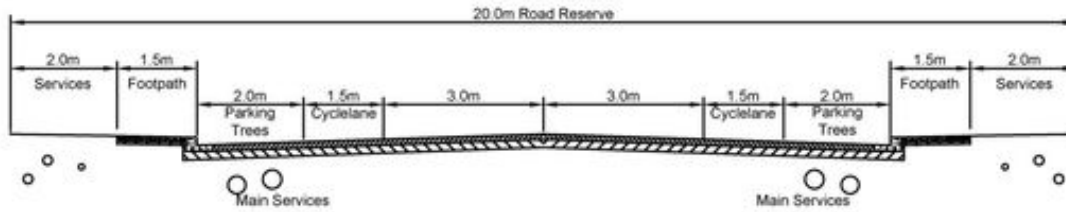

LOCAL ROAD (SECONDARY MASTERPLAN ROAD)

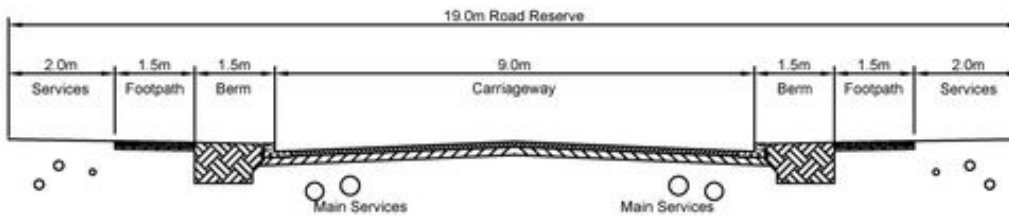

LOCAL ROAD (SECONDARY MASTERPLAN ROAD, FUTURE PROOF OPTION)

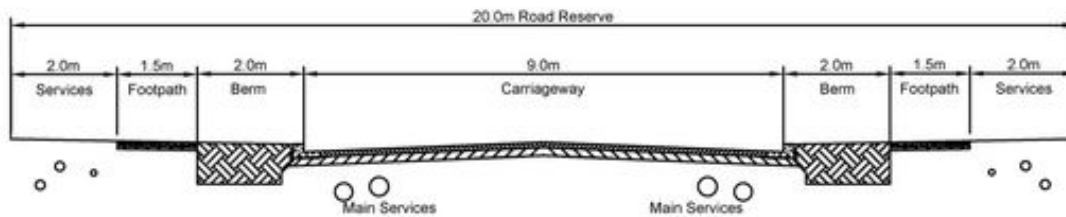

LOCAL ROAD (TERTIARY MASTERPLAN ROAD)

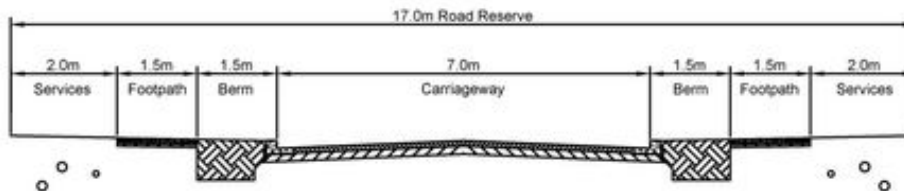

NEIGHBOURHOOD ROAD (TERTIARY MASTERPLAN ROAD)

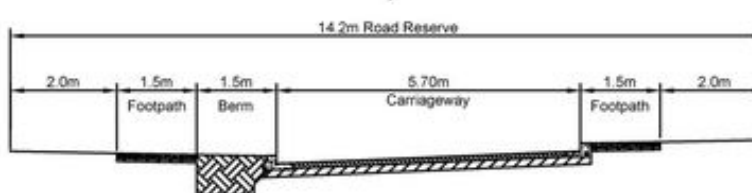

- * 'Future Proof Option' shall apply to the two east-west secondary roads that connect the north-south primary roads with the western boundary of the Living G (Prestons) zone, as shown on the Movement Network Layer Diagram. This typology includes a wider berm than the standard secondary road to allow for potential widening of the carriageway in the even such works are required to accommodate future increases in traffic flows.

Appendix 3V/4 - Blue Network Layer Diagram (Prestons)

Appendix 3V/4: Movement Network Layer Diagram - Blue Network

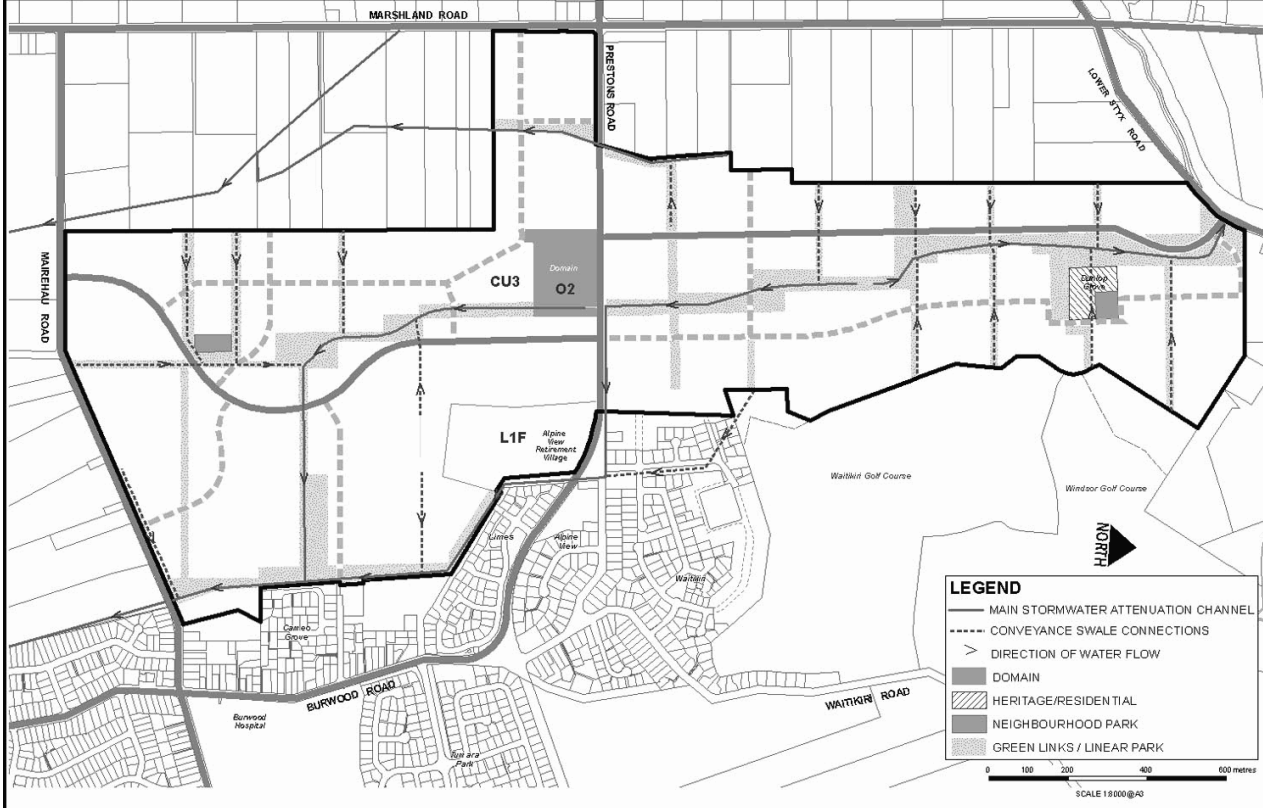

Business & Information Services
Corporate Support
Christchurch City Council

Map : pc_39-06.gvs
Date : 05/12/2011

Appendix 3V/5 - Green Network Layer Diagram (Prestons)

Updated 1 November 2011

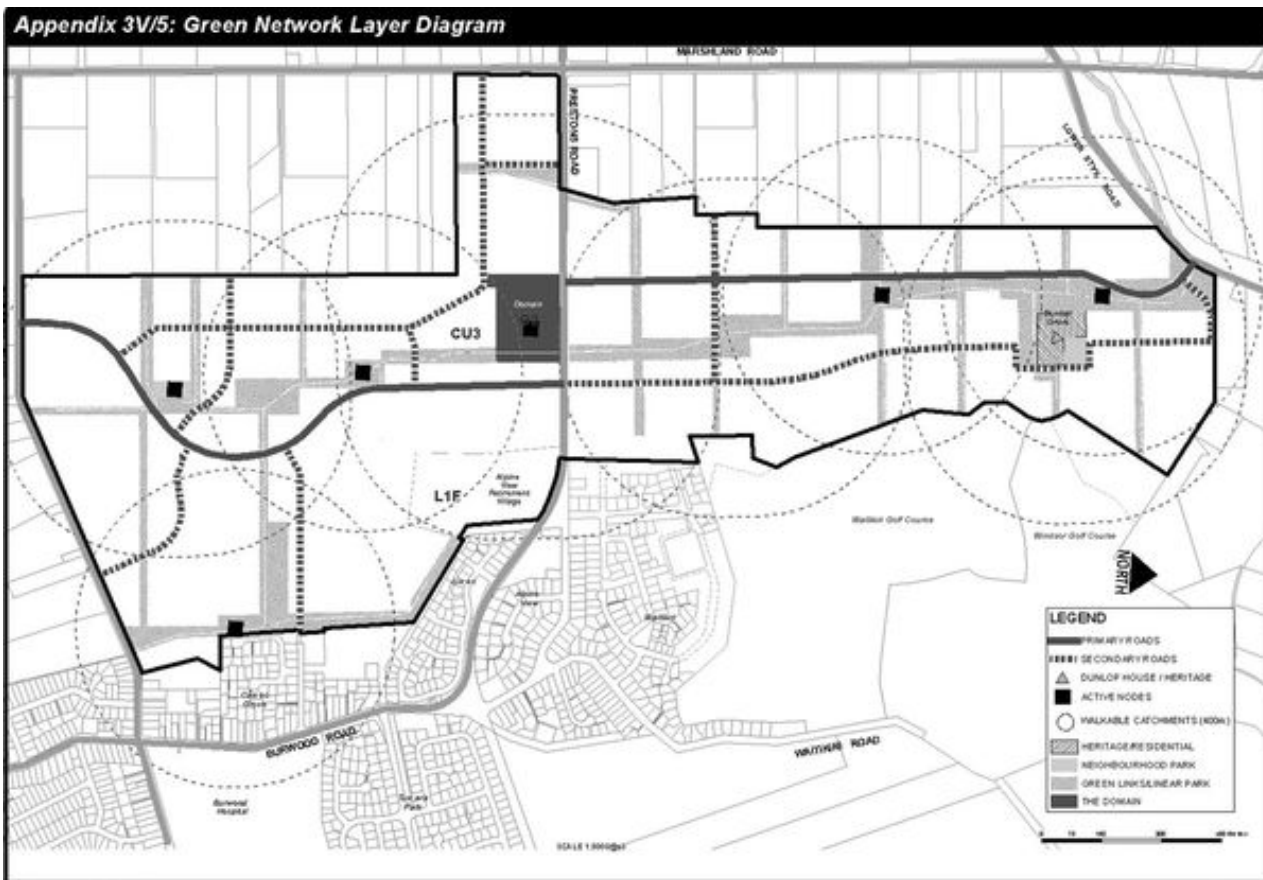

Business & Information Services
Corporate Support
Christchurch City Council

Map : pc_39-02.gvs
Date : 09/10/2011

Appendix 3V/6 - Living G (Prestons) Planting List (Prestons)

Large Native Trees	
Dacrydium cupressinum	rimu
Podocarpus totara	totara
Prumnopitys taxifolia	matain
Large Exotic Trees	
Acer campestre	field maple
Alnus Glutinosa	black alder
Liquidambar styraciflua	liquidambar
Platanus orientali	"autumn glory" plane tree
Quercus coccinea	scarlet oak
Quercus palustris	pin oak
Tilia cordata	small-leaved lime
Small Native Trees	
Dodonea viscosa	akeake
Kunzea ericoides	kanuka
Leptospermum scoparium m	manuka
Plagianthus regius manatu	lowland ribbonwood
Sophora microphylla	south island kowhai
Native Shrubs and Small Trees >1.2m	
Coprosma propinqua	mikimiki
Coprosma robusta	karama
Coprosma aff.	mikimiki (shrub)
Cordyline australis ti kouka	kouka/cabbage tree
Griselinia littoralis	kapuka/broadleaf
Hebe salicifolia	koromiko (shrub)
Hoheria angustifolia	hohera/narrow-leaved lacebark
Lophomyrtus obcordata	rohutu/nz murtle
Melicope simplex	poataniwha (shrub)
Melicytus ramiflorus	mahoe
Myrsine divaricata	weeping mahout
Olearia paniculata	golden akeake/akiraho
Pennantia corymbosa	kaikomako
Phomium tenax	harakeke
Pittosporum tenuifolium	kohuhu/black matipo/tawhiro
Pseudopanax crassifolius	horoeka/lancewood

Native Shrubs <1.2m	
Anemanthele lessoniana	hunangamoho/wind grass
Astelia frangrans	kakaha/bush lily
Carex buchananii	purei
Carex testacea speckled sedge	speckled sedge
Cyperus ustulatus	toetoe upotangata
Dainella nigra	inkberry
Festuca novae-zelandiae	fescue tussock
Haloragis erecta	toatoa
Hypericum gramineum	new zealand st johnswort
Libertia ixioides	mikoiko/nz iris
Poa cita	silver tussock
Poa colensoi	blue tussock
Polystichum richardii	pikopiko/black shield fern
Ucinia uncinata	hook-sedge

Appendix 3V/7(i) - Living G (Prestons) Intersection Upgrades - Figure. 1

Updated 1 November 2011

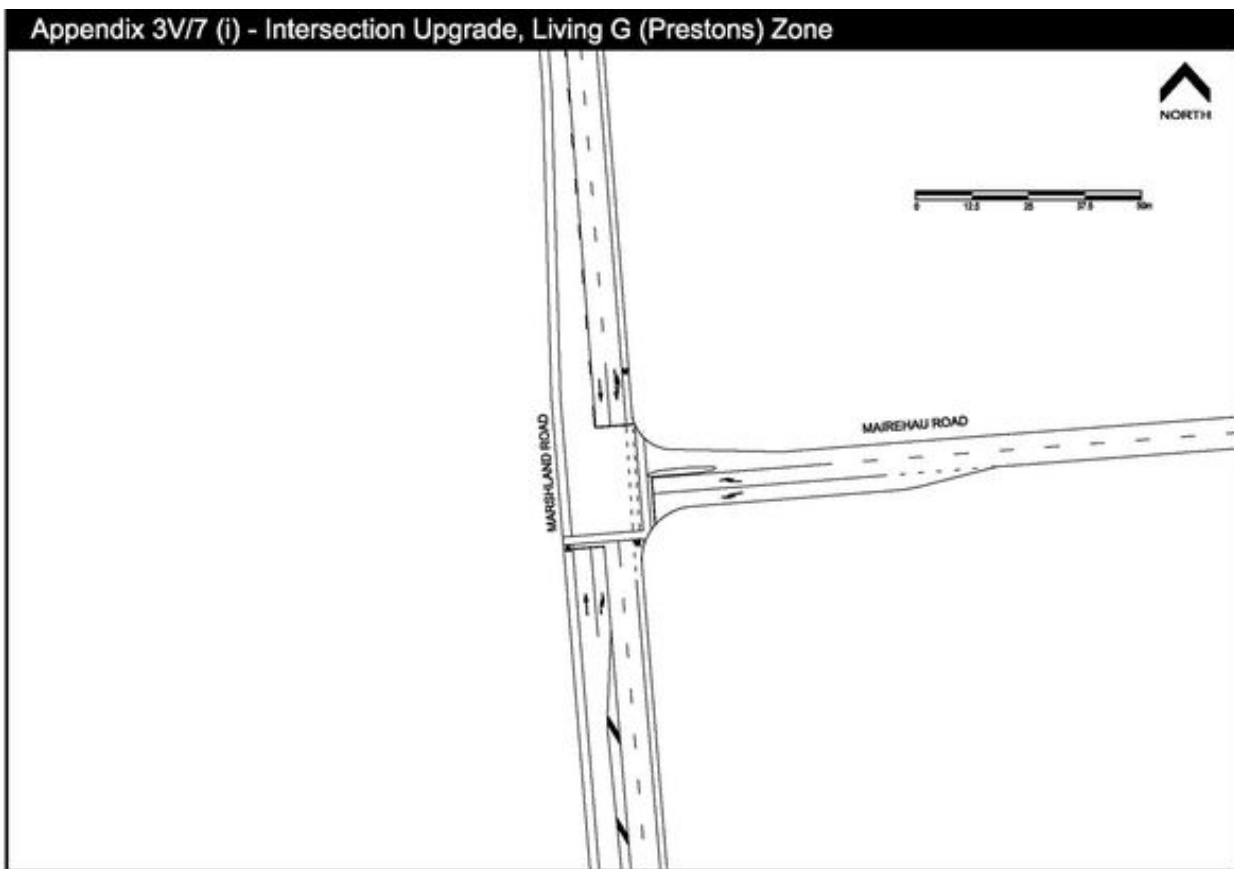

Business & Information Services
Corporate Support
Christchurch City Council

Map 1
Date: 16/12/2011

Appendix 3V/7(ii) - Living G (Prestons) Intersection Upgrades - Figure. 2

Updated 1 November 2011

Appendix 3V/7(ii) - Living G (Prestons) Intersection Upgrades - Figure. 2

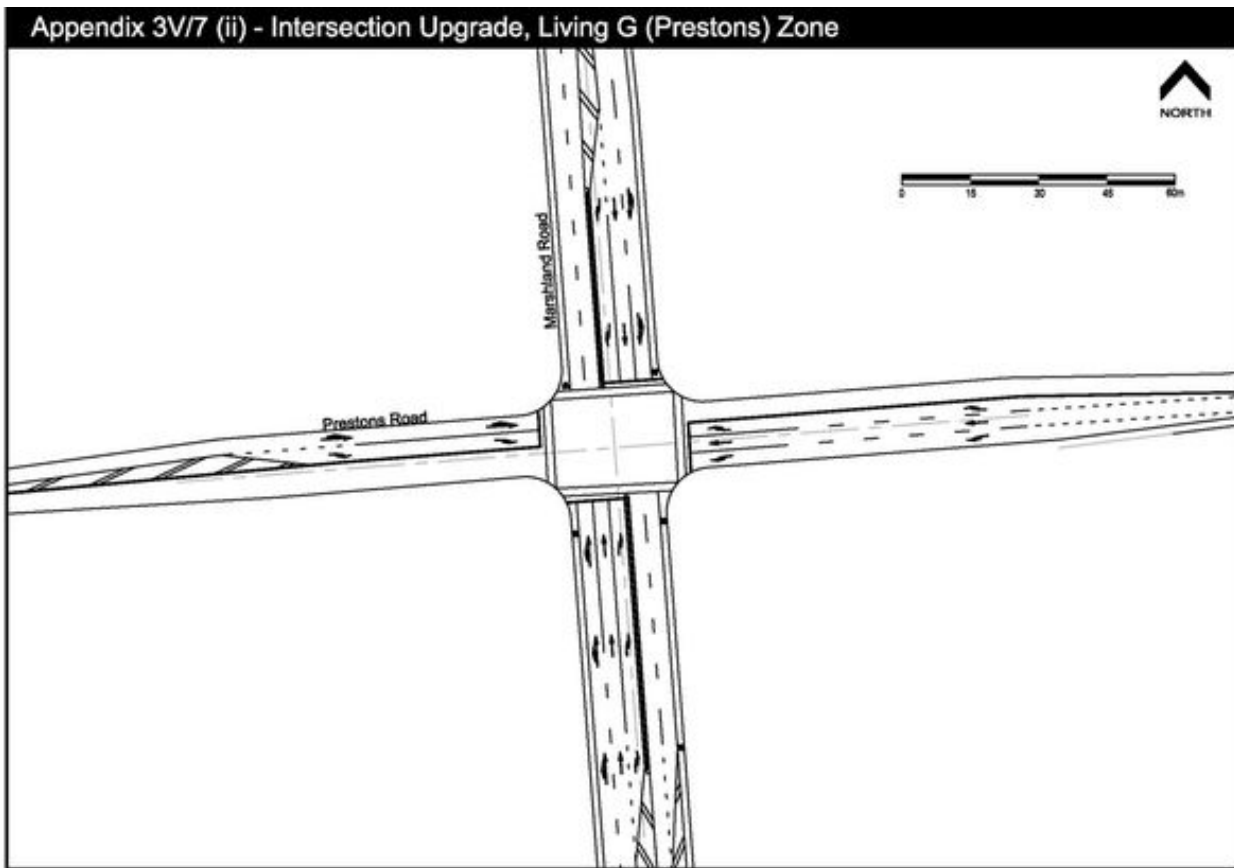

Business & Information Services
Corporate Support
Christchurch City Council

Map :
Date : 16/12/2011

Appendix 3V/7(iii) - Living G (Prestons) Intersection Upgrades - Figure. 3

Updated 1 November 2011

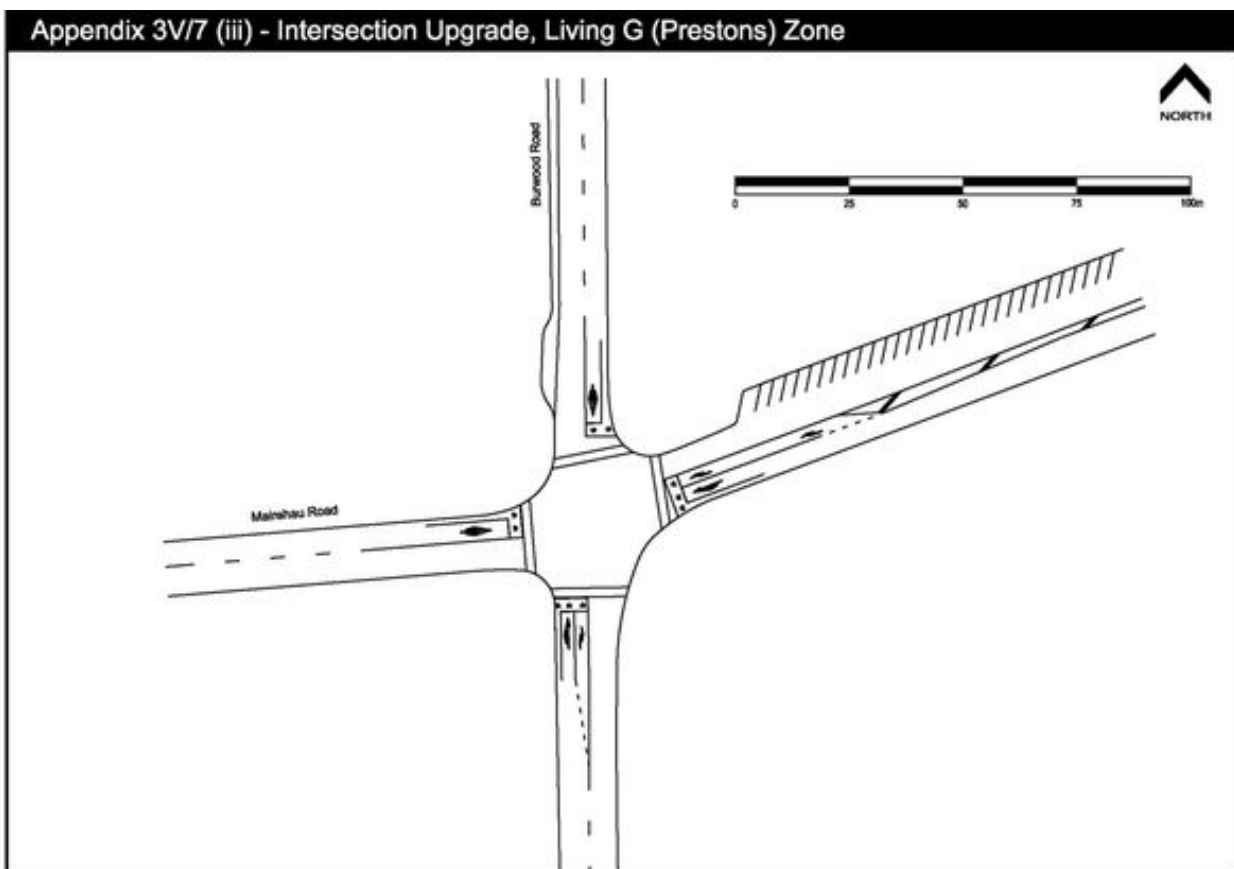

Business & Information Services
Corporate Support
Christchurch City Council

Map :
Date : 16/12/2011

Appendix 3V/7(iv) - Living G (Prestons) Intersection Upgrades - Figure. 4

Updated 1 November 2011

Appendix 3V/7 (iv) - Intersection Upgrade, Living G (Prestons) Zone

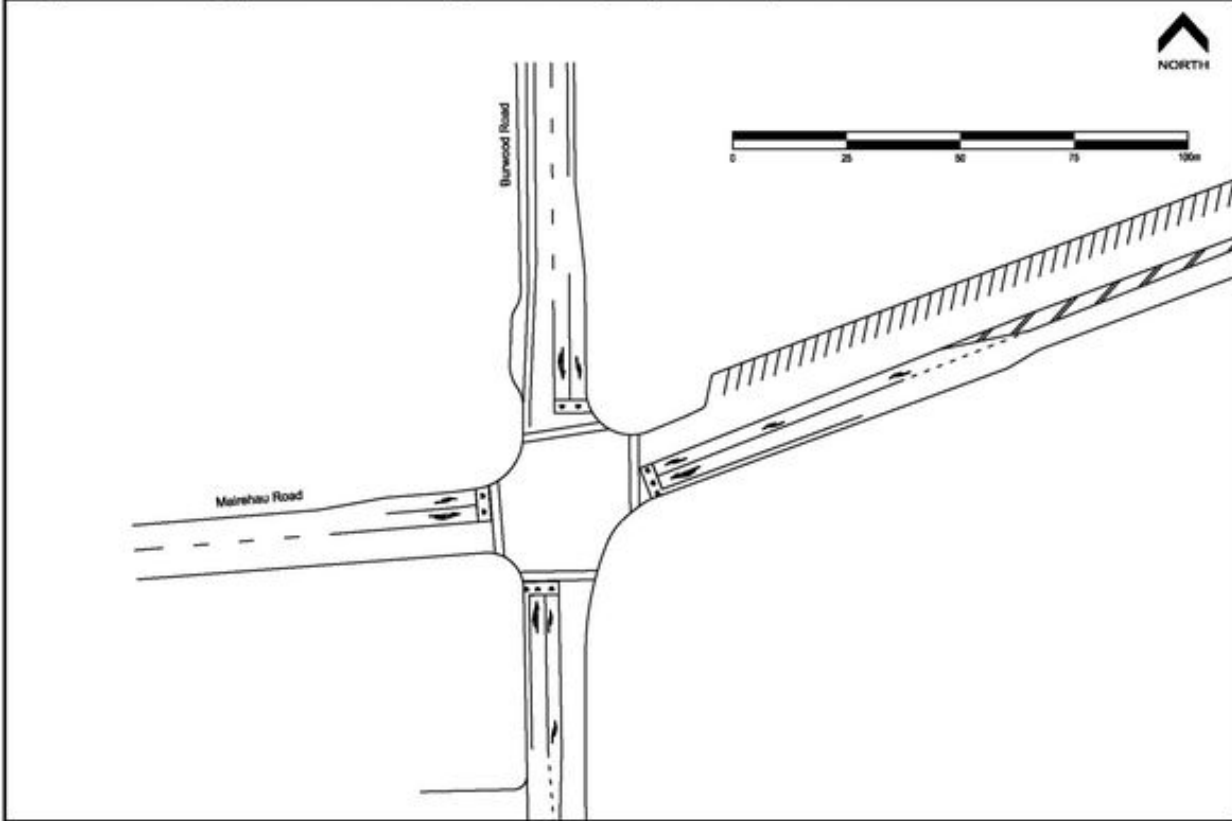

Business & Information Services
Corporate Support
Christchurch City Council

Rev :
Date : 16/12/2011

Appendix 3V/7(v) - Living G (Prestons) Intersection Upgrades - Figure. 5

Updated 1 November 2011

Appendix 3V/7 (v) - Intersection Upgrade, Living G (Prestons) Zone

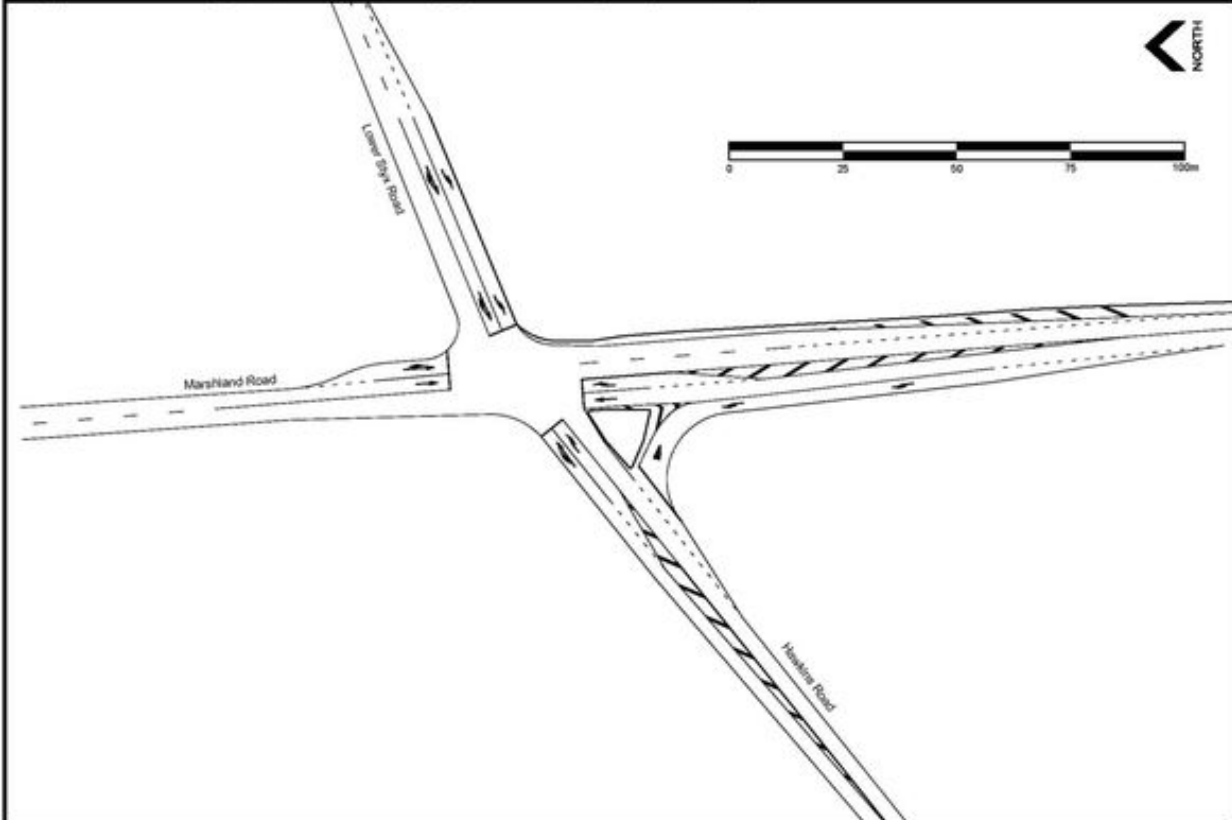

Business & Information Services
Corporate Support
Christchurch City Council

Rev :
Date : 16/12/2011

Appendix 3V/8 - Accidental Discovery Protocol

Updated 1 November 2011



ACCIDENTAL DISCOVERY PROTOCOLS (ADPs) for ARCHAEOLOGY

Under the *Historic Places Act 1993* (the Act) an archaeological site is defined as any place associated with pre-1900 human activity, where there is material evidence relating to the history of New Zealand. For sites solely of Maori origin, this evidence may be in the form of accumulations of shell, bone, charcoal, burnt stones, etc. In later sites, artefacts such as bottles or broken glass, ceramics, metal, etc. may be found or evidence of old foundations, wells, drains, tailings, races or other structures. Human remains / koiwi may date to any historic period.

It is unlawful for any person to destroy, damage or modify the whole or any part of an archaeological site without the prior authority of the New Zealand Historic Places Trust. This is the case regardless of the legal status of the land on which the site is located, whether the activity is permitted under the District or Regional Plan or whether a resource or building consent has been granted. The Act provides for substantial penalties for unauthorised damage or destruction.

A. Prior to commencement of any works, it is the responsibility of the developer (or land owner) to:

- provide to the Regional Archaeologist of the NZ Historic Places Trust (NZHPT) information clearly outlining the location and extent of works and contact details for the site manager;
- provide a copy of these ADPs and contact details for the Regional Archaeologist of the NZHPT to the site manager, who will ensure all contractors working on site are briefed about the appearance of archaeological remains and the protocols that apply should archaeological remains be located;
- inform the Regional Archaeologist of the NZHPT of the start date of any works. This is to ensure that if any archaeological material is located, decisions may be made in good time.

B. In the event of an 'accidental discovery' of archaeological remains, the following steps shall be taken:

1. All activity affecting the immediate area will cease and the Regional Archaeologist of the NZHPT will be notified without delay.
2. The site will be secured to ensure that archaeological remains are not further disturbed.
3. Works affecting archaeological remains will not recommence until either:
 - a. the Regional Archaeologist of the NZHPT has confirmed in writing that the archaeological provisions of the *Historic Places Act 1993* do not apply;
 - b. or the requirements of the archaeological provisions of the *Historic Places Act 1993* have been met and, if required, an archaeological authority has been granted by the NZHPT.
4. If human remains / koiwi are located, in addition to steps 1 to 3 above, the Runanga representative for the area and the New Zealand Police must be contacted.

C. Once works are completed, if no archaeological remains have been located, the developer / land owner should confirm this in writing to the Regional Archaeologist of the NZHPT.

Contact details for the NZHPT Southern Regional Office archaeologist (Canterbury / West Coast):

Email: archaeologistcw@historic.org.nz Phone: 03 365 2897 or 365 0805 Fax: 03 374 2433

New Zealand Historic Places Trust / Pouhere Taonga
Gough House, 90 Hereford Street / PO Box 4403, Christchurch 8140
www.historic.org.nz

Appendix 3W - Outline Development Plan (Halswell West)

Appendix 3W - Outline Development Plan

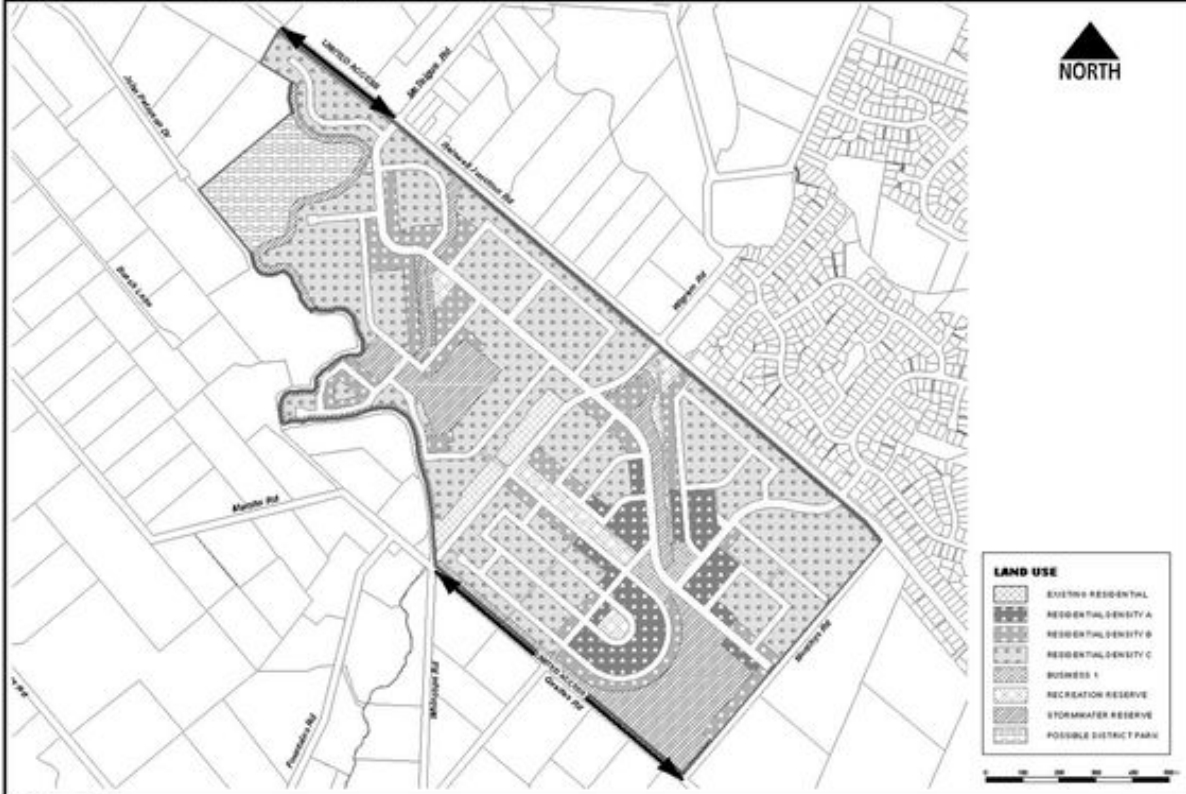

Business & Information Services
Corporate Support
Electrical & IT Services

Appendix 3W/a - Marker Buildings and Focal Points (Halswell West)

Updated 1 November 2011

Appendix 3W(a) - Marker Buildings & Focal Points

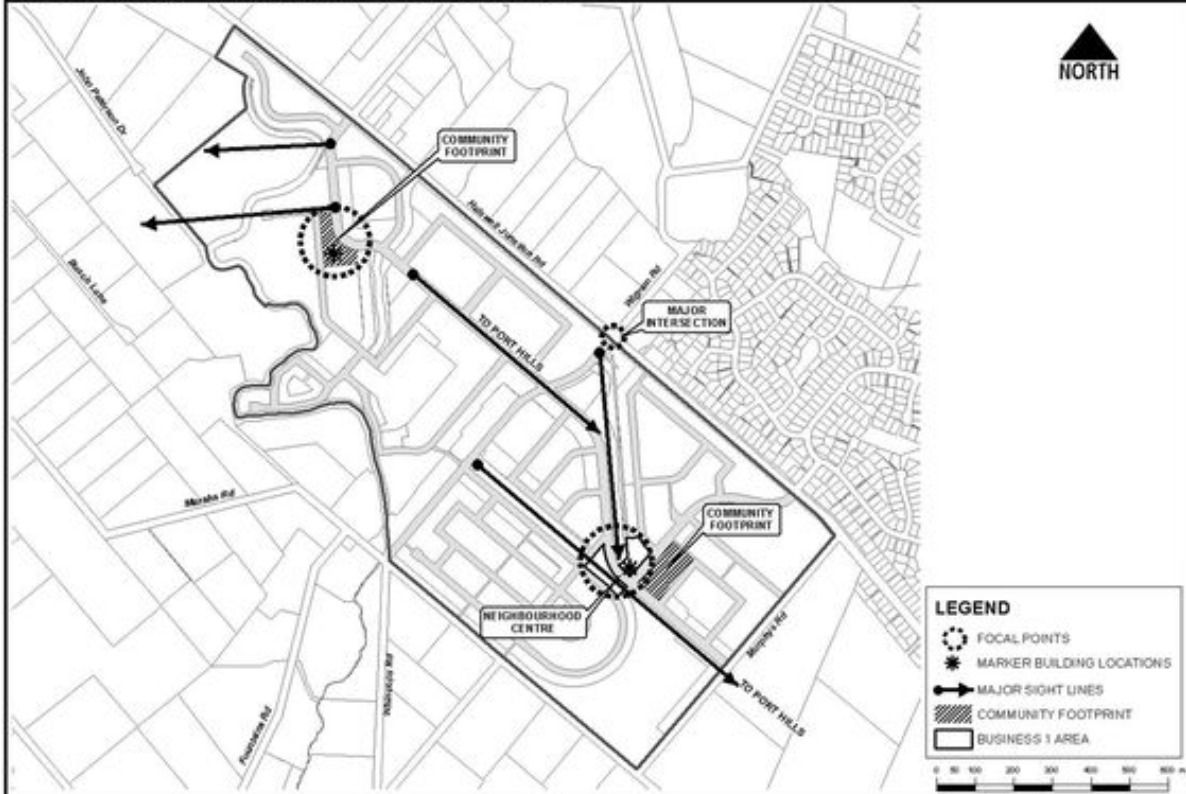

Business & Information Services
Corporate Support
Electrical & IT Services

Appendix 3W/b - Movement Network (Halswell West)

Appendix 3W/b - Movement Network (Halswell West)

Updated 1 November 2011

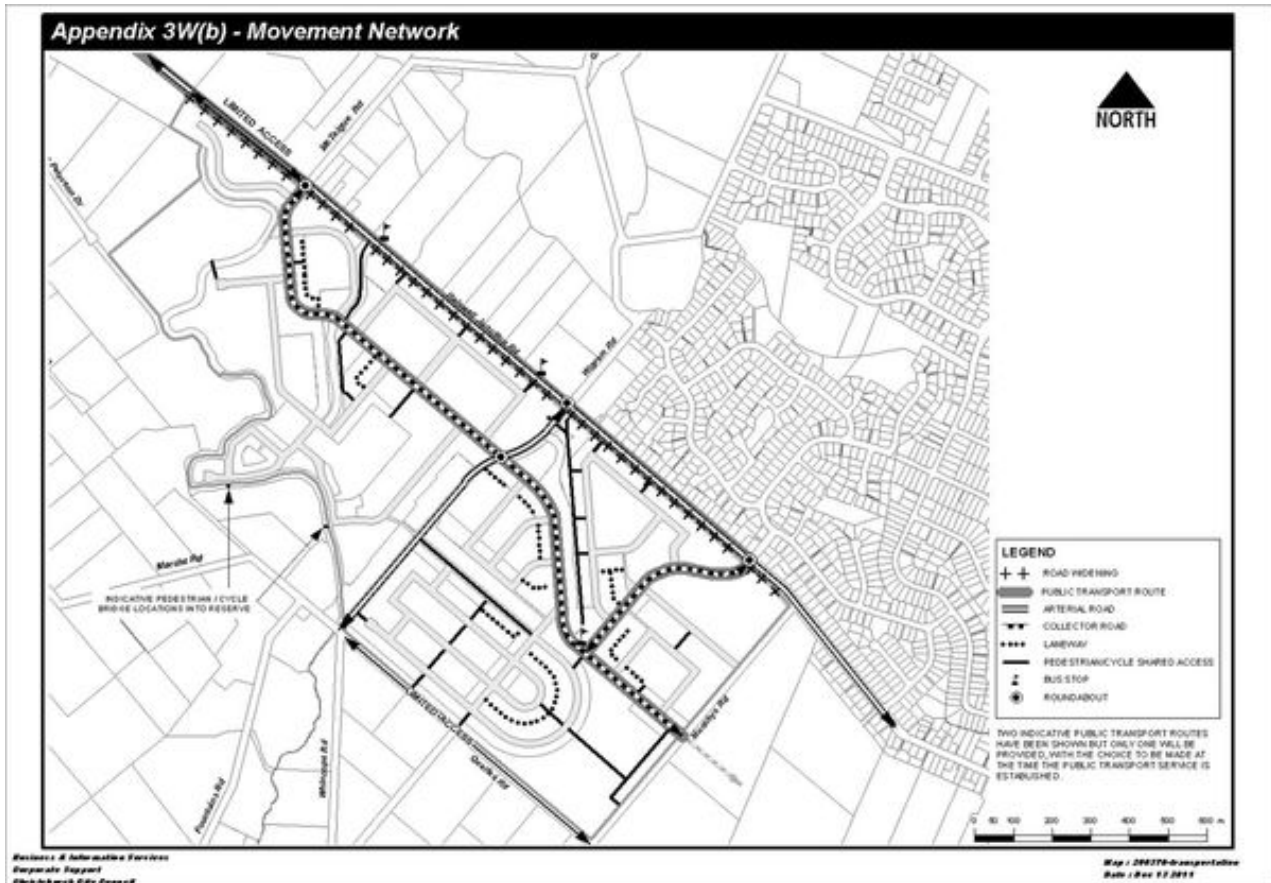

Appendix 3W/c - Blue Network (Halswell West)

Updated 1 November 2011

Appendix 3W(c) - Blue Network

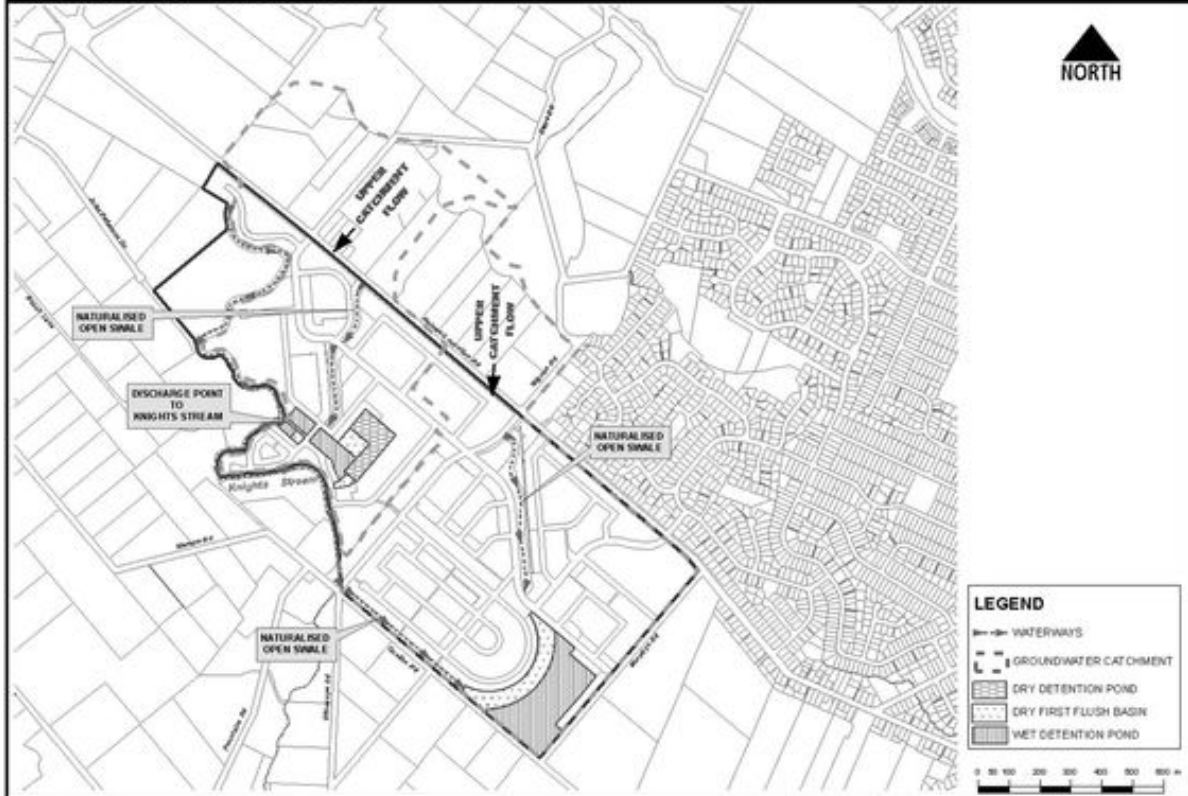

Business & Information Services
 Strategic Support
 Elizabeth City Council

Map : 20070-BLUE #1
 Date : Nov 12 2011

Appendix 3W/d - Green Network (Halswell West)

Updated 1 November 2011

Appendix 3W(d) - Green Network

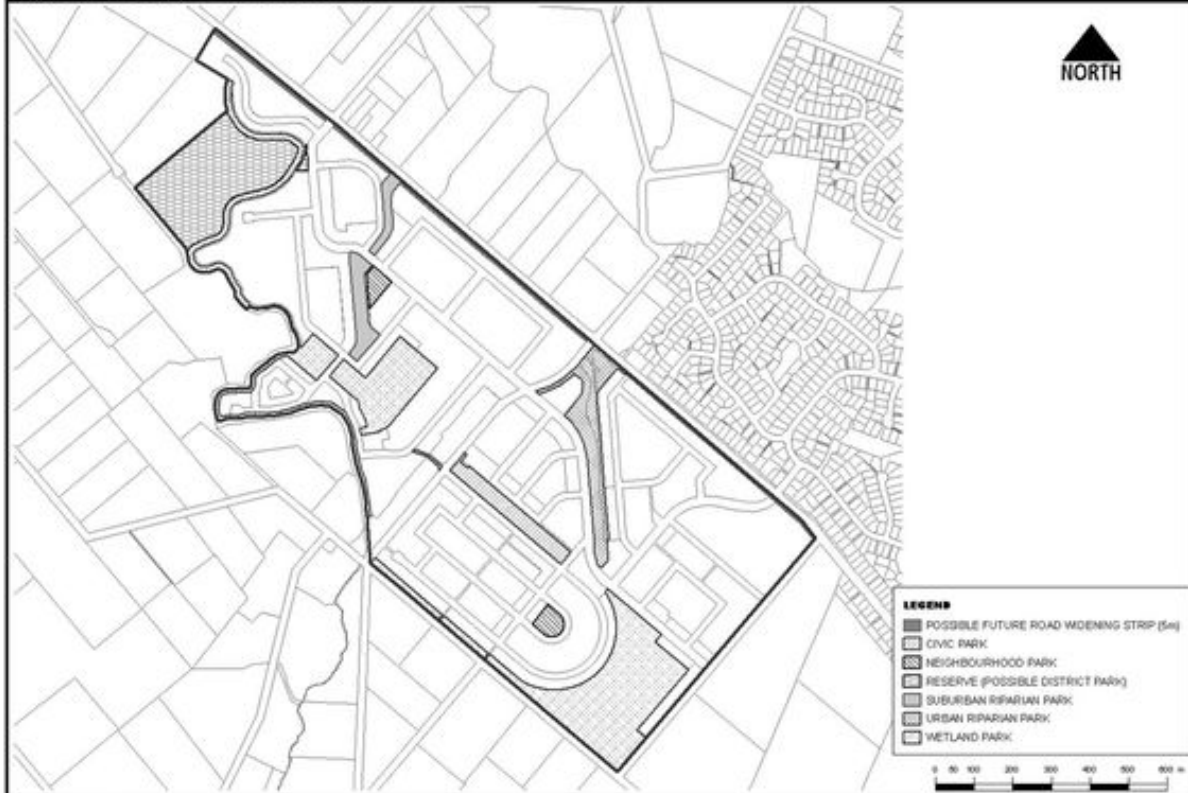

Business & Information Services
 Strategic Support
 Elizabeth City Council

Map : 20070-GREEN #4
 Date : Nov 12 2011

Appendix 3W/e - Reticulation Network (Halswell West)

Updated 1 November 2011

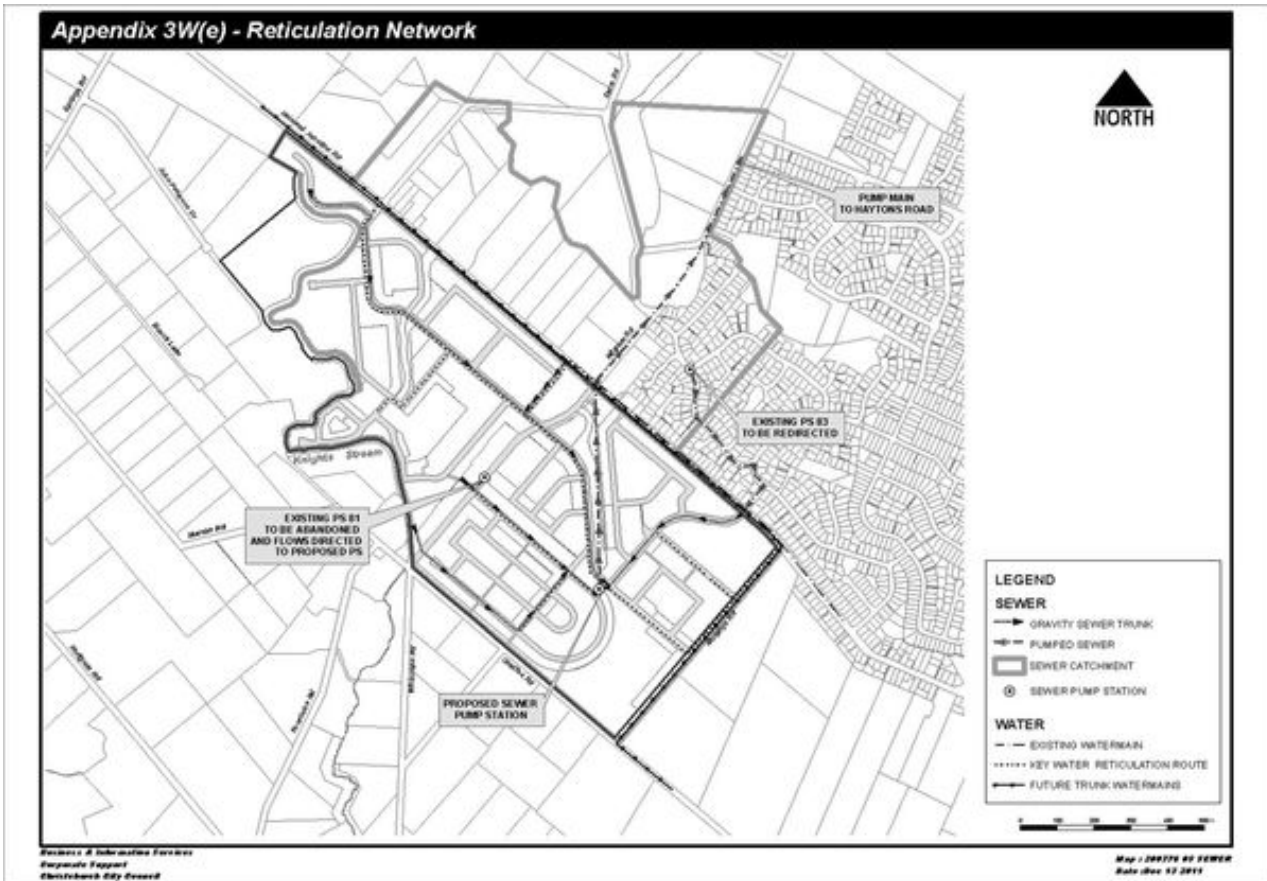

Appendix 3W/f - Tangata Whenua Layer Diagram (Halswell West)

Updated 1 November 2011

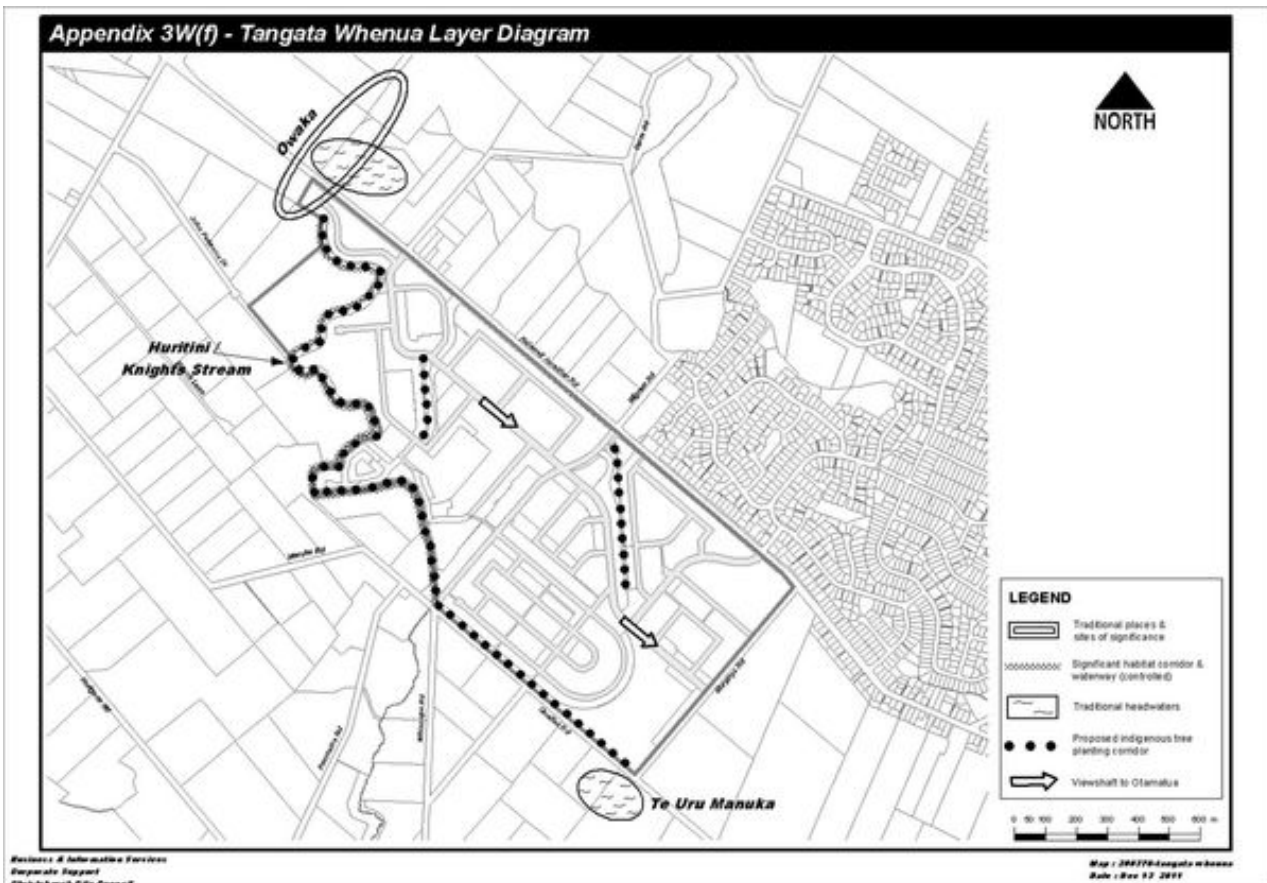

Appendix 3X(a) - Densities and Key Infrastructure (North West Belfast)

Updated 14 May 2012

APPENDIX 3X/1(a) - Outline Development Plan - Living G (North West Belfast) Zone - Densities & Key Infrastructure

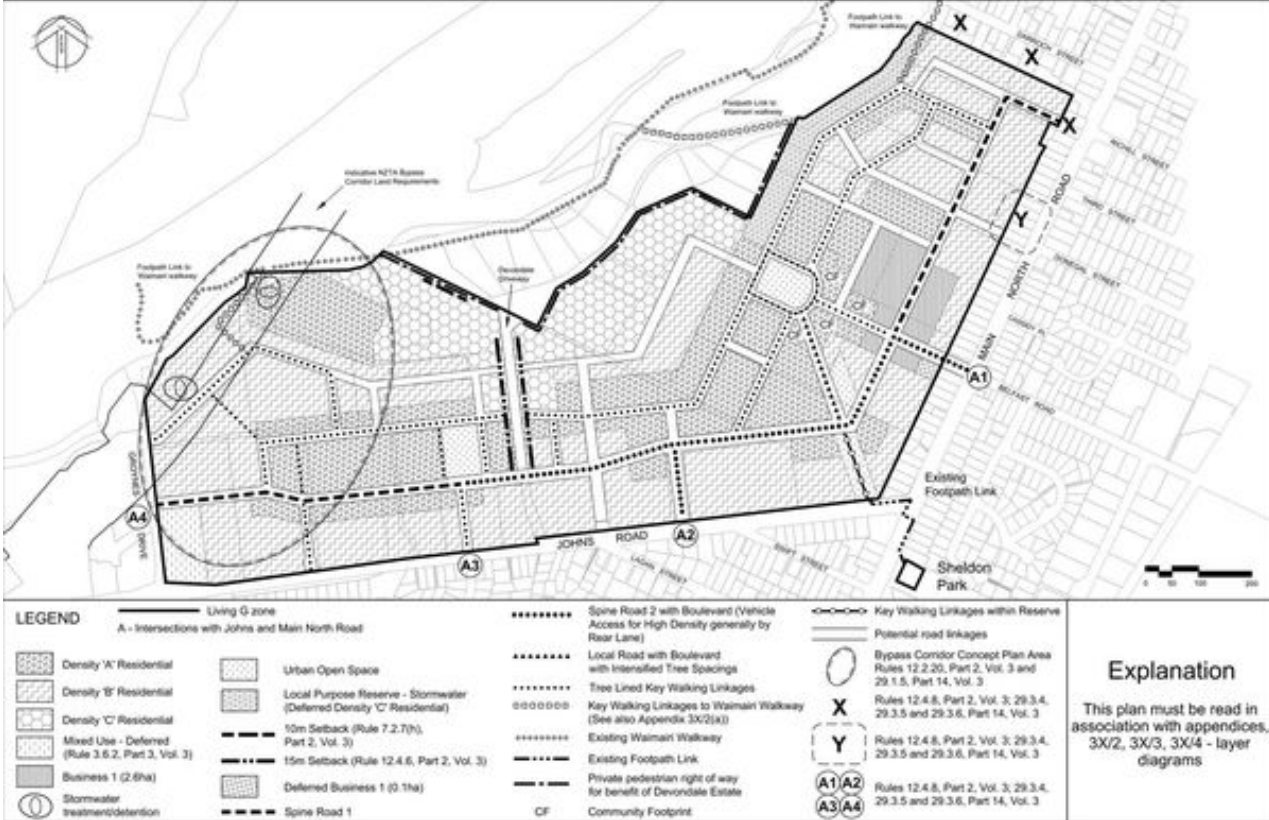

Appendix 3X(b) - Living G (North West Belfast) Zone

Updated 14 May 2012

APPENDIX 3X/1(b) - Living G (North West Belfast) Zone - Area 4



Appendix 3X2(a) - Green Network Layer Diagram (North West Belfast)

Updated 14 May 2012

APPENDIX 3X2(a) - Living G (North West Belfast) Zone - Green Network Layer Diagram

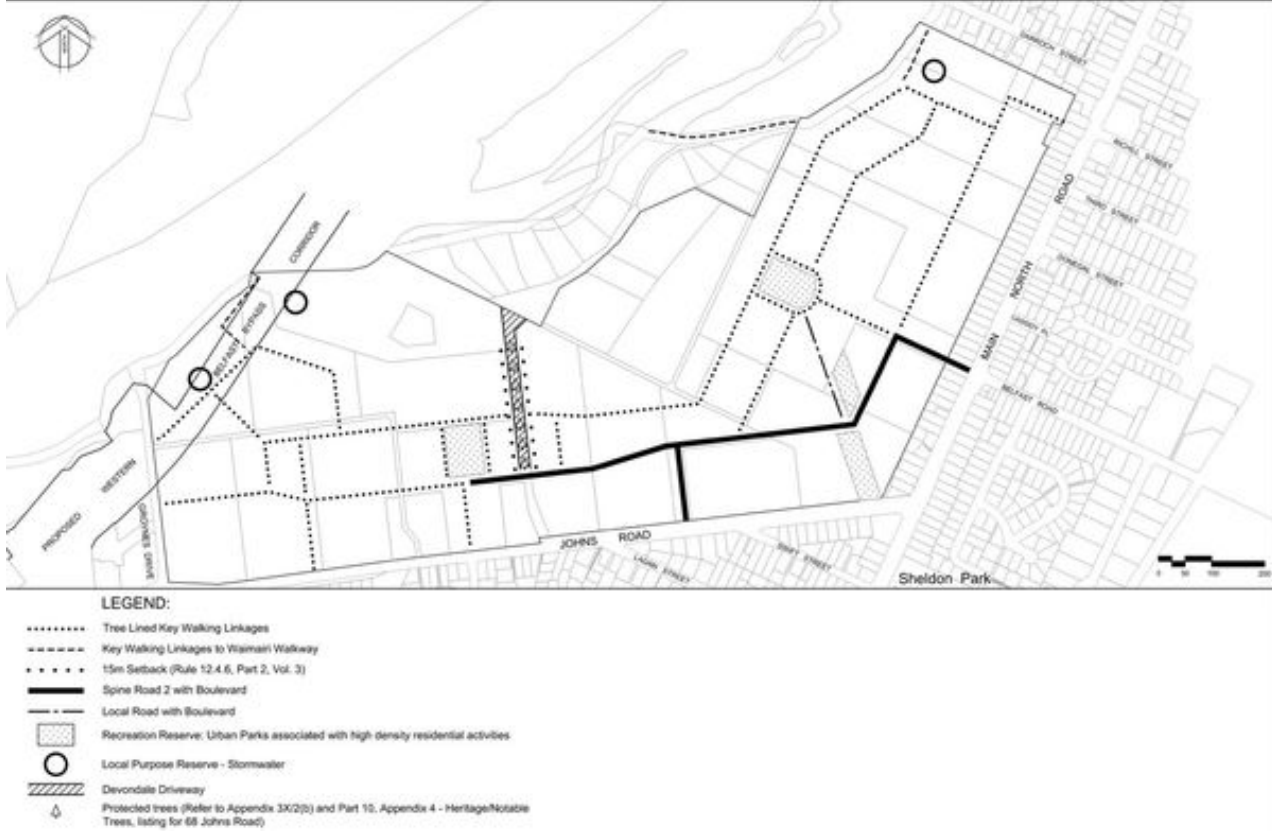

Appendix 3X2(b) - Protected Trees (North West Belfast)

Updated 14 May 2012

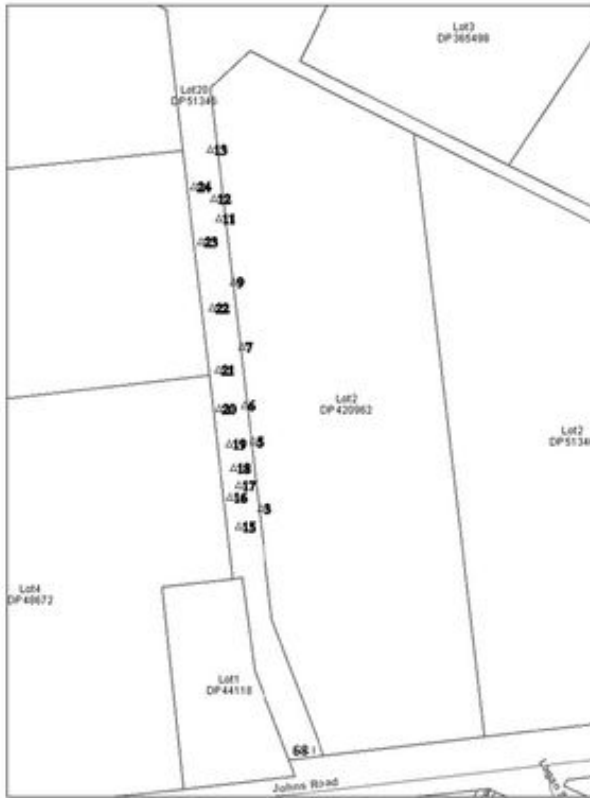

Devondale Estate Driveway (68 Johns Road)				
Trees to be Protected				
Botanical name	Common name	Tree No.	Parcel's legal description	Level of protection
Eastern Side (South to the Northern end security gates)				
<i>Acer pseudoplatanus</i>	Purple Sycamore	3	Lot 2 DP 420962	Subdivision
<i>Aesculus indica</i>	Indian Horse Chestnut	5	Lot 2 DP 420962	Subdivision
<i>Gleditsia triacanthos inermis</i> 'Skyline'	Honey Locust	6	Pt Lot 20 DP 51346	Subdivision
<i>Fagus sylvatica Purpurea</i>	Copper Beech	7	Lot 2 DP 420962	Subdivision
<i>Fagus sylvatica Purpurea</i>	Copper Beech	9	Pt Lot 20 DP 51346, Lot 2 DP 420962	Subdivision
<i>Fagus sylvatica Purpurea</i>	Copper Beech	11	Pt Lot 20 DP 51346	Subdivision
<i>Fagus sylvatica Purpurea</i>	Copper Beech	12	Pt Lot 20 DP 51346	Subdivision
<i>Fagus sylvatica Purpurea</i>	Copper Beech	13	Pt Lot 20 DP 51346	Listed Notable Tree
Western Side (South to the Northern end security gates)				
<i>Aesculus indica</i>	Indian Horse Chestnut	15	Pt Lot 20 DP 51346	Subdivision
<i>Castanea sativa</i>	Sweet Chestnut	16	Pt Lot 20 DP 51346	Subdivision
<i>Castanea sativa</i>	Sweet Chestnut	17	Pt Lot 20 DP 51346	Subdivision
<i>Quercus palustris</i>	Pin Oak	18	Pt Lot 20 DP 51346	Subdivision
<i>Quercus palustris</i>	Pin Oak	19	Pt Lot 20 DP 51346	Subdivision
<i>Aesculus indica</i>	Indian Horse Chestnut	20	Pt Lot 20 DP 51346	Subdivision
<i>Quercus palustris</i>	Pin Oak	21	Pt Lot 20 DP 51346	Subdivision
<i>Taxodium distichum</i>	Swamp Cypress	22	Pt Lot 20 DP 51346	Subdivision
<i>Aesculus indica</i>	Indian Horse Chestnut	23	Pt Lot 20 DP 51346	Subdivision
<i>Fagus sylvatica Purpurea</i>	Copper Beech	24	Pt Lot 20 DP 51346	Subdivision

Appendix 3X3 - Blue Network Layer Diagram (North West Belfast)

Updated 14 May 2012

APPENDIX 3X/3 - Living G (North West Belfast) Zone - Blue Network Layer Diagram

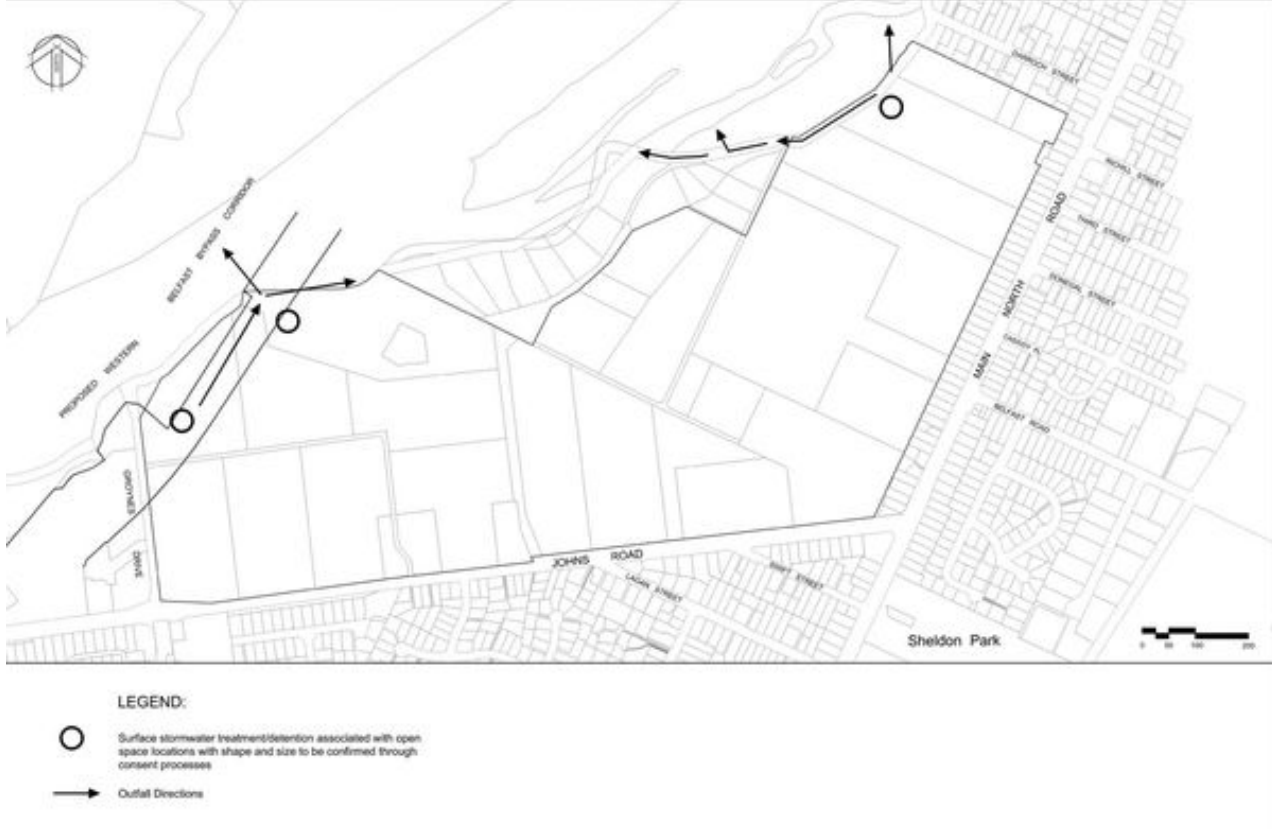

Appendix 3X4 - Movement Network Layer Diagram - Road Network - (North West Belfast)

APPENDIX 3X/4 - Living G (North West Belfast) Zone - Movement Network Layer Diagram (Road Network)

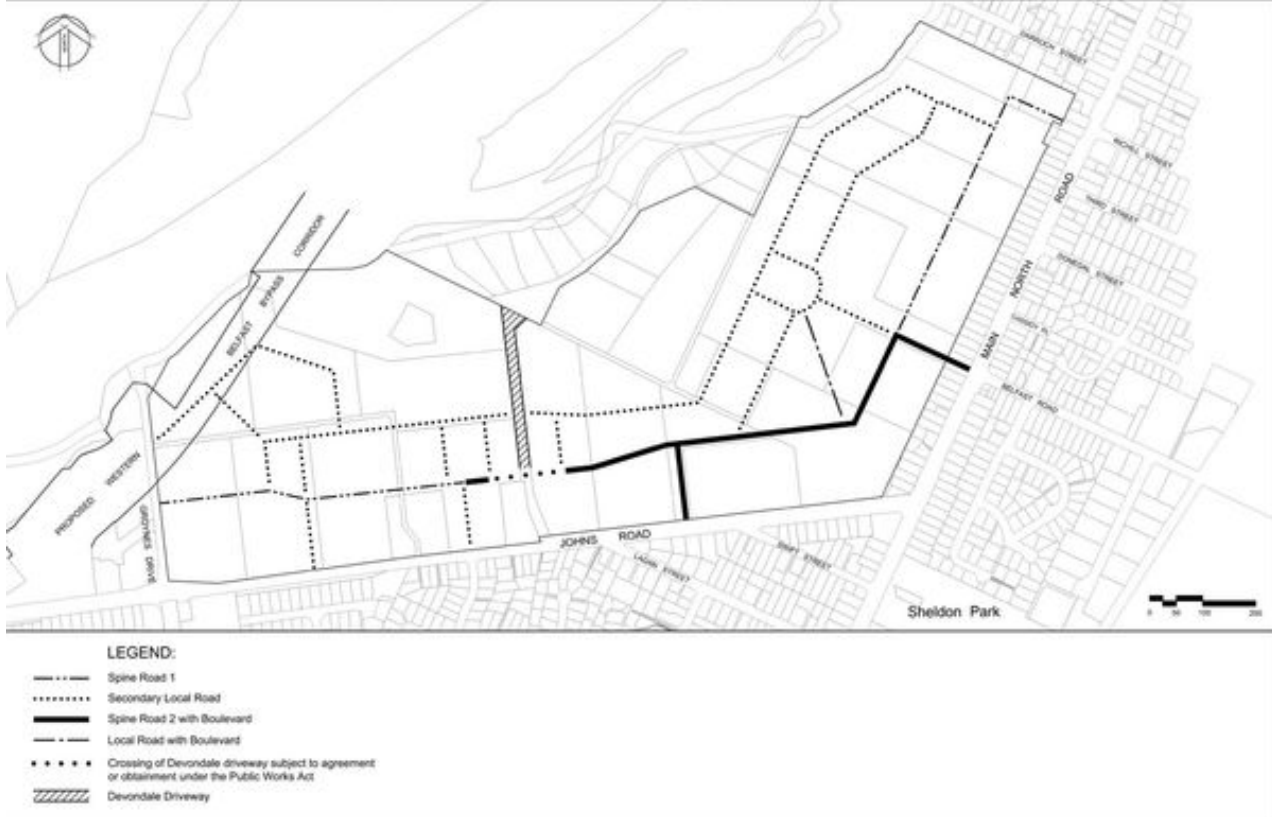

Appendix 3X4(a) - Movement Network Layer Diagram - Spine Road 2 with Boulevard (North West Belfast)

APPENDIX 3X/4(a) - Living G (North West Belfast) Zone - Movement Network Layer Diagram - Spine Road 2 with Boulevard

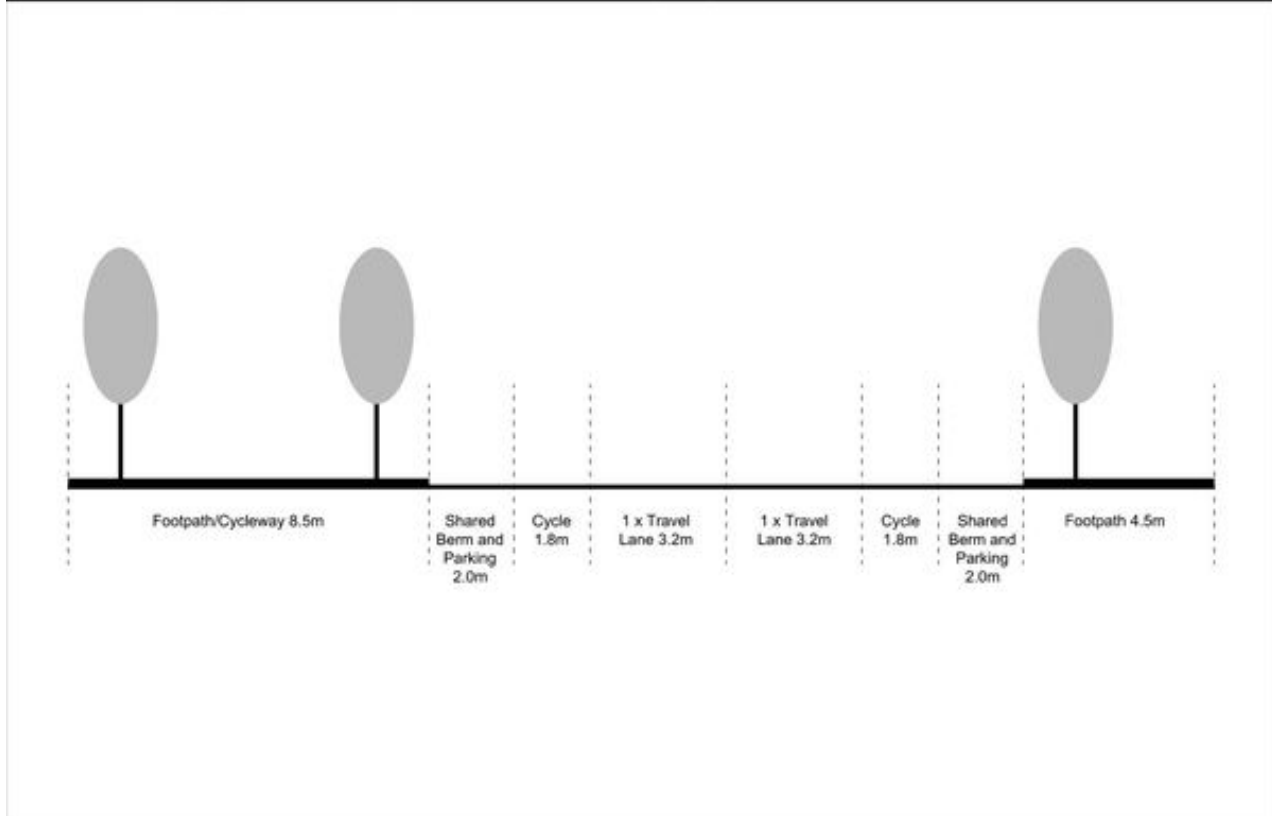

Appendix 3X4(b) - Movement Network Layer Diagram - Local Road with Boulevard (North West Belfast)

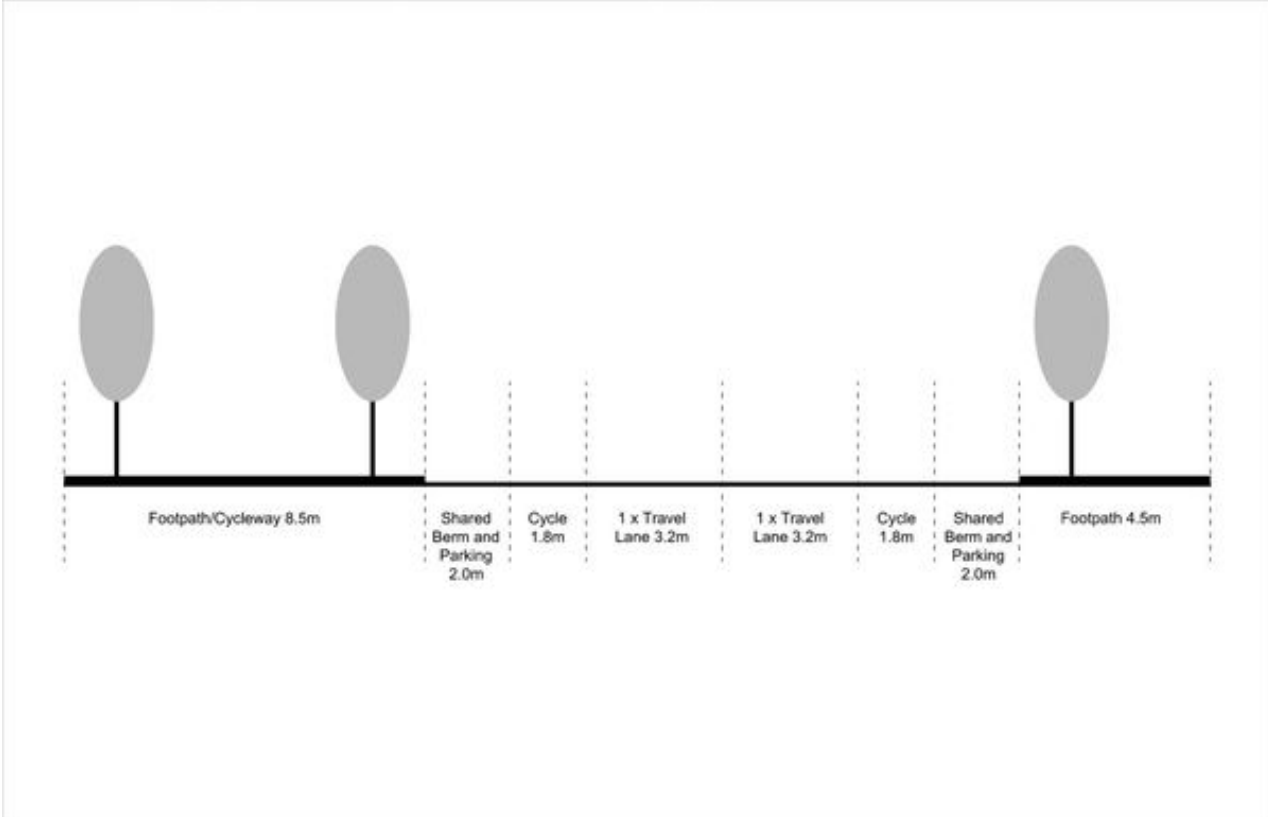

Appendix 3X4(c) - Movement Network Layer Diagram - Spine Road 1 (North West Belfast)

Appendix 3X4(c) - Movement Network Layer Diagram - Spine Road 1 (North West Belfast)

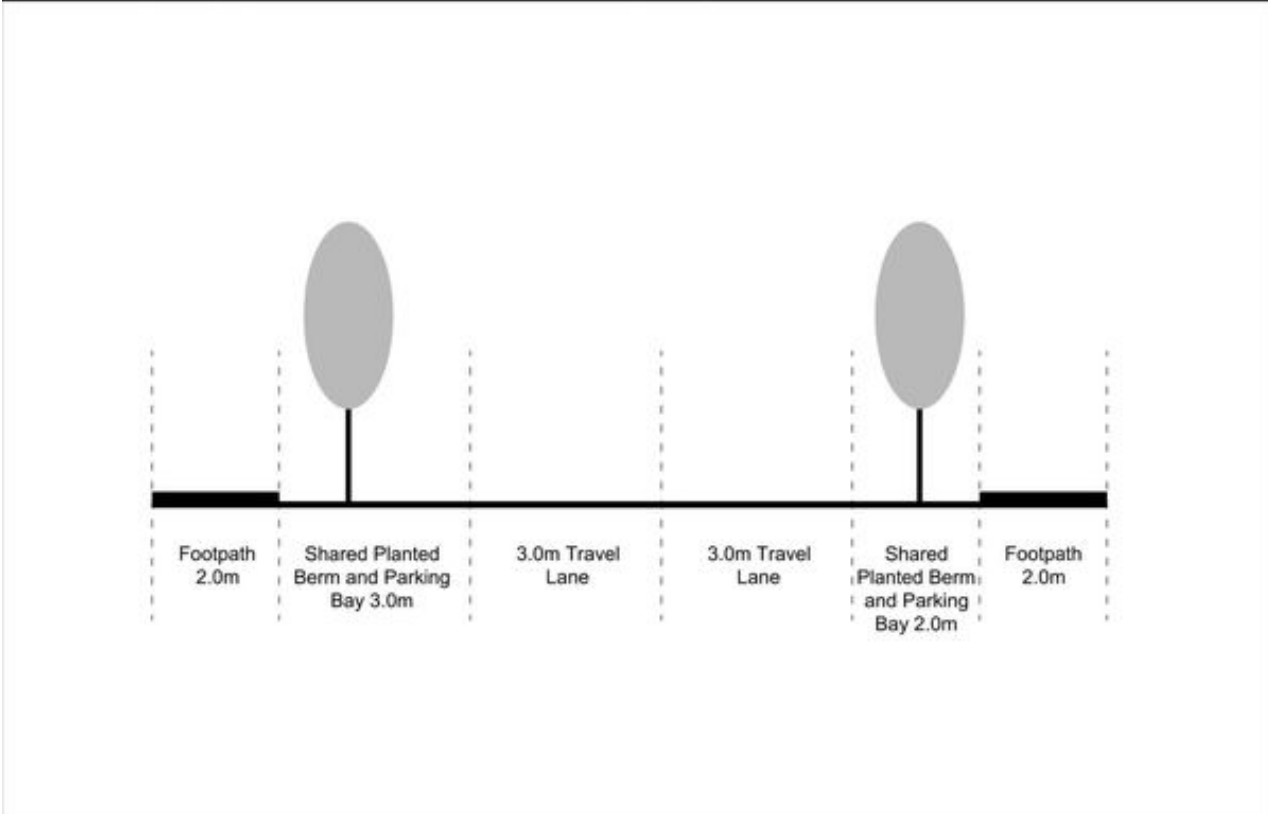

Appendix 3X4(d) - Movement Network Layer Diagram - Public Transport Network (North West Belfast)

Updated 14 May 2012

APPENDIX 3X4(d) - Living G (North West Belfast) Zone - Movement Network Layer Diagram - Public Transport Network

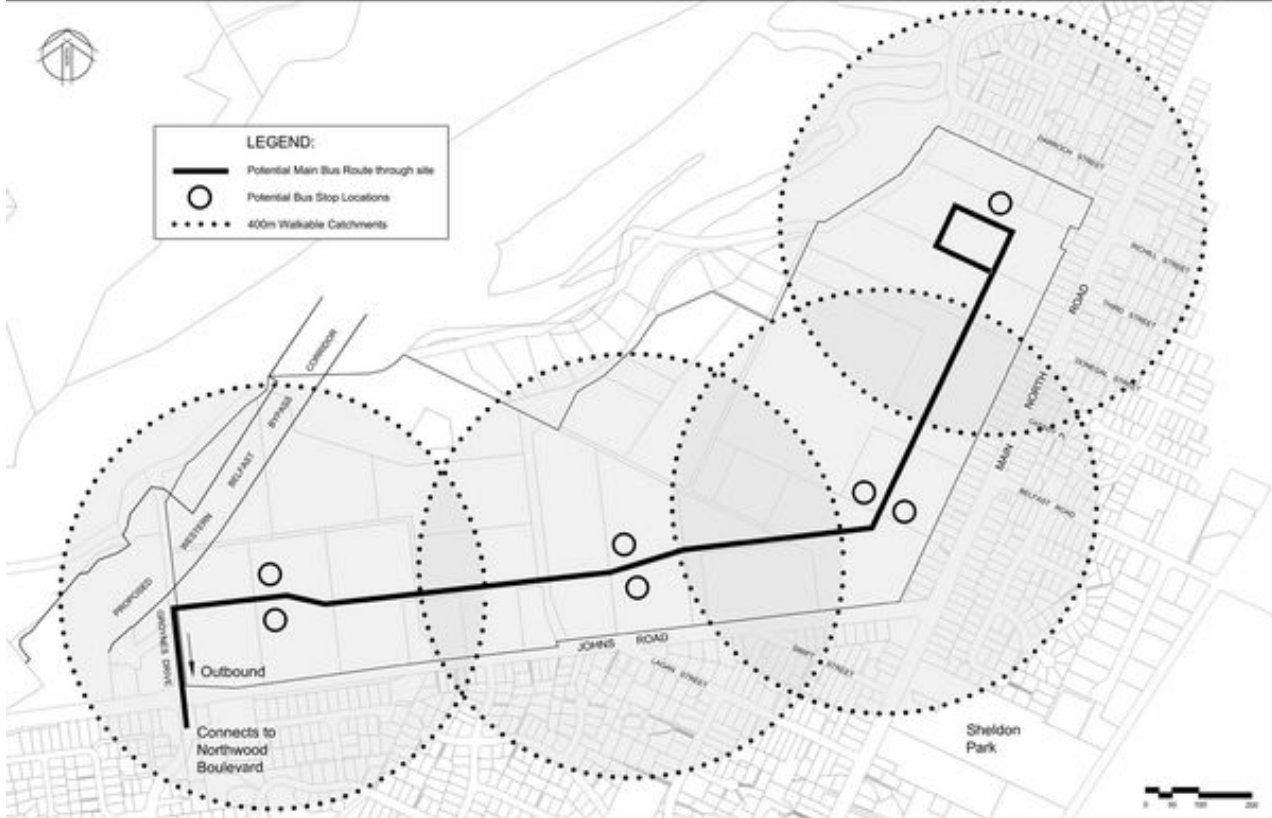

Appendix 3X4(e) - Movement Network Layer Diagram - Interim Public Transport Network (North West Belfast)

Updated 14 May 2012

APPENDIX 3X4(e) - Living G (North West Belfast) Zone - Movement Network Layer Diagram - Interim Public Transport Network

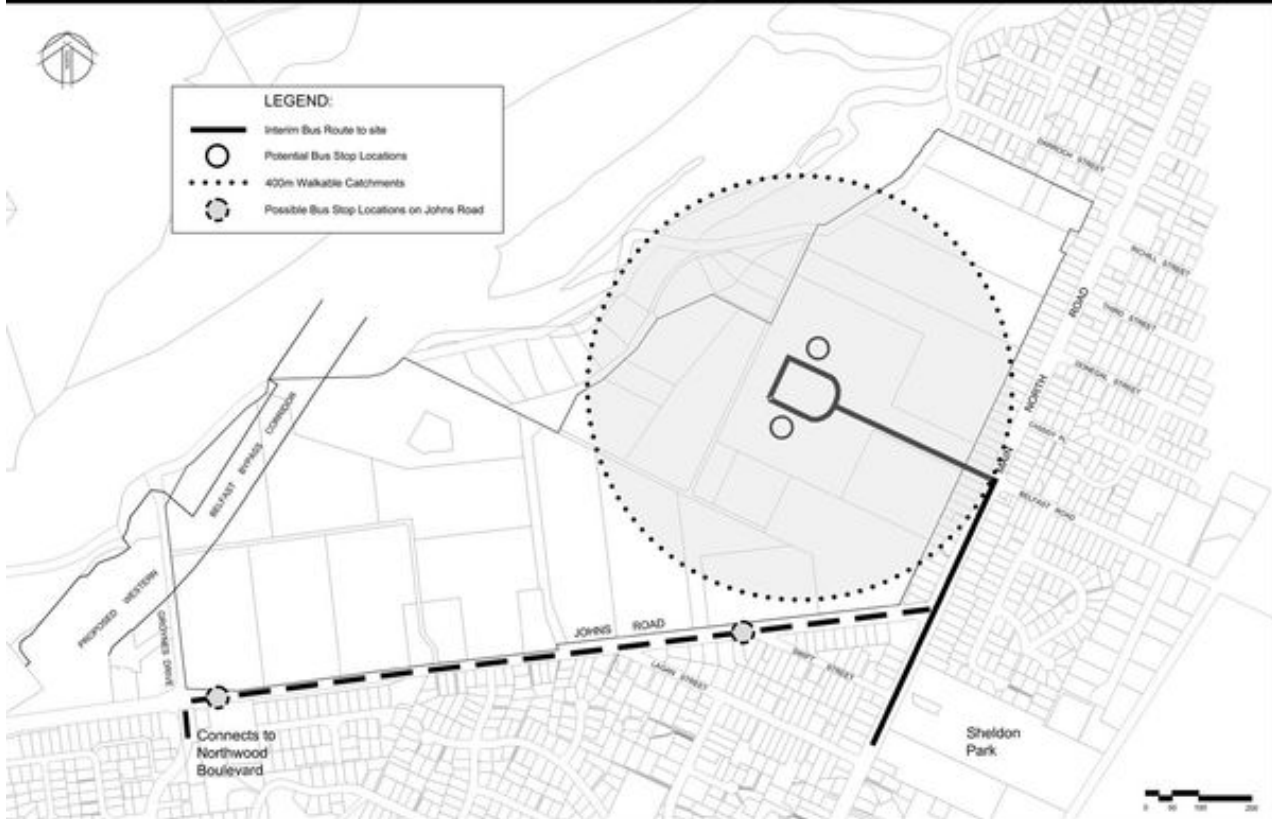

Appendix 3X4(f) - Movement Network Layer Diagram - Cycle Network (North West Belfast)

Updated 14 May 2012

APPENDIX 3X4(f) - Living G (North West Belfast) Zone - Movement Network Layer Diagram - Cycle Network

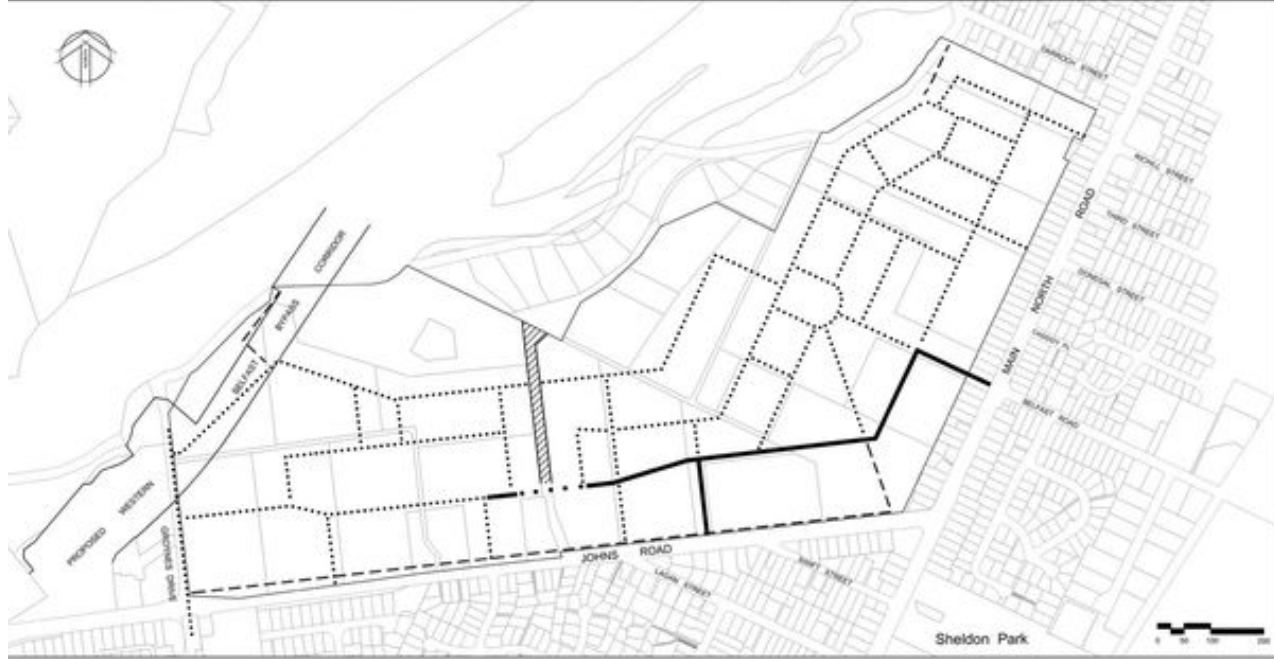

LEGEND:

- Public Greenway and Cycle Route
- On-Street Cycle Linkages
- Off-Street Cycle Path
- Crossing of Devondale driveway subject to agreement or obtainment under the Public Works Act
- Devondale Driveway

Appendix 3X4(g) - Movement Network Layer Diagram - Pedestrian Network (North West Belfast)

Updated 14 May 2012

APPENDIX 3X4(g) - Living G (North West Belfast) Zone - Movement Network Layer Diagram - Pedestrian Network



LEGEND:

- Primary Pedestrian routes with tree lined key walking linkages in streets and/or reserves
- Primary Pedestrian links to Wainmill Walkway
- Private Pedestrian right of way for benefit of Devondale Estate
- Secondary Pedestrian Routes
- Existing Pedestrian network to/from Sheldon Park
- Crossing of Devondale driveway subject to agreement or obtainment under the Public Works Act
- Devondale Driveway

Appendices 3Y(a) and 3Y(b) - Outline Development Plan (Highfield)

Updated 06 December 2013

Appendix 3Y(a) - Outline Development Plan (Highfield Park) - North

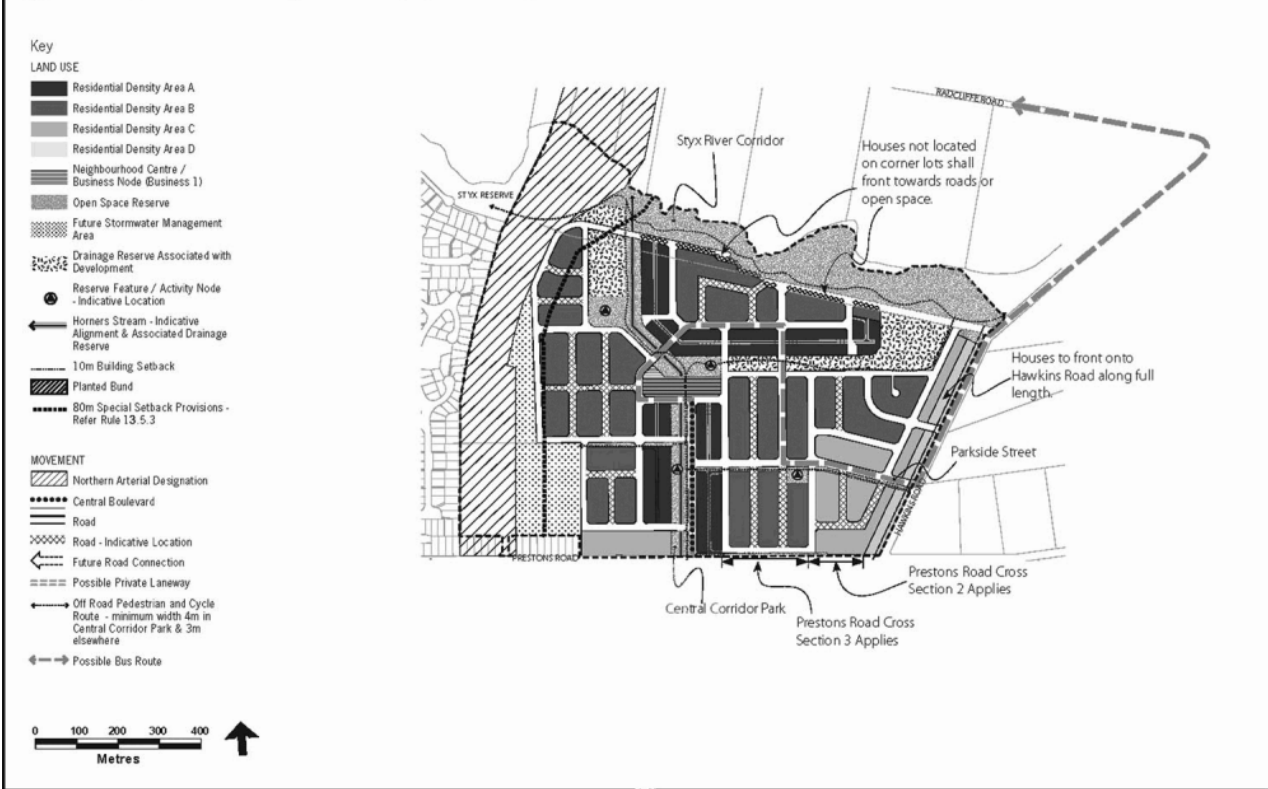

Appendix 3Y(b) - Outline Development Plan (Highfield Park) - South



Appendix 3Y(c) - Plant species for Living G (Highfield) zone

A: Native Plants

(i) Trees

Alectryon excelsus - titiki
Cordyline australis - cabbage tree
Dacrycarpus dacrydioides - kaihikatea
Elaeocarpus dentatus - hinau
Elaeocarpus hookerianus - pokaka
Pittosporum eugenioides - lemonwood
Plagianthus regus - lowland ribbonwood
Podocarpus totora - totora
Prumnopitys ferruginea - miro
Prumnopitys taxifolia - matai
Pseudopanax crassifolius - lancewood
Sophora microphylla - kowhai

(ii) Small tree and shrubs

Aristotelia serratus - wineberry
Carpodetus serratus - marbleleaf
Coprosma areolata
Coprosma linarifolia - yellow-wood
Coprosma lucida - shining karamu
Coprosma robusta - karamu
Coprosma rotundifolia - round leaved coprosma
Fuchsia excorticata - fuchsia
Griselinia littoralis - broadleaf
Hedycarpa arborea - pigeonwood
Hoheria angustifolia - lacebark
Lophomyrtus abcordata - NZ myrtle
Meliccytus ramiflorus - mahoe
Meliccytus micranthus - shrubby mahoe
Myrsine australis - red mapau
Neomyrtus pedunculata
Pennantia corymbosa - kaikomako
Pittosporum tenuifolium - kohuhu
Pseudopanax arboreus - fivefinger
Pseudowintera colorata - pepper tree
Strebilus heterophyllus - turepo

B: Exotic trees

Acer campestre - field maple
Acer negundo
Alnus glutinosa - black alder
Alnus rubra - red alder
Carpinus betulinus fastigata - upright hornbeam
Liquidambar styraciflua - liquidamber
Prunus species - flowering cherries
Platanus orientalis - plane
Quercus coccinea - scarlet oak
Quercus palustris - pin oak
Quercus robur fastigata
Tilia cordata - lime

Appendix 3Y(d) - Cross sections for Roads - Styx River/Selkirk Place, Hawkins Road, Hills Road and Prestons Road

Appendix 3Y(d) - Cross sections for Roads - Styx River/Selkirk Place, Hawkins Road, Hills Road and Prestons Road

Appendix 3Y(d) - Cross Sections for Roads: Styx River/Selkirk Place, Hawkins Road, Hills Road & Prestons Road.

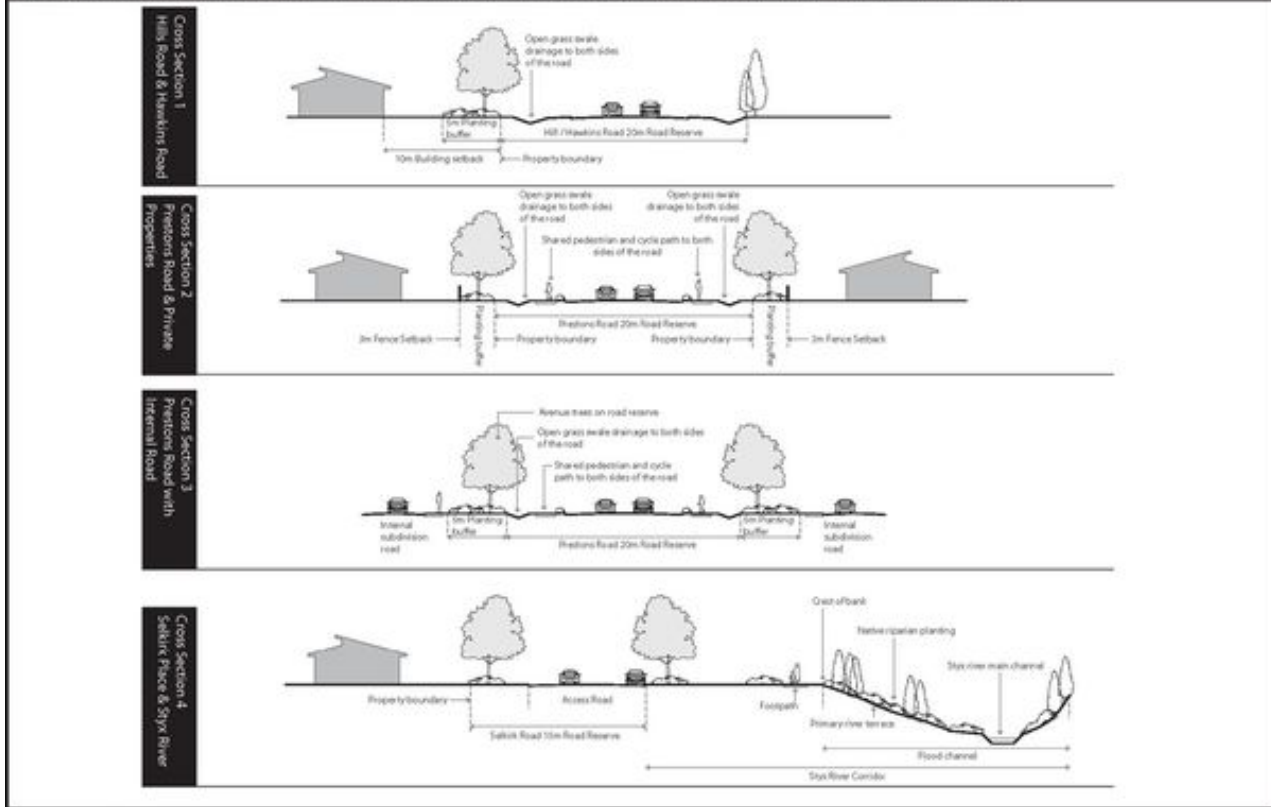

Appendix 3Z - Master Plan (Highsted)

Updated 06 December 2013

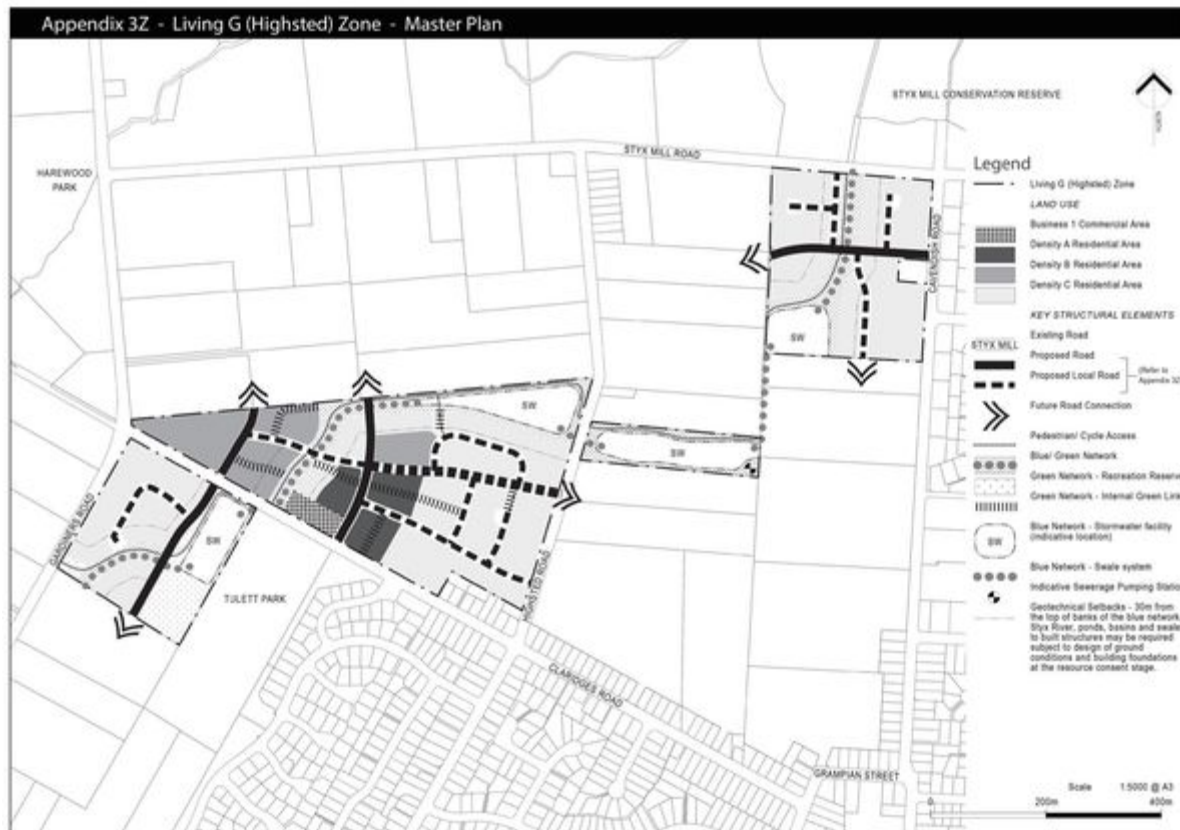

Appendix 3ZA - Movement Network (Highsted)

Updated 06 December 2013

Appendix 3ZA - Living G (Highsted) Zone - Movement Network

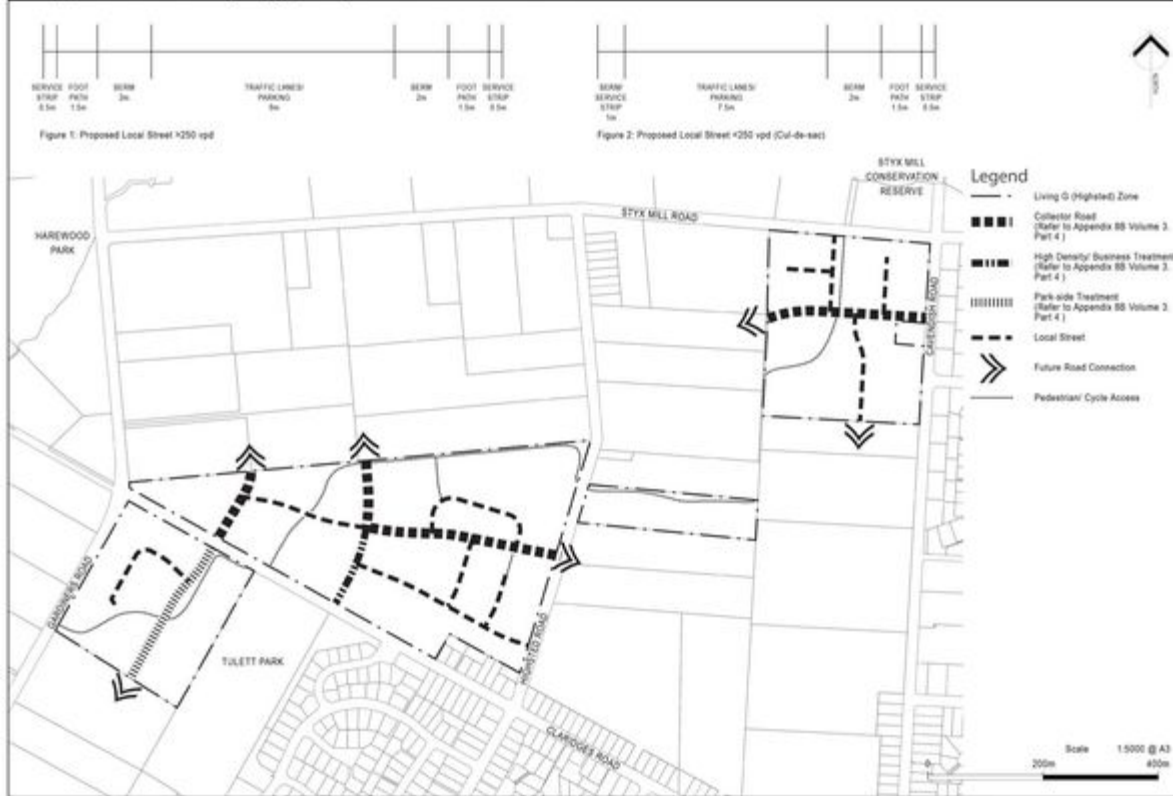

Appendix 4 - List of Special amenity areas (Sams)

Updated 29 January 2015

Appendix 4 - List of Special amenity areas (Sams)

Sam number	General location	Rules applicable (or other method)
1	Heathcote	Community based management plan
2	Beckenham Loop	Street scene
3	Tainui/Moana Streets	Street scene
4	Aynsley Terrace	Street scene
5	Cholmondeley Avenue	Street scene
6	Shand/Piko/Tika	Street scene; residential site density
7	Totara/Hinau/Puriri	Street scene
8	Fendalton (general)	Residential site density; outdoor living space
8a	Bradnor Street	Residential site density; outdoor living space
8b	Heathfield Street	Residential site density; outdoor living space; external appearance
9	River Road	Street scene
10	Slater-Poulton Avenue	Street scene
10a	Dudley Street	Street scene; external appearance
11	Heaton and Circuit Streets	Street scene; external appearance (community based management plan)
12	Massey Crescent	Street scene; residential site density

13	Francis Avenue	Street scene ; external appearance
14	Gosset-Roosevelt	Street scene; residential site density; and external appearance
15	Severn Street	Street scene
16	St James Avenue	Street scene
17	Hackthorne/MacMillan/Dyers	Street scene - assessment matter
17a	Hackthorne Road	External appearance
18	The Esplanade	Street scene; external appearance
19	Church Square	Street scene (community based management plan)
20	Rastrick Area	Height
21	Elm Grove/Hanmer Street	Street scene; residential site density; height (community based management plan)
28	Beverly Street	External appearance (community based management plan)
29	Ranfurlly Street	Street scene; external appearance
34	Auburn Avenue	Street scene; external appearance
35	The Spur	External appearance
36	St Andrews Square/Peel Street	Street scene
37	Emmett Street	Street scene
38	Clissold street	Street scene
39	Mays/Chapter/Weston	Street scene
40	Hawkesbury Avenue	Street scene
41	Naseby Street	Street scene

Appendix 5 - Deleted

Updated 14 November 2005

Appendix 6 - Areas to which alternative specific provisions apply - LHB Zone (Worsleys Road)

Updated 14 November 2005

Appendix 6. Areas to which alternative specific provisions apply - LHB Zone (Worsleys Rd)

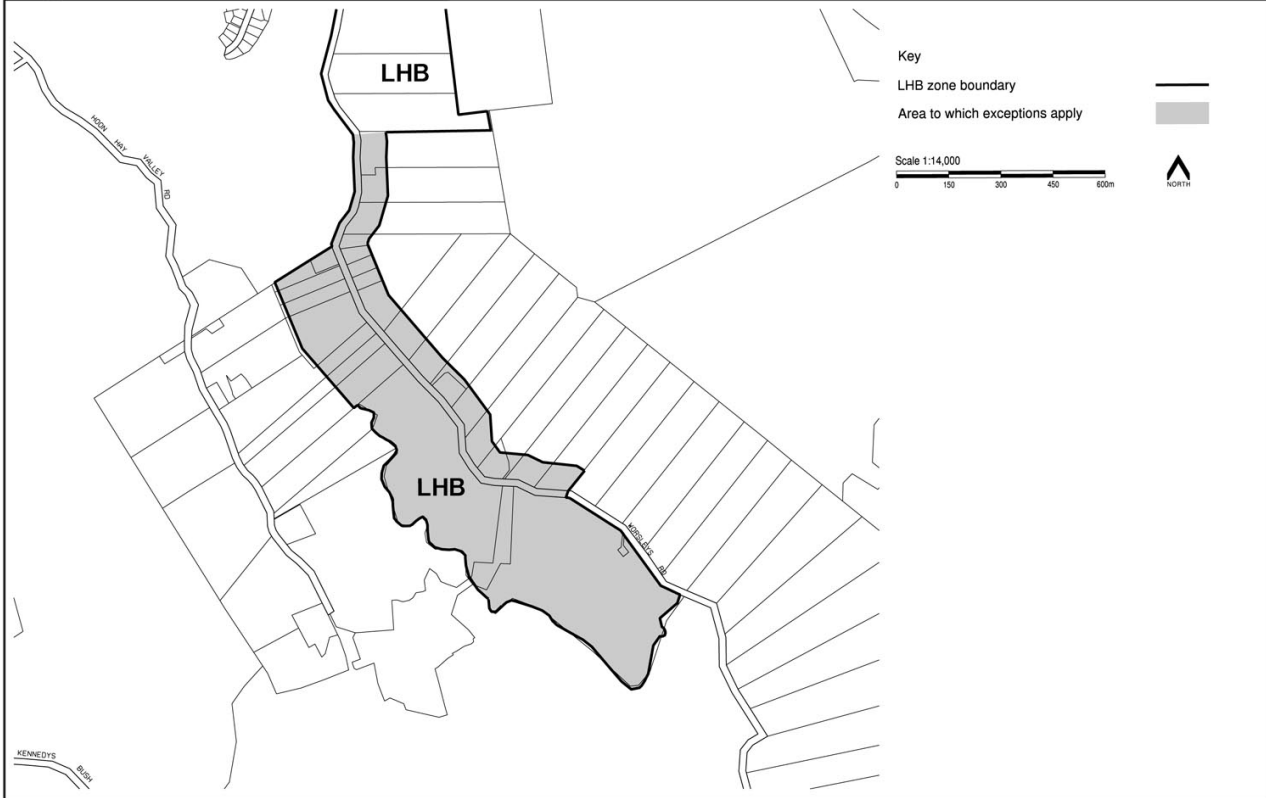

Appendix 7 - Areas to which additional provisions apply - LHB Zone (Worsleys Road)

Updated 14 November 2005

Appendix 7. Areas to which additional provisions apply - LHB Zone (Worsleys Rd)

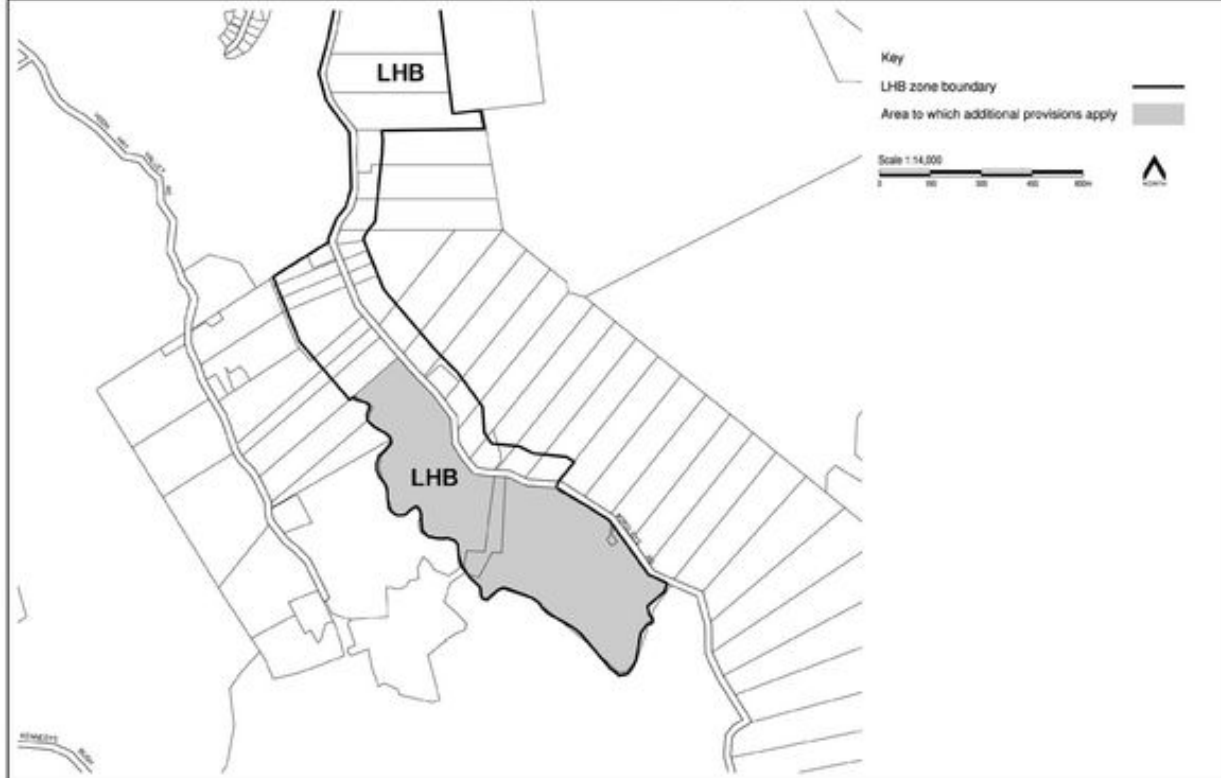

Appendix 8 - LHA Deferred 2008 Zone (Kennedys Bush/Cashmere Road)

Updated 14 November 2005

Appendix 8 - LHA Deferred 2008 Zone (Kennedys Bush/Cashmere Road)

Appendix 8. LHA Deferred 2008 Zone (Kennedys Bush/Cashmere Road)

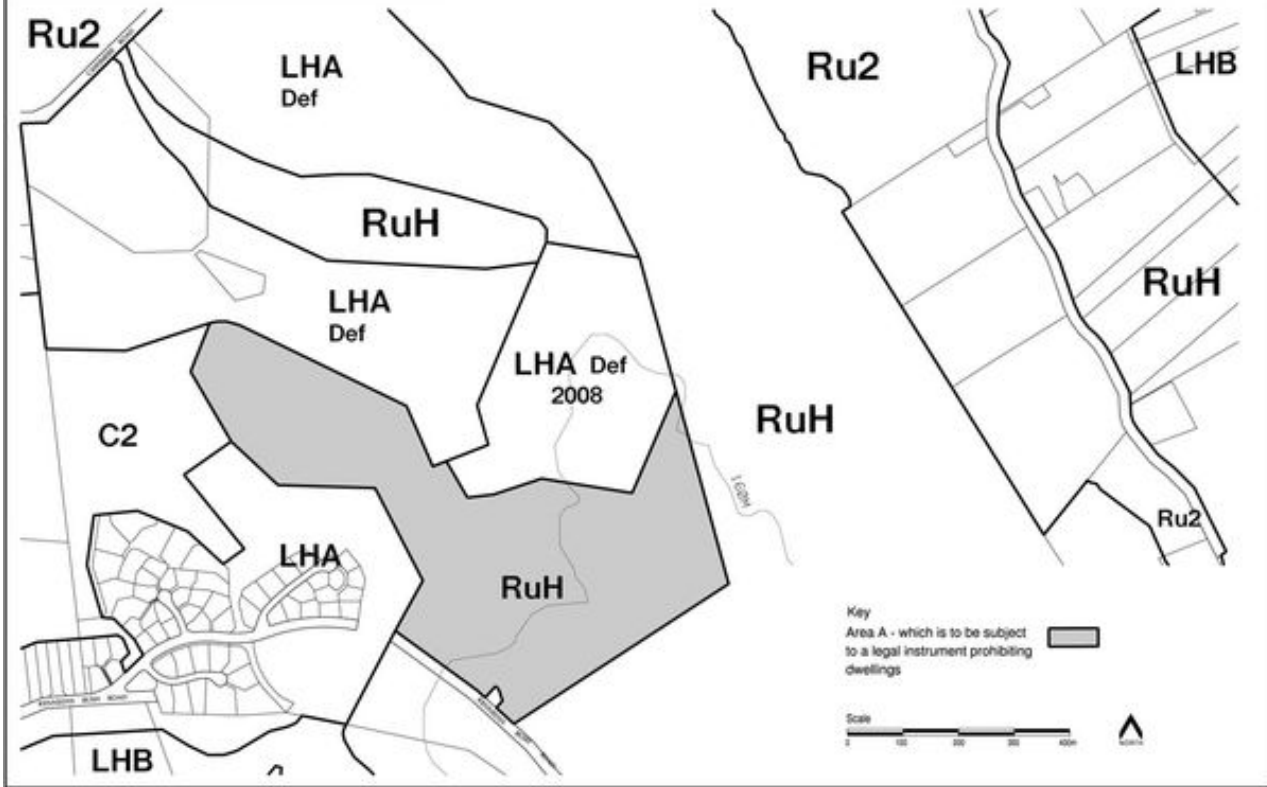

Appendix 9 - Areas to which additional building setback provisions apply - LH Zone (Montgomery Spur)

Updated 14 November 2005

Appendix 9 - Areas to which additional building setback provisions apply - LH Zone (Montgomery Spur)

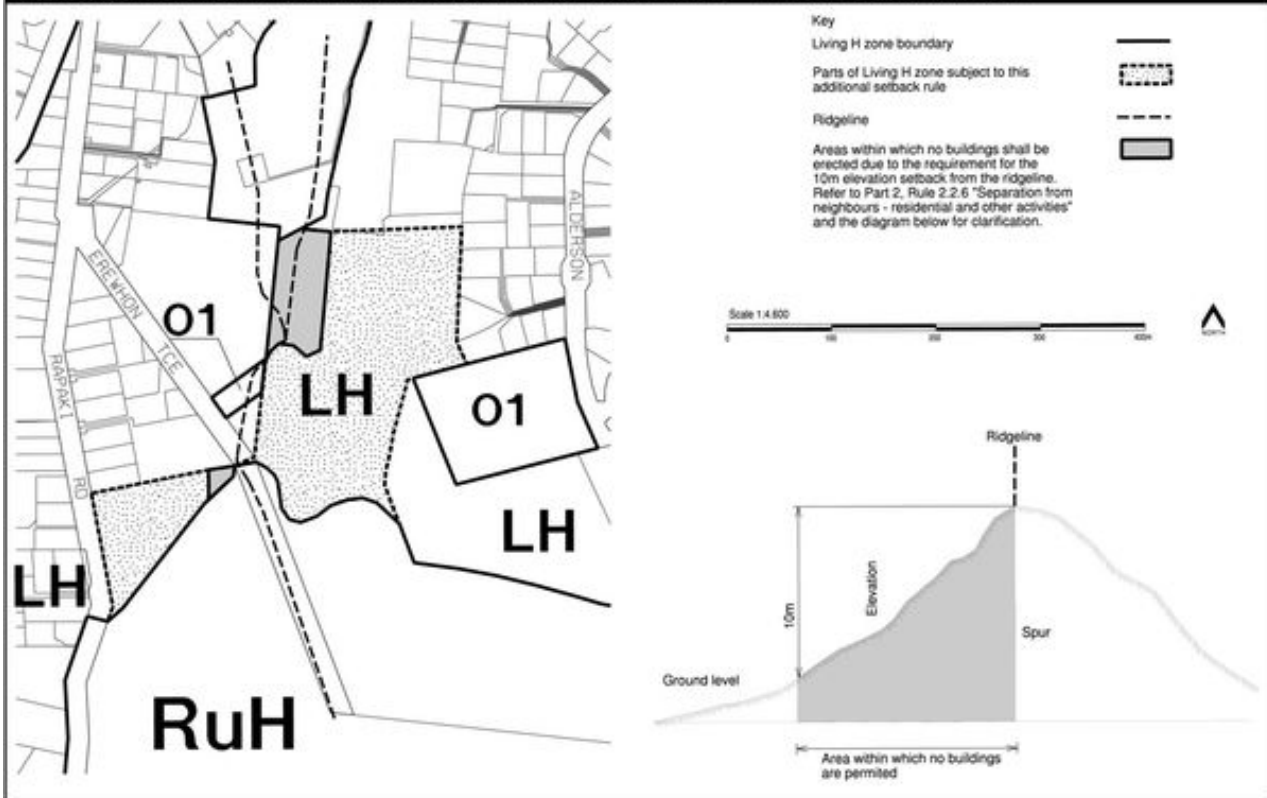

Appendix 10 - Living G High Density (A) and (B) Eastern and Southern Boundary Definition

Updated 8 November 2006

Appendix 10 - Living 3 High Density (A) And (B) Eastern And Southern Boundary D

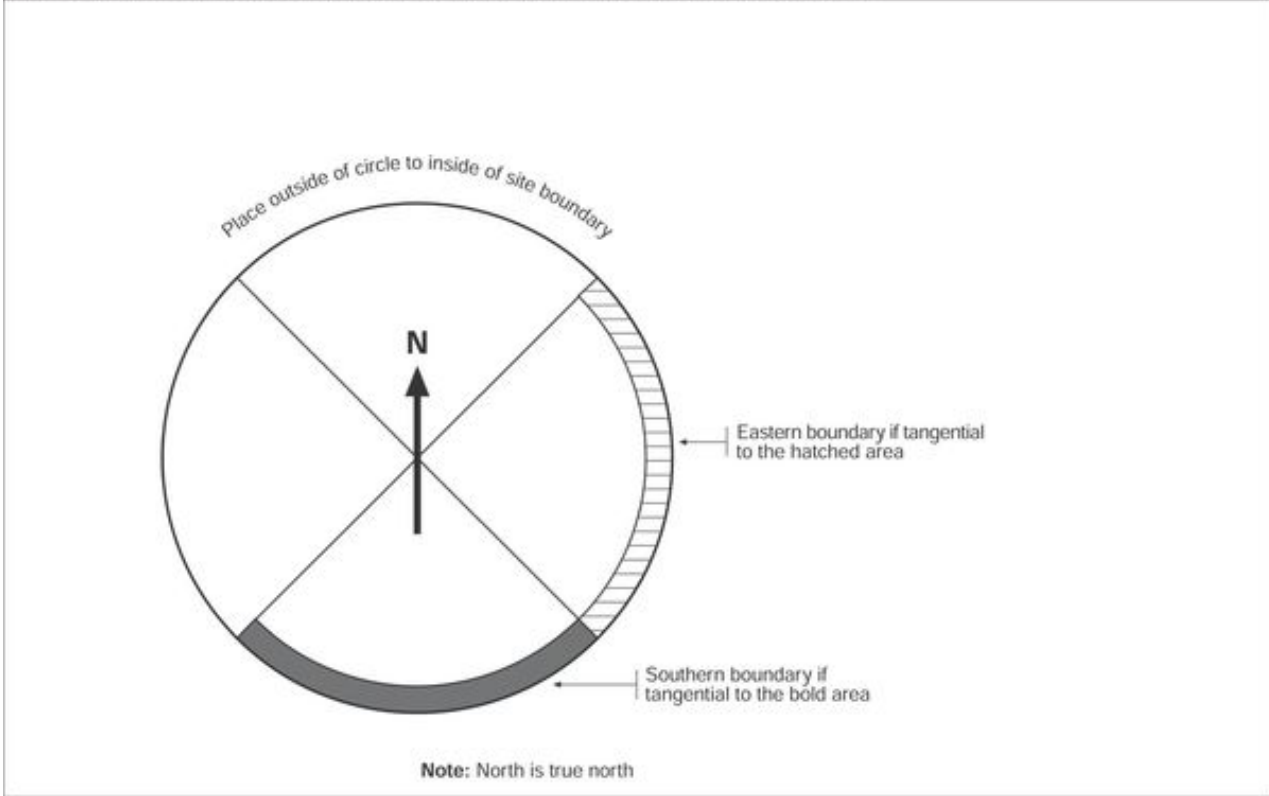

Appendix 11 - Development Plan (Living 3 and Business 1 Zones)

Updated 26 October 2010

New Appendix 11 - Development Plan (Living 3 and Business 1 Zones)

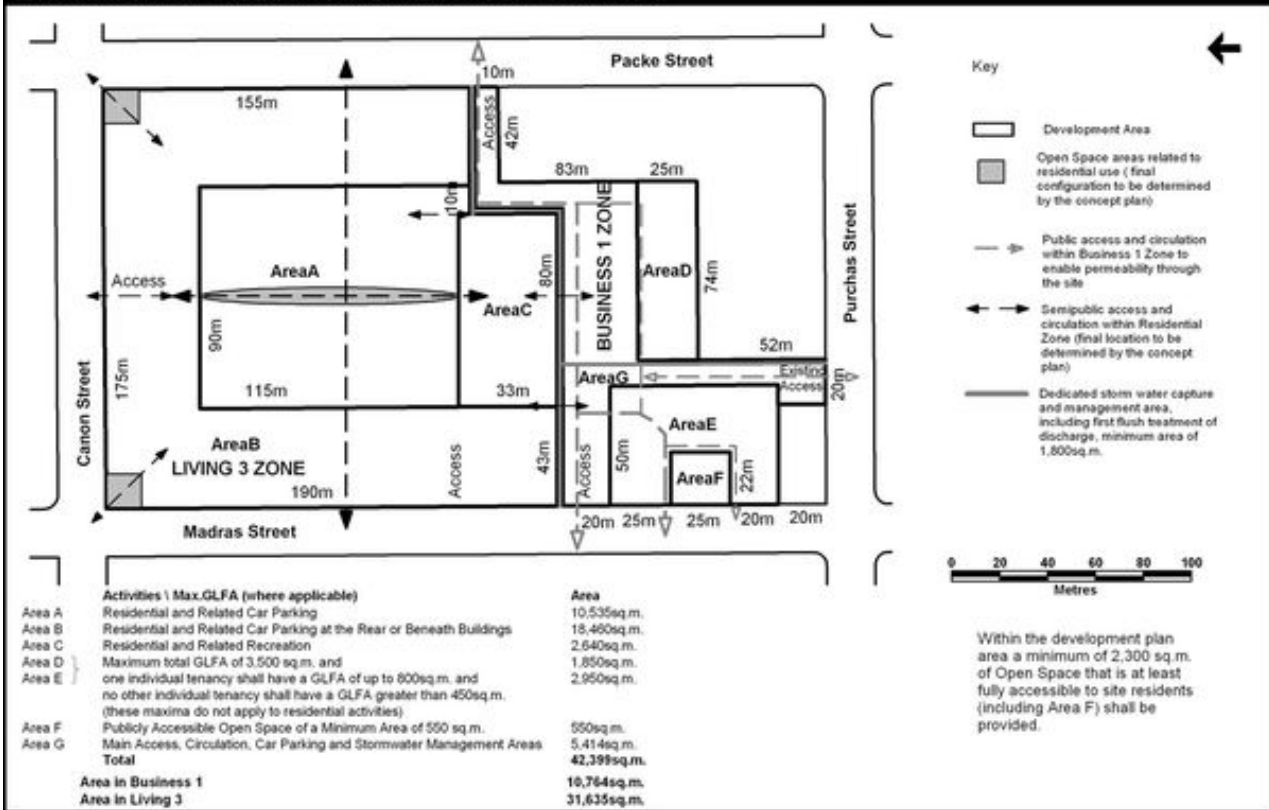

Appendix 12 - Area of 458 - 464 Ferry Road to which specific provisions in Part 2 - Living 2, Part 10 & 14 apply

Updated 18 January 2010

Appendix 12. Area of 458- 464 Ferry Rd to which specific provisions in Part 2 - Living 2, Part 10 & 14 apply

