

Rain garden design, construction and maintenance manual

**Christchurch
City Council**



Rain Garden Design, Construction and Maintenance Manual

Christchurch City Council, May 2016

Contributors

<u>Contributor</u>	<u>Position</u>
Ken Couling	Senior Planning Engineer, Christchurch City Council
Peter Christensen	Senior Environmental Engineer, CTN Consulting Ltd
Brian Norton	Planning Engineer, Christchurch City Council
Peter Wehrmann	Senior Engineer Water/Environmental, Christchurch City Council
Shane Moohan	City Arborist, Christchurch City Council
Jenny Moore	Senior Landscape Architect, Christchurch City Council
Howard Simpson	Team Leader, Water & Waste Tech Services & Design, Christchurch City Council
Dennis Preston	Team Leader, Park & Landscape Tech Services & Design, Christchurch City Council

Acknowledgements

Auckland Council	
Mark Stone	Senior Civil Engineer, Aurecon NZ Ltd
Mark Groves	Senior Environmental Engineer, Opus International Consultants Ltd

Version history

<i>Version</i>	<i>Date</i>	<i>Description</i>
Draft	30 June 2015	Draft for initial comments
Draft v2	22 October 2015	Draft for comments
Final v3	29 January 2016	Final
Final v4	23 March 2016	Update after feedback
Final v5	10 May 2016	Edited by comms - Linda Bennett, Peter Christensen

Cover photo: Rain garden in front of Christchurch Botanic Gardens Visitors Centre (Peter Christensen)

Table of Contents

Introduction	8
Part A: Design Guide	10
1 Components of a rain garden	10
2 Use and suitability	11
3 Location selection	12
4 Basic sizing procedure	13
4.1 Key parameters	13
4.2 Sizing formulae	14
5 Standard details	18
5.1 Typical cross-section	18
5.2 Typical layout plan	18
5.3 Layers in a rain garden	19
5.4 Rain garden ponding and layout examples	20
5.5 Overflows	21
5.6 Inlets	22
5.7 Sediment forebay	26
5.8 Edge support	26
5.9 Underdrain system	27
5.10 Outlet Control	29
5.11 Sample Engineering Drawings	30
6 Media selection	32
6.1 Filter media	32
6.2 Transition media	32
6.3 Drainage media	32
6.4 Mulch	32
6.5 Testing for contamination	32

6.6	Infiltration testing	33
7	Plant selection	34
8	Common design and construction issues	35
9	Stormwater tree pits	37
	Part B: Construction Guide	41
10	Construction sequence (with explanation for each)	41
10.1	Identify services and excavate	41
10.2	Form sides and lay geotextile (if required)	42
10.3	Install underdrainage	42
10.4	Construct overflow drainage	43
10.5	Backfill underdrainage system	44
10.6	Install transition (sand) layer	44
10.7	Install rain garden media mix	45
10.8	Complete to finished level	45
10.9	Planting	46
10.10	Place pebble mulch	46
10.11	Review levels	46
10.12	Test the rain garden	46
10.13	Completion and tidy up	47
10.14	Other notes	47
10.15	Quick checks	47
10.16	Things to avoid	47
	Part C: Maintenance Guide	49
11	Rain garden maintenance	49
12	References	53
	Appendix A: Specification	54
13	General	54

14 Abbreviations and definitions	54
15 Documents	54
16 Requirements	55
16.1 Qualifications	55
16.2 Acceptable product/material suppliers	55
16.3 Substitutions	55
16.4 As built documents	55
17 Products	56
17.1 Materials	56
18 Execution	59
18.1 Conditions	59
18.2 Installation/application	59

List of Tables

Table 1 Key rain garden design parameters	13
Table 2 Typical Dimensions for a rain garden in a residential street	17
Table 3 Recommended plants for rain gardens in Christchurch	34
Table 4 Summary of Key Design and Construction Constraints	35
Table 5 Example of Rain Garden Issues Requiring Maintenance	50
Table 6 Inspection and Maintenance Tasks for Rain Gardens (Source: FAWB, 2009, adapted for Christchurch City Council)	51

List of Figures

Figure 1 Commons demonstration rain garden	8
Figure 2 Key components of a rain garden	10
Figure 3 Size relationship between EDD and filtration area with two possible configurations	13
Figure 4 Example rain garden calculation sheet using Equations (1) and (2)	16
Figure 5 Typical cross section	18
Figure 6 Typical rain garden layout plan	18
Figure 7 Rain garden layers	19
Figure 8 Example of a cul de sac rain garden layout	20
Figure 9 Example of a berm or build out rain garden	20
Figure 10 Dome sump overflow	21
Figure 11 Double sump on batter slope overflow	21
Figure 12 Dual function kerb exit overflow/entry	22
Figure 13 Fender discharge entry detail	22
Figure 14 Rear sump entry	23
Figure 15 Rear sump entry (back of kerb filtered discharge)	23
Figure 16 Rain garden inlet for filtered discharge (submerged bubble up acting as a gross debris trap)	24
Figure 17 Back of kerb discharge	25
Figure 18 Sediment forebay	26

Figure 19 Standard edge support	26
Figure 20 Edge support with a containment wall	27
Figure 21 Precast concrete walls allow for fast installation	27
Figure 22 Underdrain system for rain gardens containing trees (to prevent root intrusion)	28
Figure 23 Inspection standpipe	28
Figure 24 Choked pipe outlet control	29
Figure 25 Sample rain garden with no trees and discharging to a shallow stormwater outfall	30
Figure 26 Sample rain garden with tree and discharging to a shallow stormwater outfall	31
Figure 27 Stormwater tree pit schematic	38
Figure 28 Passive irrigation tree pit plan	38
Figure 29 Passive irrigation tree pit cross-section (example only)	39
Figure 30 Grove Rd rain garden during infiltration testing	41
Figure 31 Construct edge walls as specified. The soil below rain garden should be loosened with teeth on excavation bucket to 300mm below surface.	42
Figure 32 Construct Overflow structures if needed. Ensure services are identified and protected appropriately.	43
Figure 33 Install appropriate under drainage system.	44
Figure 34 Place drainage layers and rain garden media from a low level and spread manually	44
Figure 35 Rain garden media contoured to form ponding area.	45

List of Acronyms

AEP	Annual Exceedance Probability
CCC	Christchurch City Council
WQV	Water Quality Volume

Introduction

Christchurch's natural waterways and estuary, as well as its groundwater resources, are key assets of the city which require protection. Urban stormwater runoff can have adverse effects on the drainage, ecological, cultural, recreational, landscape and heritage values of waterways. Discharge of untreated stormwater to groundwater can also affect the quality of shallow groundwater.

Rain gardens are engineered gardens designed to harness the natural ability of vegetation and soils to treat stormwater (Figure 1) and are sometimes called bio-retention devices. Treatment occurs through sedimentation, filtration, adsorption and uptake by vegetation. They can be used to reduce the effects of stormwater volumes, peak flows and contaminant loads on waterways.



Figure 1 Commons demonstration rain garden

This guide provides an overview of the design, construction and maintenance of rain gardens located in streets or other paved areas in Christchurch. Propriety rain garden systems are not covered.

Part A outlines the design philosophy adopted by Christchurch City Council. This includes location selection, the design parameters, and specification of components of a rain garden such as plants and media.

Part B contains a simple step-by-step guide of the basic construction details. This is based on international best practice and experience built up within Christchurch.

Part C is a maintenance guide which covers the key maintenance tasks for a rain garden. These are particularly important as one of the primary causes of failure of rain gardens is poor maintenance.

The guide concludes with a sample specification in Appendix A.

Stormwater tree pits can be considered a special type of rain garden that accommodates a large tree.

The treatment mechanism and form is largely the same and most design, construction and maintenance aspects of rain gardens also apply to tree pits. Some differences are highlighted in Section 8: Stormwater tree pits.

Part A: Design Guide

1 Components of a rain garden

Rain gardens help remove pollutants and slow down stormwater flows, recharge freshwater bodies and look attractive. Rain gardens work by ponding stormwater in the planted area, which is then filtered through the soil mix and by plant roots. These absorb and filter contaminants before stormwater flows into surrounding ground, pipes, drains and streams, and eventually to the sea.

The key components of a rain garden are shown in Figure 2. Each component is required to ensure that a rain garden operates effectively.

Generally, a slotted or perforated pipe underdrainage system within a granular drainage layer is included at the bottom of a rain garden if the rain garden is connected to the stormwater pipeline in the street.

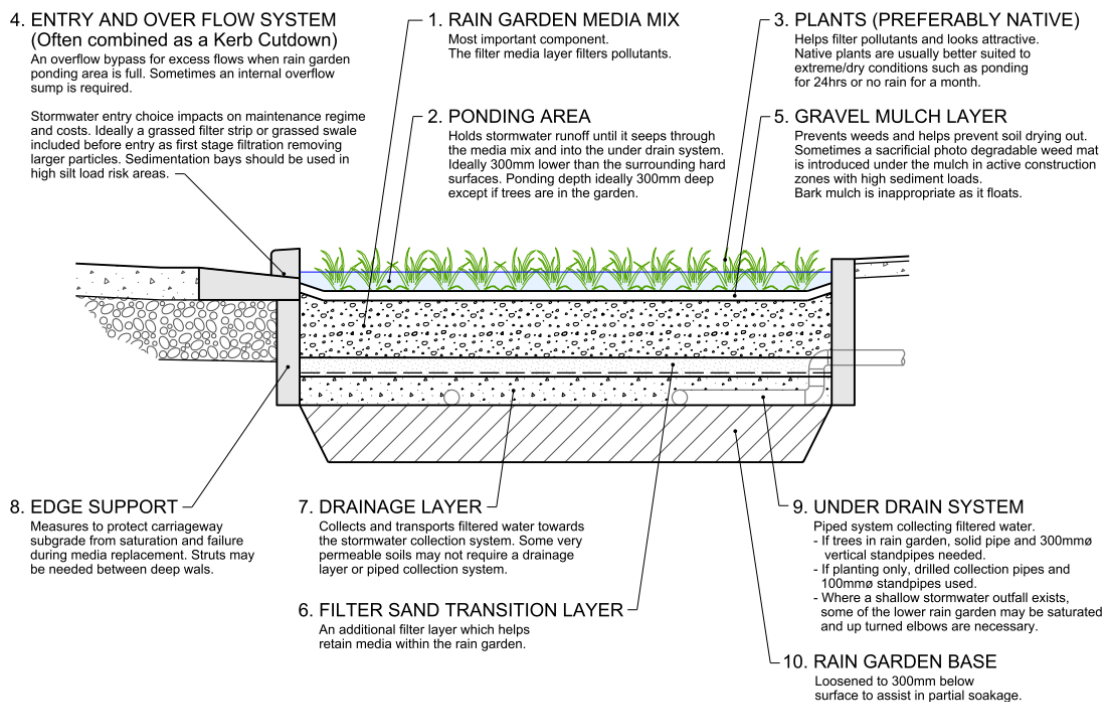

TYPICAL CROSS SECTION

Figure 2 Key components of a rain garden

Use and suitability

Rain gardens are generally most suitable for retrofit into existing developed areas where urban intensification or redevelopment is taking place. In greenfields or large brownfields development, basins and wetlands remain the Council's preferred stormwater quality treatment device due to higher amenity value and lower maintenance costs.

Rain gardens are generally preferred over proprietary filtration units as they provide multi-value benefits such as improved street amenity, higher stormwater pollutant removal and runoff attenuation during small to medium storms.

In retrofit situations, rain gardens can be installed in an existing road corridor, typically utilising some of the space set aside for on-street parking. They can also be installed during street renewals, particularly when narrowing is taking place.

Where urban intensification is occurring, rain gardens can help offset the effects of increased imperviousness on stormwater quality and quantity. They also increase the value of such development through the improved amenity they offer.

Volume treatment efficiency and cost per unit impervious area compare favourably against soil adsorption basins and storm filters. A regular maintenance regime is very important to achieve good treatment outcomes in the long-term. The cost of such a regime is likely to be higher than for basins and wetlands, but similar to storm filters.

Rain garden size

Rain gardens require a relatively small footprint area for a high level of treatment achieved (often approximately 3% only of their contributing catchment impervious area) and they are suitable for use on a range of catchment sizes from street-scale (1 to 3 ha block) to larger areas (4 to 10 ha).

A maximum footprint area of 1,000 to 1,200 m² is recommended. The maximum area is dictated by constructability to achieve even infiltration rates, even flow distribution and maintenance practicability.

2 Location selection

Rain gardens are suitable for most locations including individual sites, public roads and new subdivisions. They are particularly suitable for residential zones and retrofit situations in public streets. They are best avoided where available head is low (< 300 mm), groundwater is high (see below), a high sediment load is expected, on steep grades, in areas with lots of underground utility services and in areas of heavy industry.

Situations not covered by this guide

- Industrial areas
- High sediment loads
- Hill areas (> 3% grade)
- Areas with climatic conditions dissimilar to Christchurch City

Fall is required through any stormwater treatment device. Rain gardens are particularly suitable when retrofitting treatment into existing urban areas because the necessary head will often exist between the invert of the street channel and the stormwater pipe in the street, or the base of the rain garden if it is permeable.

Rain gardens are not suited to areas with high groundwater as they may become waterlogged for long periods which could result in drowning of the plants and leaching nutrients into receiving waterways. Without specific design, the base of the rain garden (i.e. the bottom of the transition layer) for the non-submerged case should be at least 300 mm above the seasonally high groundwater level. For submerged rain gardens, the bottom of the transition layer should be above the seasonally high groundwater level. Typically, the seasonally high groundwater level needs to be at least 800 mm below ground for a site to be suitable for a rain garden.

For many locations in Christchurch, the seasonally high groundwater level can be estimated by taking a field measurement during October.

Generally, rain gardens need to be connected to a stormwater pipeline in the street to avoid water logging. Where the underlying soil is very permeable (i.e. an initial infiltration rate of at least 50 mm/hr, but ideally higher), rain gardens may discharge directly to ground through the base of the rain garden.

Depth to median or seasonally high groundwater levels determine site suitability and whether rain gardens need to be designed as submerged outlet rain gardens.

In some locations, the amenity value provided by a rain garden that does not meet design guidelines may be acceptable. A landscape feature that offers some stormwater quality improvement is better than none.

3 Basic sizing procedure

The basin sizing procedure gives the designer an overview of rain garden design and highlights the key parameters agreed for use by Christchurch City Council.

3.1 Key parameters

The recommended design parameters which achieve greater than 80% runoff volume capture are illustrated in Figure 2 in Section 1 and described in Table 1.

Table 1 Key rain garden design parameters¹

First flush depth to achieve 80% annual volume capture	20 mm
Media depth	Ideally 600 mm (except where nitrogen is the primary pollutant in which case a depth of 900 mm is required). 300mm minimum.
Media infiltration rate	Initial: 50-150 mm/hr Design: 30 mm/hr
Minimum extended detention ponding volume	40% of first flush volume (V_{ff})
Outlet configuration	Drowned outlet with soffit of outlet at top of transition layer
Minimum depth to seasonally high groundwater	At least 800 mm (for minimum rain garden layer thicknesses)
Extended detention depth (EDD or ponding depth)	300 mm maximum (consider reducing in high pedestrian areas)

A key point to note is that the filtration area does not need to be the same size as the EDD or ponding area. This is illustrated in Figure 3. This shows that the EDD is often much larger than is required for the filtration area. For a typical rain garden where the EDD is 300 mm and the filtration depth is 600 mm, then the EDD is approximately 1.25 times the size of the filtration area. Realising this can reduce the cost of constructing a rain garden and make edge detailing, particularly adjacent to carriageways, easier. It also means that up to 50% of the EDD could be separated from the filtration area.



Figure 3 Size relationship between EDD and filtration area with two possible configurations

¹ The background to the choice of these parameters is provided in Christensen (2014).

3.2 Sizing formulae

Rain gardens size is dependent on the incoming first flush volume and the depth of the storage selected. The methodology below reflects the sizing procedure suitable for rain gardens within the flat areas of Christchurch City.

3.2.1 Calculation of filter area

The filter area is calculated using Equation (1) below.

$$A_{rg} = 41.67 \cdot \frac{(V_{ff})(d_{rg})}{k(h+d_{rg})t_{rg}} \quad \text{Equation (1)}$$

Where:

Symbol	Description	Unit	Recommended value
A_{rg}	= filtration area of rain garden	m ²	Calculated
V_{ff}	= first flush or first flush volume	m ³	Determined as per Equation 6-2 in WWDG and using 20mm as the first flush runoff depth
d_{rg}	= filter depth	m	0.6 (includes transition layer)
k	= coefficient of permeability	mm/hr	30
h	= average height of water	m	0.15 (half the recommended extended detention depth (EDD) of 300 mm)
t_{rg}	= time to pass V_{ff} through soil bed	day	One

The number 41.67 in Equation (1) is a conversion factor from mm/hr units to m/day.

Sizing rain gardens in areas with severe constraints

In some retrofit areas with constraints due to underground services or shallow stormwater pipes (e.g. central city streets), it can be difficult to capture the full first flush volume. Where this is the case, the Council may consider a tiered approach to sizing stormwater treatment measures to achieve the best possible outcome. This approach is summarised below:

- Where possible size rain gardens and stormwater tree pits to capture 80% of stormwater runoff volume.
- If the above target is not viable, size treatment measures to capture at least 75% of total suspended solids (TSS) using a measure such as continuous simulation water quality modelling or equivalent.
- If the above target is not viable, consider alternative treatment devices or design street trees as passive irrigation tree pits.

3.2.2 Extended detention area

In addition to the above formula there needs to be control over the minimum size of the rain garden. This is achieved by requiring the above ground storage to be at least 40% of the V_{ff} and this has been adopted in this report. Therefore, in conjunction with the above formula, there needs to be a second formula specifying a minimum rain garden size as follows:

$$A_{EDD} \geq \frac{0.4 \cdot V_{ff}}{(2 \cdot h)} \quad \text{Equation (2)}$$

Where:

A_{EDD} = Extended detention (storage) area of rain garden (m^2)

This prevents under sizing of rain gardens through the use of excessively high infiltration rates and shallow beds which would result in less than 80% annual volume capture through not providing sufficient storage. It is noted that some proprietary rain gardens have very high infiltration rates, but these are not covered by this guide.

Figure 4 Example rain garden calculation sheet using Equations (1) and (2)

Water quality volume			
Input parameters			
Total catchment area	A	10,000 m ²	
Zone		L1	
Composite first flush coefficient	C _{ff}	44 %	(From WWDG)
First flush depth		20.0 mm	
Intermediate calculations			
Water quality area	A _{wq}	4,400 m ²	(A x C _{ff})
Outputs			
Volume of first flush	V _{ff}	88 m ³	(20 mm x A _{wq})
Minimum live storage			
Outputs			
Minimum live storage	LS	35.2 m ³	(40% of V _{ff})
Filtration area of rain garden			
Input parameters			
Volume of first flush	V _{ff}	88 m ³	
Planting soil depth	d _{rg}	0.6 m	
Coefficient of permeability	k	30 mm/hr (0.72 m/day)	
Average height of water (half maximum depth)	h	0.15 m	
Time to pass V _{ff} through soil bed	t _{rg}	1.0 day	(Recommended)
Outputs			
Filtration area of rain garden	A _{rg}	98 m ²	(Equation (1))
Storage provided by this surface area	S	29 m ³	(2h x A _{rg})
Extended detention (storage) area of rain garden	A _{EED}	117 m ²	(Equation (2))

The worked example above shows that the rain garden filter area should be 98 m² and the area of the storage above the rain garden should be 117 m².

The approximate dimensions for a representative rain garden of this size in an existing residential street are given in Table 2.

Table 2 Typical Dimensions for a rain garden in a residential street

Parameter	Value
Typical residential block area	1 ha
Living zone	L1
Road reserve width	20 m
Width available for rain garden (including a 2 m wide buildout)	5 m
Rain gardens total surface area	117 m ²
Total length of rain gardens	23 m
Loss of car parks	4
Rain garden footprint as a percentage of impervious area	2.6%

4 Standard details

4.1 Typical cross-section

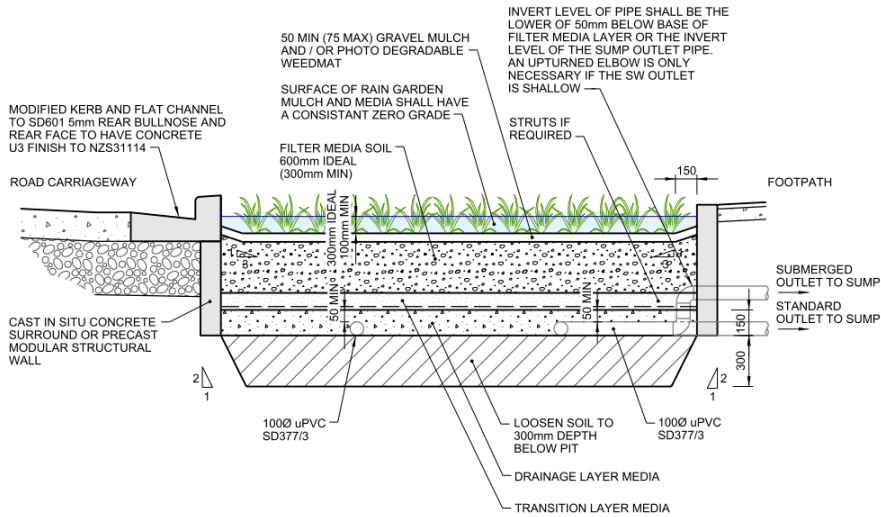

TYPICAL CROSS SECTION

Figure 5 Typical cross section

Use battered edges instead retaining walls if there is sufficient space (See Section 5.9).

4.2 Typical layout plan

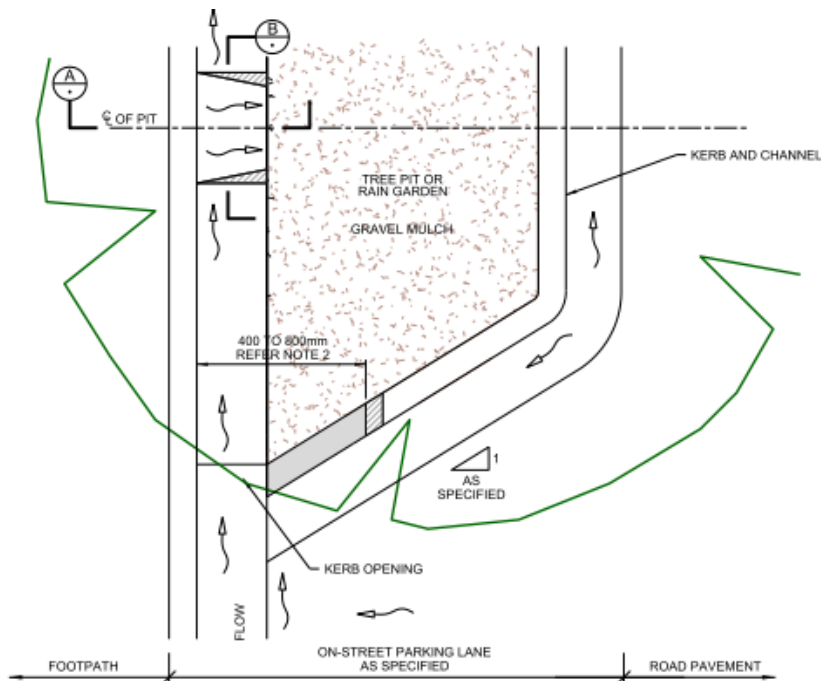
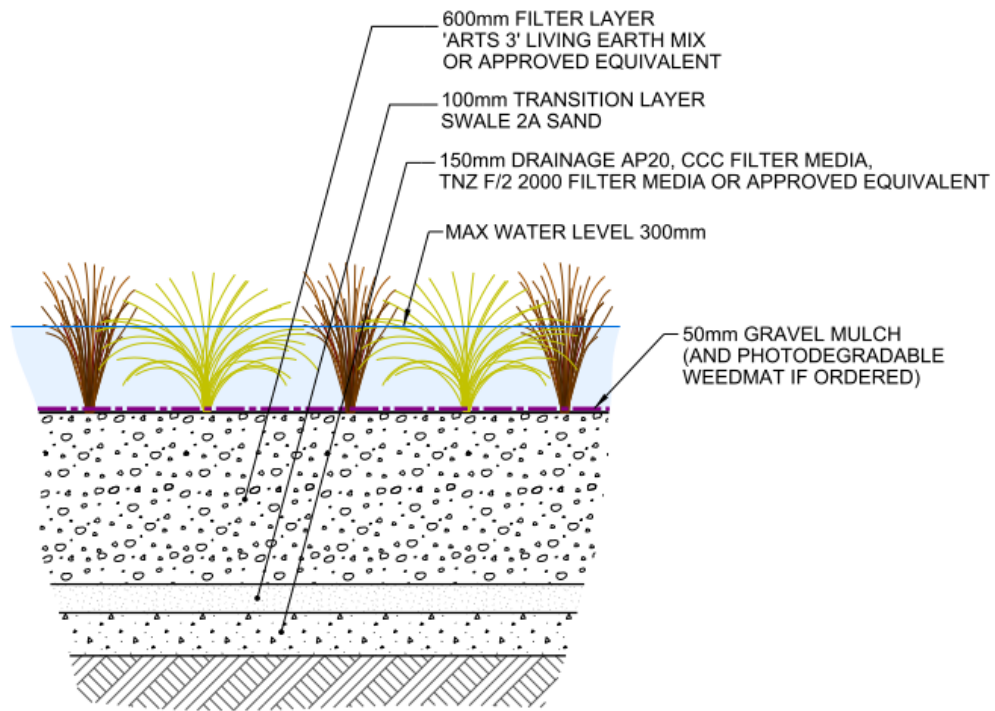

Figure 6 Typical rain garden layout plan

(Refer to entry detail for this layout plan in Section 5.7.)

4.3 Layers in a rain garden



RAIN GARDEN LAYERS

Figure 7 Rain garden layers

4.4 Rain garden ponding and layout examples

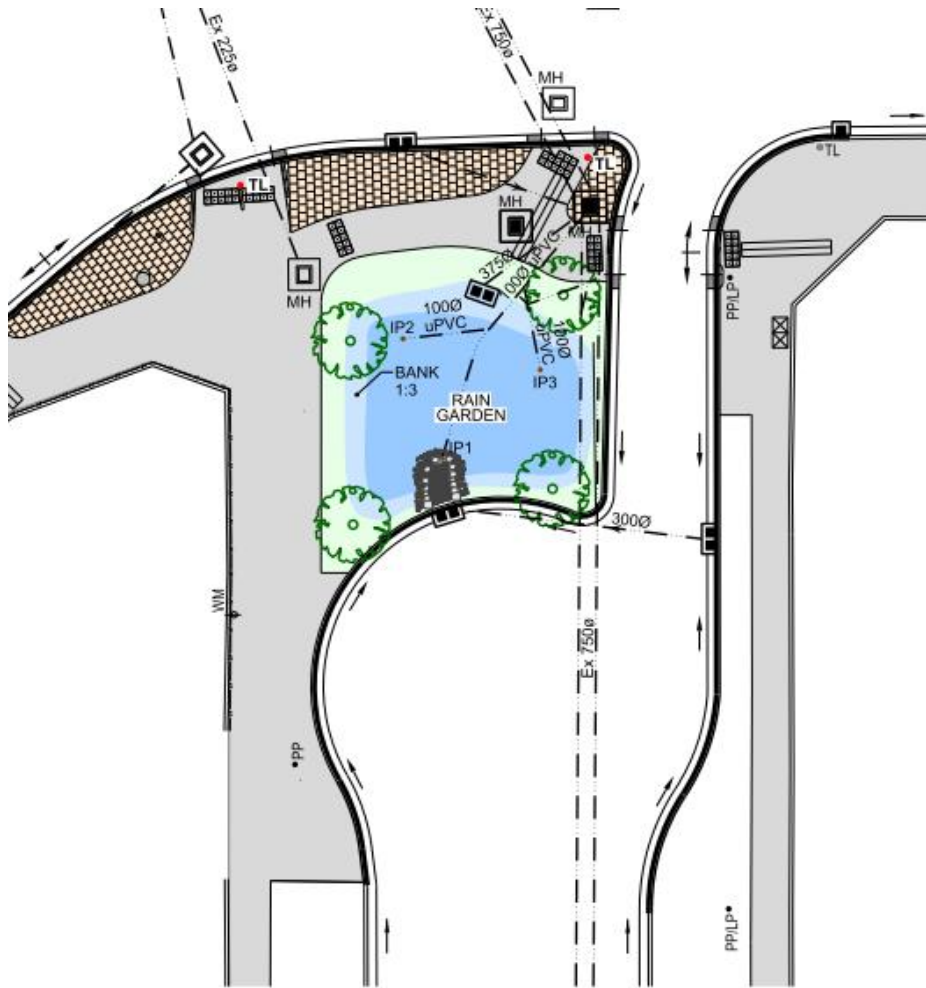

Figure 8 Example of a cul de sac rain garden layout

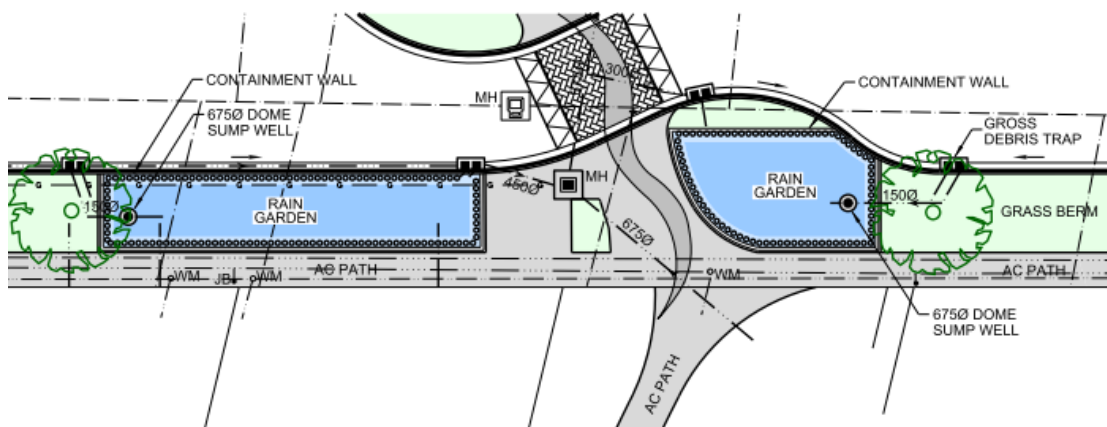

Figure 9 Example of a berm or build out rain garden

4.5 Overflows

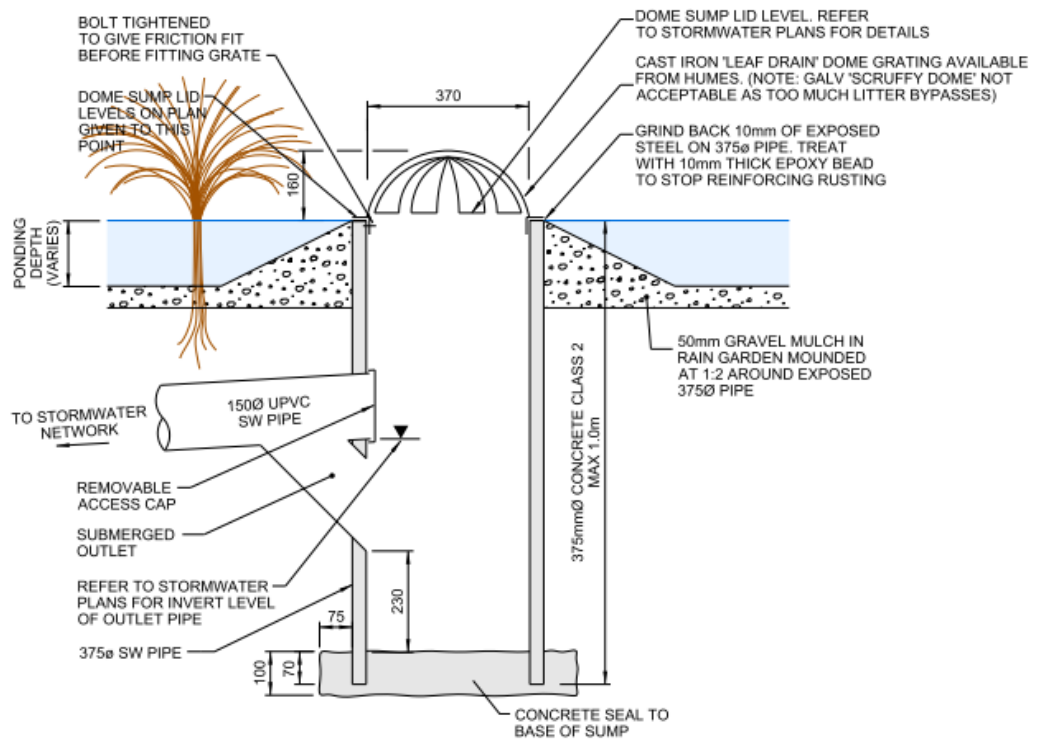

Figure 10 Dome sump overflow



Figure 11 Double sump on batter slope overflow

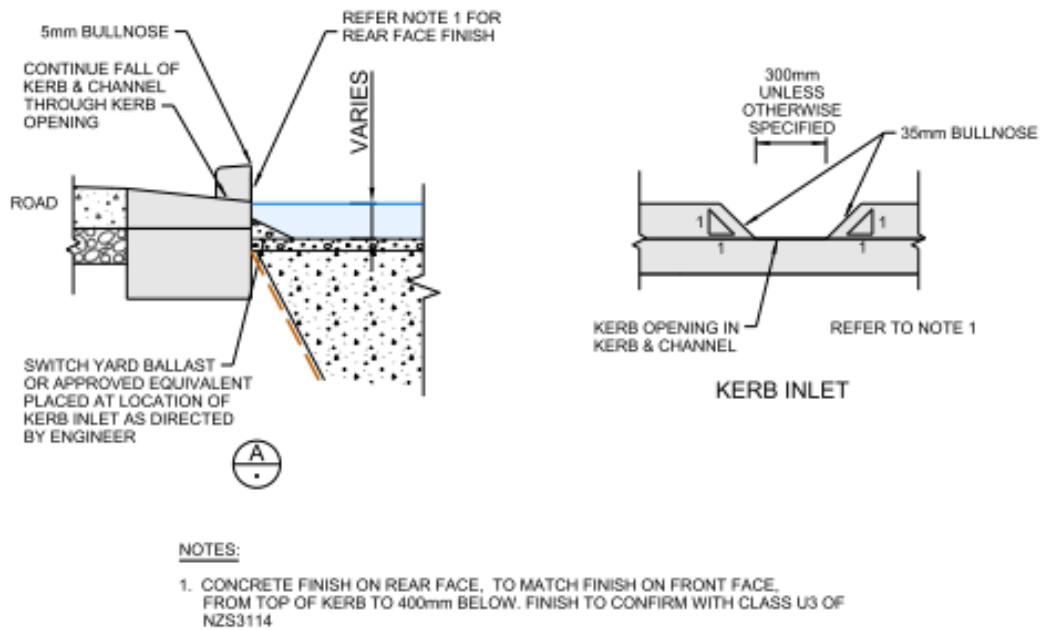

Figure 12 Dual function kerb exit overflow/entry

4.6 Inlets

A simple kerb opening entry is preferred with litter accumulating on the rain garden. However, if litter needs to be prevented from entering the rain garden one of the other inlets can be used.

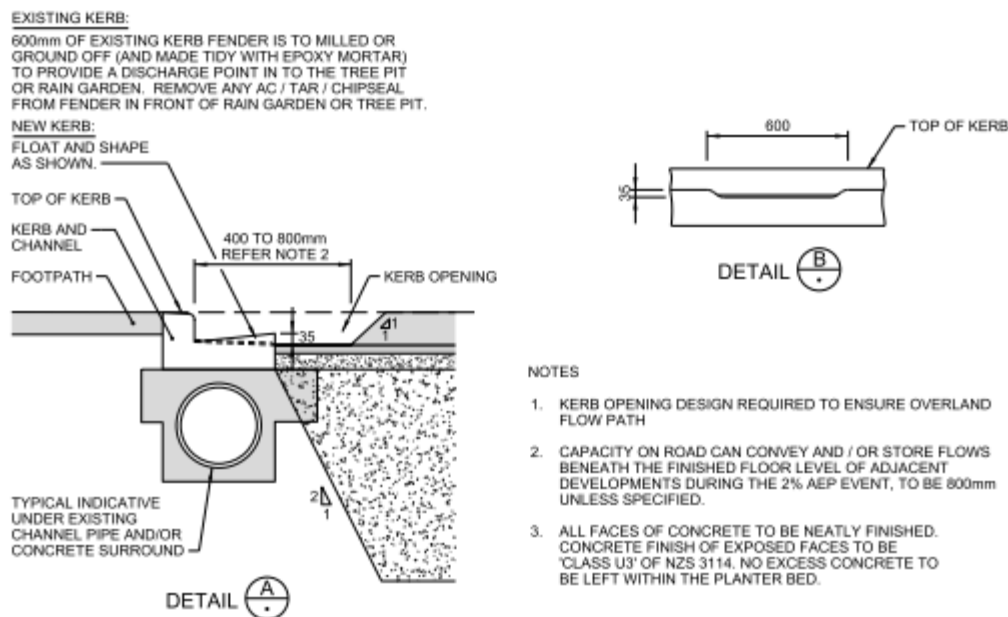

Figure 13 Fender discharge entry detail

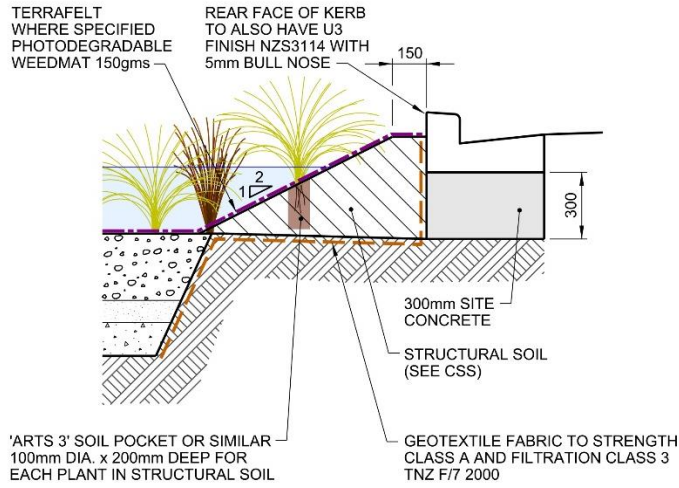
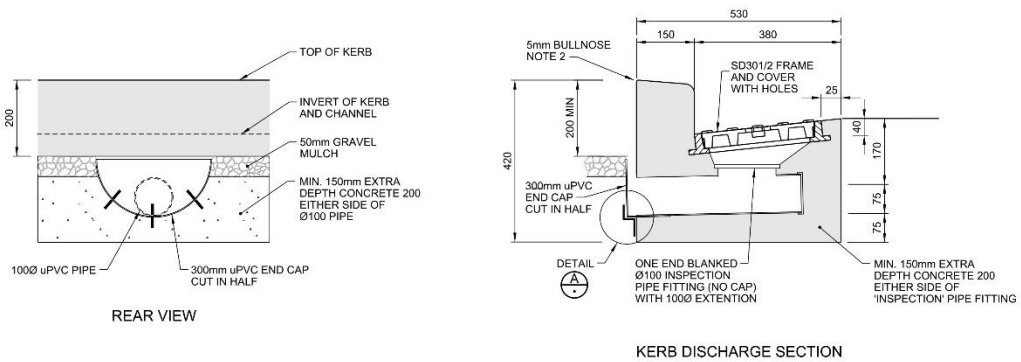

Figure 14 Rear sump entry



NOTES:

1. USE THIS DETAIL ONLY WHERE COLLECTING CATCHMENT LESS THAN 100m² AND THERE IS AN ADEQUATE SECONDARY FLOW PATH IF THE GRATE BLOCKS.

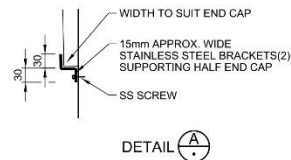

Figure 15 Rear sump entry (back of kerb filtered discharge)

Note: Use Figure 15 only when the contributing catchment is less than 100m² and an adequate secondary flow path is available if the grate blocks.

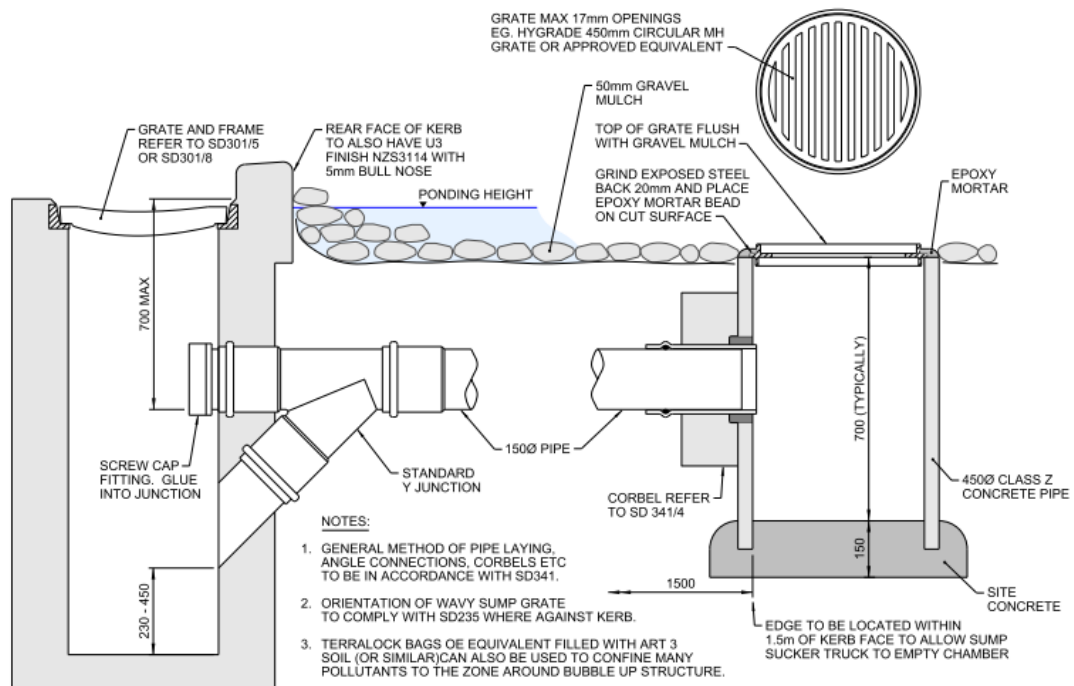

Figure 16 Rain garden inlet for filtered discharge (submerged bubble up acting as a gross debris trap)

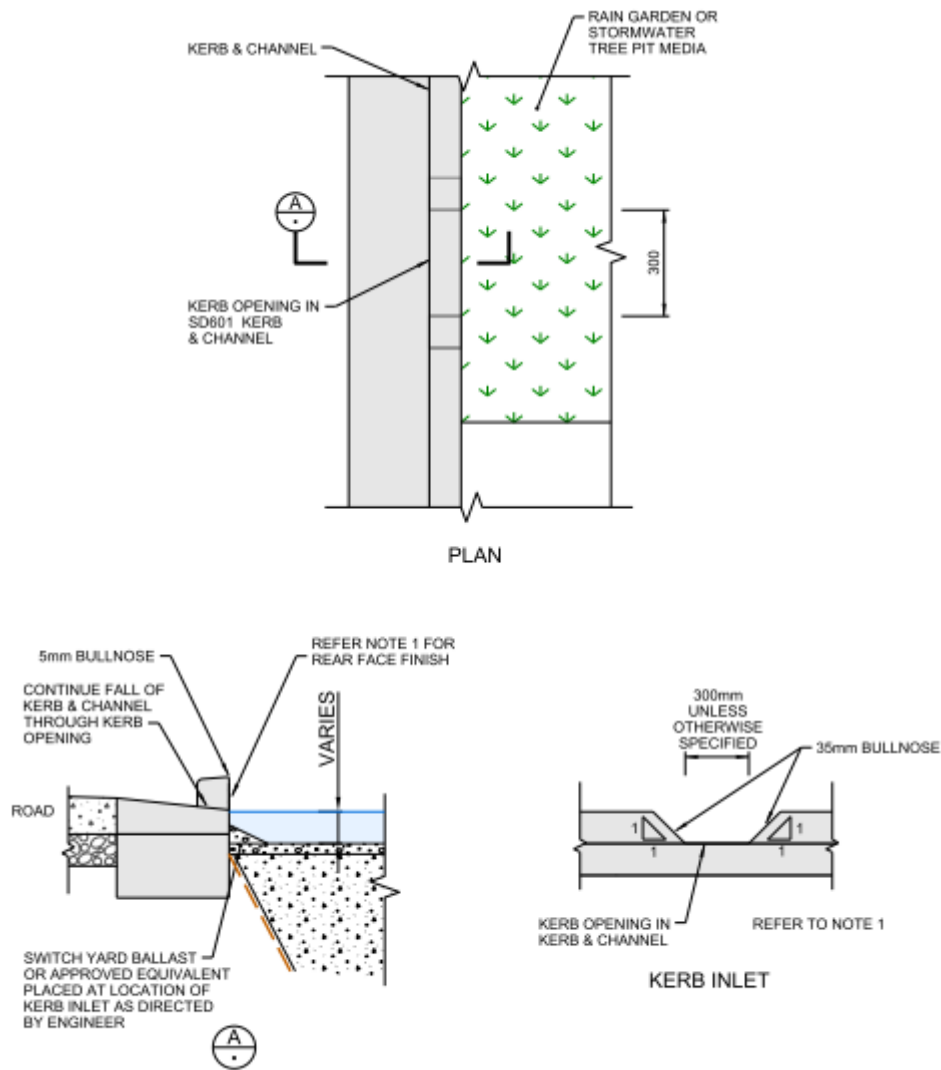

Figure 17 Back of kerb discharge

4.7 Sediment forebay

Sediment forebays are recommended in areas of high sediment load risk. Dimensions are dependent on cleaning frequency and anticipated sediment load.

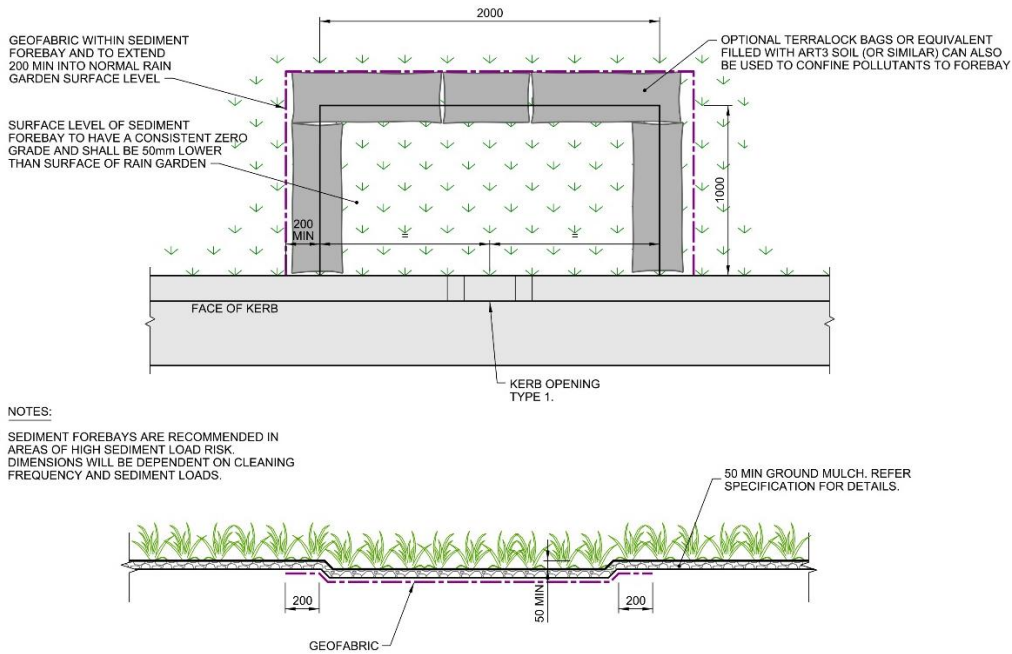

Figure 18 Sediment forebay

4.8 Edge support

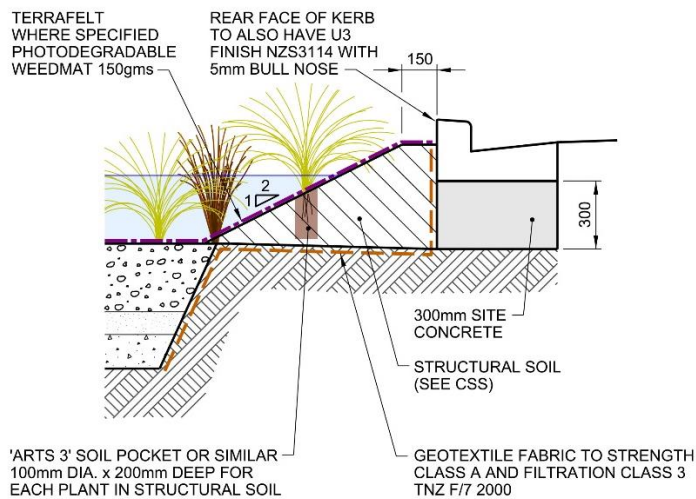

Figure 19 Standard edge support

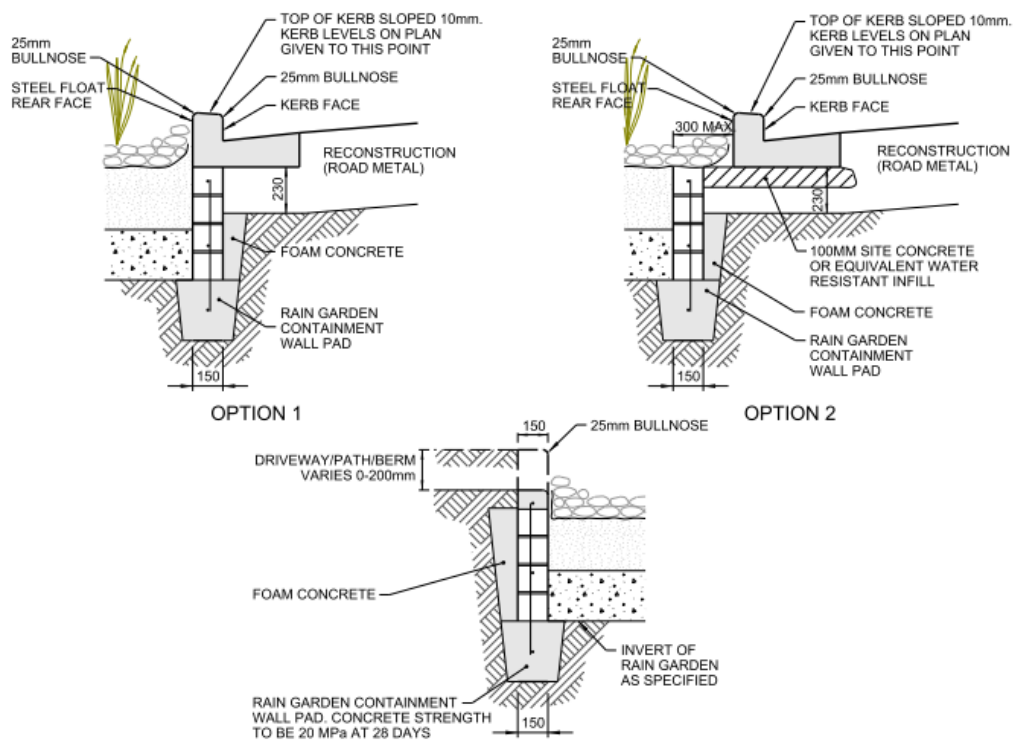

Figure 20 Edge support with a containment wall



Figure 21 Precast concrete walls allow for fast installation

4.9 Underdrain system

Where more than one collection pipe is required, the maximum spacing should be between 1.5 to 2 m between pipelines and 1 m from the outside edge of the rain garden.

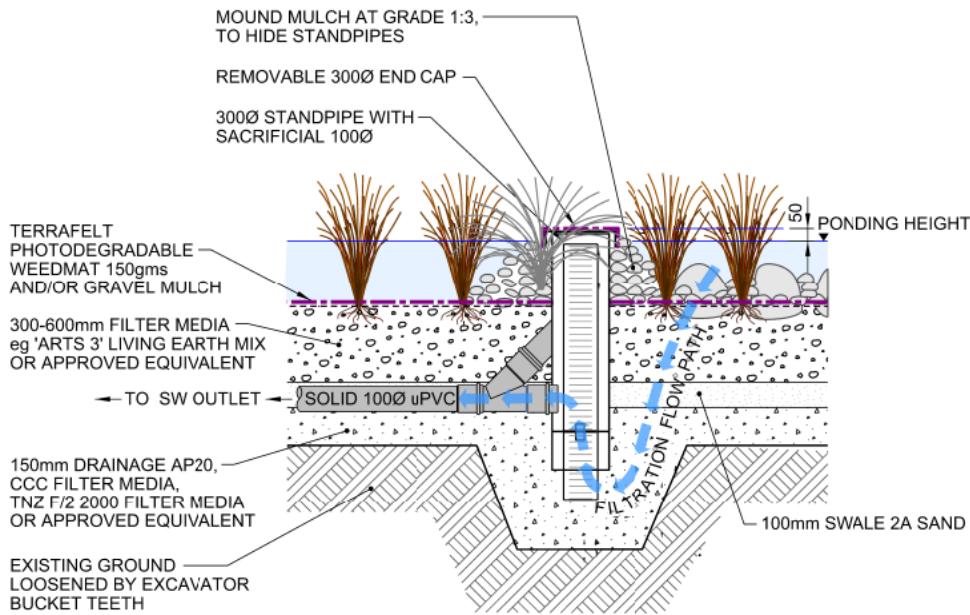

UNDER DRAIN SYSTEM FOR RAIN GARDENS CONTAINING TREES

Figure 22 Underdrain system for rain gardens containing trees (to prevent root intrusion)

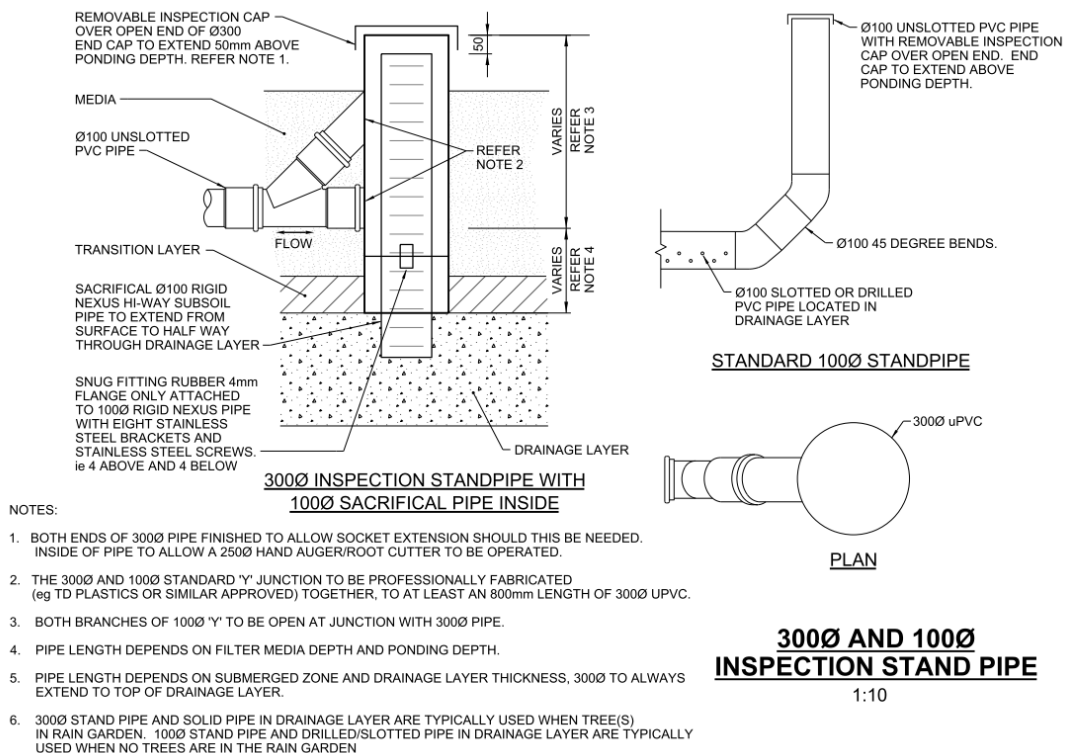

Figure 23 Inspection standpipe

4.10 Outlet Control

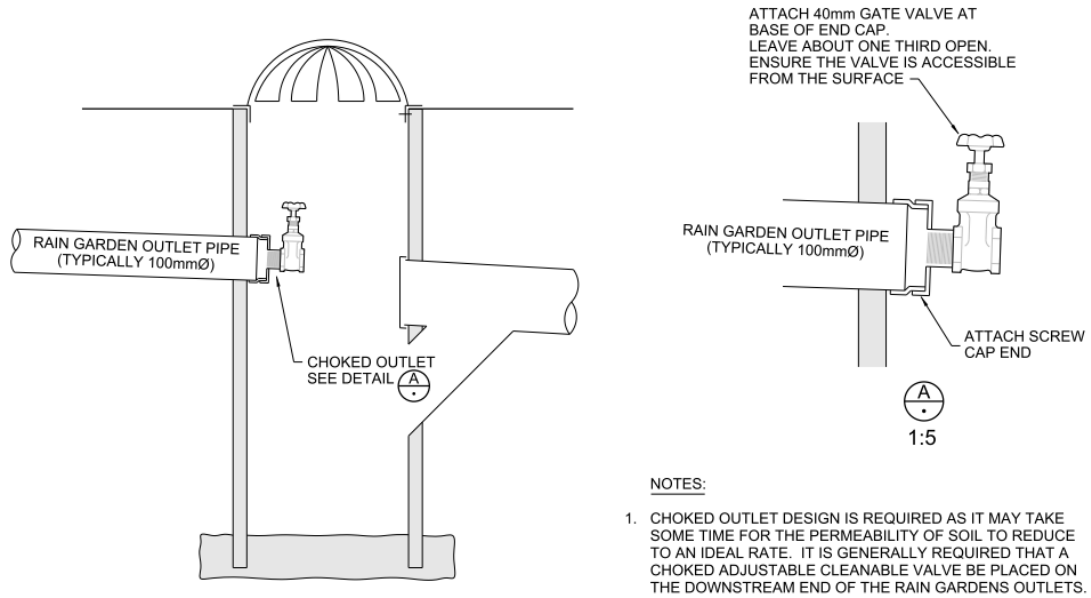

Figure 24 Choked pipe outlet control

4.11 Sample Engineering Drawings

Figure 25 Sample rain garden with no trees and discharging to a shallow stormwater outfall

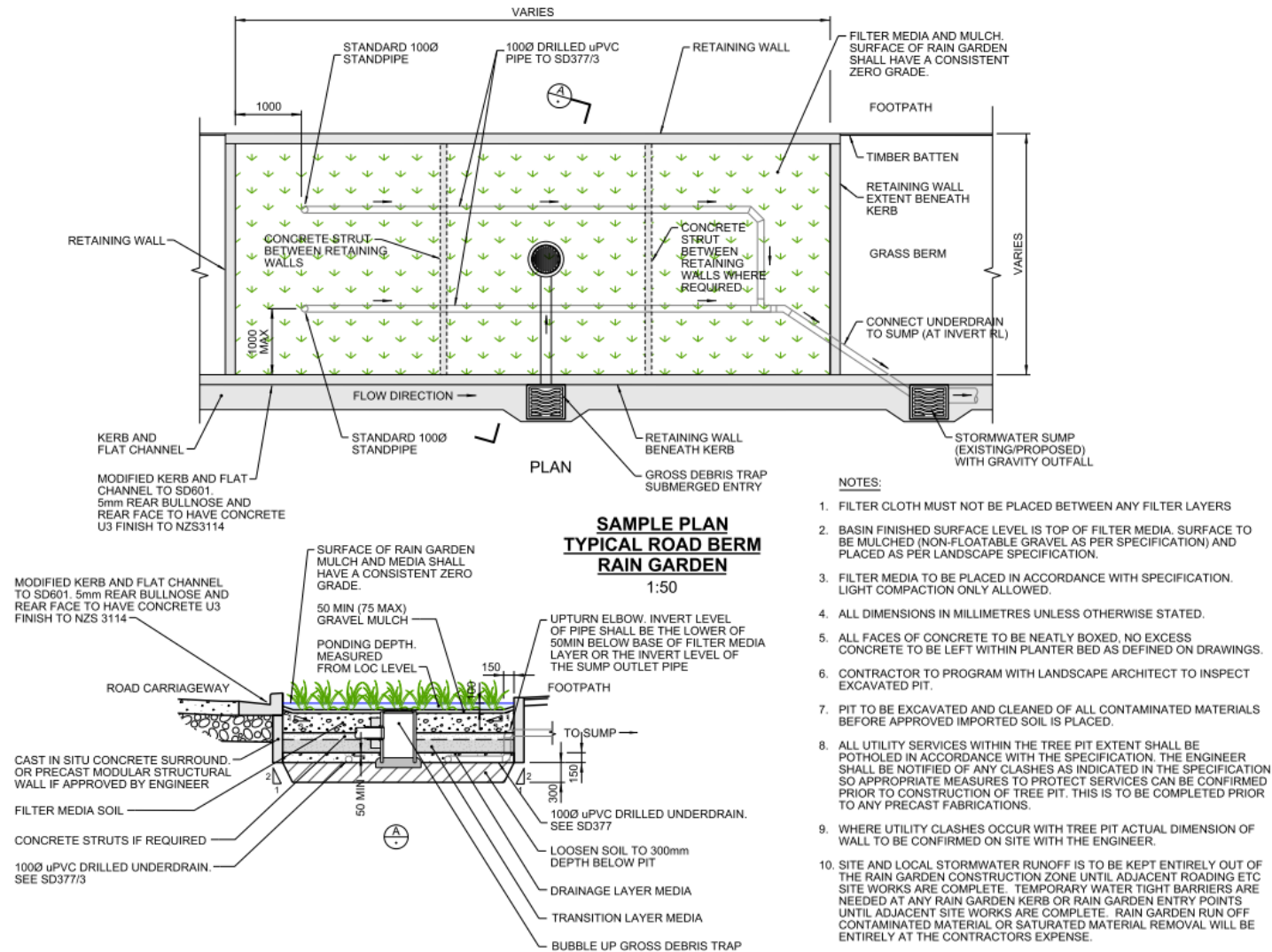
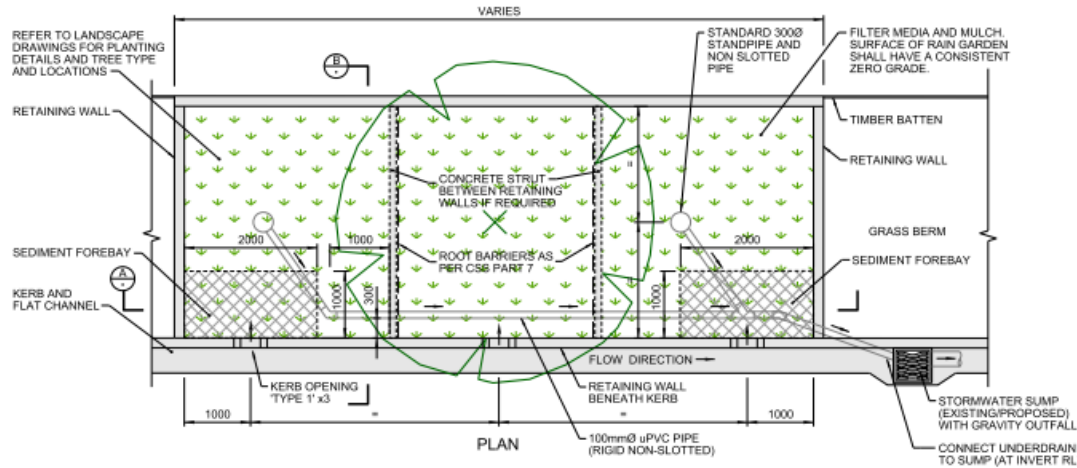
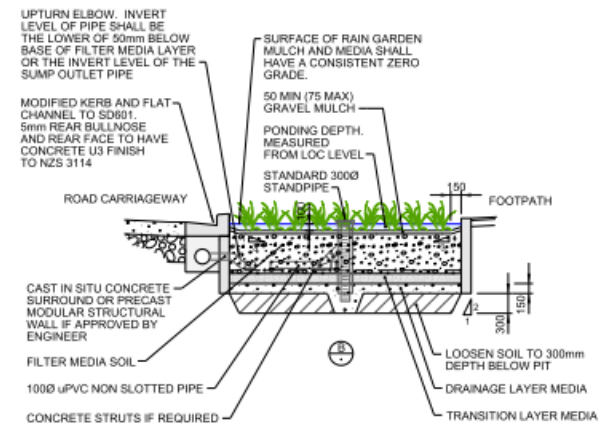
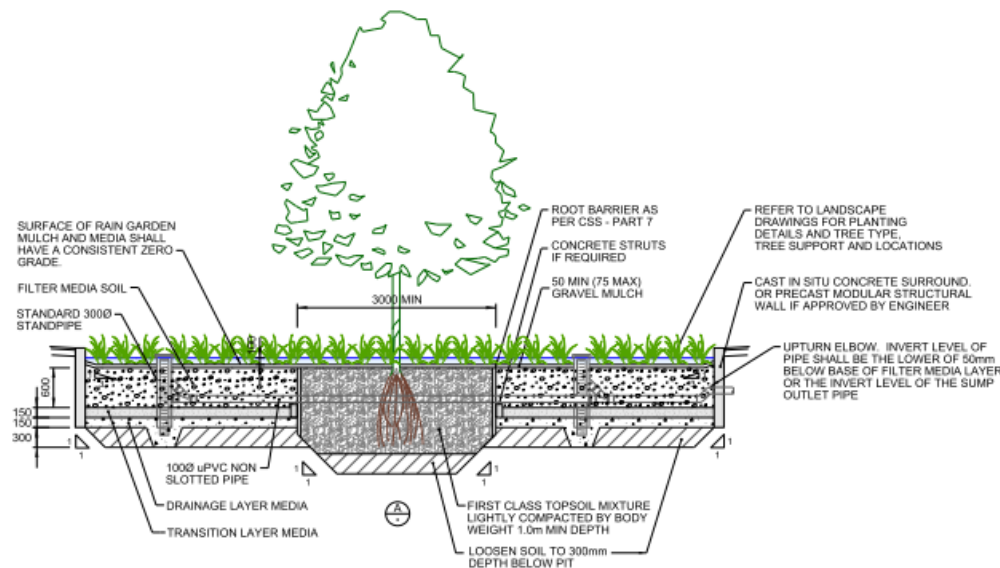

Figure 26 Sample rain garden with tree and discharging to a shallow stormwater outfall



NOTES:

1. FILTER CLOTH MUST NOT BE PLACED BETWEEN ANY FILTER LAYERS
2. BASIN FINISHED SURFACE LEVEL IS TOP OF FILTER MEDIA. SURFACE TO BE MULCHED (NON-FLOATABLE GRAVEL AS PER SPECIFICATION) AND PLACED AS PER LANDSCAPE SPECIFICATION.
3. FILTER MEDIA TO BE PLACED IN ACCORDANCE WITH SPECIFICATION. LIGHT COMPACTION ONLY ALLOWED.
4. ALL DIMENSIONS IN MILLIMETRES UNLESS OTHERWISE STATED.
5. ALL FACES OF CONCRETE TO BE NEATLY BOXED, NO EXCESS CONCRETE TO BE LEFT WITHIN PLANTER BED AS DEFINED ON DRAWINGS. CONCRETE TO HAVE EXPOSED U3 FINISH NZS3114.
6. CONTRACTOR TO PROGRAM WITH LANDSCAPE ARCHITECT TO INSPECT EXCAVATED PIT.
7. PIT TO BE EXCAVATED AND CLEANED OF ALL CONTAMINATED MATERIALS BEFORE APPROVED IMPORTED SOIL IS PLACED.
8. ALL TREES SHALL BE STAKED AS PER SD702 OR AS DETAILED.
9. TREE PIT TO BE INSPECTED PRIOR TO PLACING MEDIA.
10. ALL UTILITY SERVICES WITHIN THE TREE PIT EXTENT SHALL BE POTHOLED IN ACCORDANCE WITH THE SPECIFICATION. THE ENGINEER SHALL BE NOTIFIED OF ANY CLASHES AS INDICATED IN THE SPECIFICATION SO APPROPRIATE MEASURES TO PROTECT SERVICES CAN BE CONFIRMED PRIOR TO CONSTRUCTION OF TREE PIT. THIS IS TO BE COMPLETED PRIOR TO ANY PRECAST FABRICATIONS.
11. WHERE UTILITY CLASHES OCCUR WITH TREE PIT ACTUAL DIMENSION OF WALL TO BE CONFIRMED ON SITE WITH THE ENGINEER.
12. SITE AND LOCAL STORMWATER RUNOFF IS TO BE KEPT ENTIRELY OUT OF THE RAIN GARDEN CONSTRUCTION ZONE UNTIL ADJACENT ROADING ETC SITE WORKS ARE COMPLETE. TEMPORARY WATER TIGHT BARRIERS ARE NEEDED AT ANY RAIN GARDEN KERB OR RAIN GARDEN ENTRY POINTS UNTIL ADJACENT SITE WORKS ARE COMPLETE. RAIN GARDEN RUN OFF CONTAMINATED MATERIAL OR SATURATED MATERIAL REMOVAL WILL BE ENTIRELY AT THE CONTRACTORS EXPENSE.



5 Media selection

Full details for the media layers are given in the specification included in Appendix A. A brief description is given for each layer below.

5.1 Filter media

The most suitable filter media for Christchurch conditions is still in an early stage of development. The current approved filter media mix is ART3. ART3 is a proprietary mix developed by Living Earth that consists typically 50% coarse sand, 10% locally sourced topsoil and 40% compost material.

The use of topsoil should be kept to a minimum and most guidelines recommend a lower proportion of organic material than is in the ART3 mix. Many guidelines recommend against the use of compost as a source of organic material because it may contain contaminants.

As other materials are submitted for approval more mixes will become available.

5.2 Transition media

The sand layer shall be Swale 2A Sand in accordance with CSS Part 1.

5.3 Drainage media

CCC Drainage AP20 in accordance with CSS Part 1 has been used as the drainage media. Filter Medium CSS Part 1 32.16 is also suitable, but often hard to obtain in small quantities conforming to the specified grading curve. Another acceptable alternative is TNZ F/2 2000 Filter Media.

5.4 Mulch

Typically washed 20 mm dia. greywacke gravel rounds are used. The landscape architect specifies the type, size and colour of aggregate and whether it should be round or crushed after taking into account factors such as the risk to traffic and windows nearby.

5.5 Testing for contamination

The leachate from samples of the combined filter media material shall be tested using the Synthetic Precipitation Leaching Procedure (SPLP) to ensure that the stormwater contaminant concentrations listed in the stormwater discharge consent are not exceeded in the leachate. If the stormwater contaminant concentrations are not included in the stormwater discharge consent then these values must be obtained and approved prior to undertaking the SPLP testing.

5.6 Infiltration testing

Following construction, infiltration testing must be undertaken to confirm that the design infiltration rate has been achieved. This is detailed in Appendix A.

6 Plant selection

Plants selected for rain gardens in Christchurch need to be able to cope with the extremes of inundation and long dry periods in a free draining soil. The plants below have been specially selected as being able to meet these conditions.

Table 3 Recommended plants for rain gardens in Christchurch

Botanical name	Common name	Suitable conditions
<i>Apodasmia similis</i>	Oioi or jointed wire rush	All
<i>Astelia fragrans</i>	Kakaha	All but susceptible in over wet
<i>Blechnum montanum</i>	Mountain Kiokio	All but susceptible to frost
<i>Blechnum novae-zelandiae</i>	Kiokio	All but a bit frost tender
<i>Blechnum penna-marina</i>	Antarctic hard-fern	all
<i>Chionochoa flavicans</i>	Mini Toe Toe	All but susceptible to over wet
<i>Dianella turatu revoluta 'Little Rev'</i>	Dianella turatu	All
<i>Juncus edgariae</i>	Edgar's rush, or wiwi	All
<i>Libertia grandiflora</i>	Mikoikoi, NZ Iris	All
<i>Libertia ixioides</i>	Mikoikoi, NZ Iris	All
<i>Lobelia angulata</i>	Panakenake	All
<i>Phormium cookianum 'Emerald Green'</i>	Wharariki, NZ Mountain Flax	All
<i>Pimelea prostrata</i>	Pinatoro, NZ Daphne	All

Other possible plants not on the above list to be planted in areas maintained by Christchurch City Council will need to be assessed by the Council to ensure suitability for use in rain gardens and compatibility with existing maintenance regimes.

General planting tips

The following general guidelines should apply to planting:

- Choose appropriate plant species that can withstand prolonged periods of ponding and drought.
- Lay out plants randomly to suit soil depth, orientation of the plant bed, and overall site location. Ensure plants do not overhang pedestrian or movement corridors.
- Do not locate woody vegetation (scrub and trees) near inflow locations.
- Consider wind, sun and exposure when choosing varieties for planting.
- Do not plant noxious weeds.
- Aim for aesthetics and visual characteristics – it should look good.
- Consider traffic visual requirements (no tall plants in line-of-sight from a vehicle) and safety issues (refer to CCC Infrastructure Design Standards).
- Pay particular attention to watering plants as they establish because the use of free draining media requires that plants and trees need more frequent inspection and watering during the first two years. Once established, rain garden plants will not typically require watering.
- Plants placed near the inlet structure will receive more water and higher sediment loads so they need to be suitable in these growing conditions. Plants placed away from the inlet will receive less water and therefore need to be more drought tolerant.

7 Common design and construction issues

Table 4 Summary of Key Design and Construction Constraints

Constraint	Description of constraint	Solution
Existing shallow stormwater pipes	This impacts the depth of filter media that can be adopted and requires a modified design with a shallower extended detention depth (EDD) and filter media depth. In-situ ground conditions comprise poorly drained material that is not suitable for discharge to ground via infiltration/soak pits.	<p>The EDD can be reduced to allow shallow bioretention devices to be used (though this will increase the size of the device footprint).</p> <p>Stormwater tree pits can be designed with a submerged zone to allow connection to a stormwater pipe that is shallower than the depth of the tree pit media. Careful tree species selection is required to ensure it can tolerate these growing conditions.</p> <p>Shallow rain gardens can be designed with a reduced filter media depth to allow all bioretention device layers to fit between the kerb invert and shallow stormwater pipe invert levels.</p> <p>The use of shallow rain gardens with street trees incorporated into the rain garden footprint can also be used. This design allows increased ponding storage and passive irrigation benefits. In these devices the rain garden media and tree pit structural soil should be separated by an internal root barrier, and a 300 mm standpipe/subsoil pipe drainage system used rather than 100 mm standpipe or perforated subsoil pipes.</p>
Construction around existing underground services	Existing road carriageways (especially in the CBD) often have extensive existing services such as water reticulation, wastewater, stormwater, gas and multiple telecommunications cables. Project budgets often do not allow relocation of existing services so stormwater treatment devices need to be located between existing services, with adequate protection provided to prevent damage of services.	<p>A rectangular footprint can allow devices to be constructed between existing services adjacent the on-street parking bay.</p> <p>Relocation of kerb alignments can allow the location of tree pits and rain gardens to miss areas with extensive underground services.</p> <p>Some utility services can pass through rain gardens e.g. telecommunications, water, sewer and stormwater. Gas and electricity services generally should not pass through rain gardens (If they do, the maintenance manual must highlight their presence).</p>

Constraint	Description of constraint	Solution
Construction of treatment devices adjacent to road carriageways	Stormwater tree pits, rain gardens and the adjacent carriageway needed to be protected from damage.	<p>Where possible a battered edge should be adopted within stormwater tree pits and rain gardens to minimise the extent of retaining walls and reduce costs. Where there is not space for batters, vertical retaining walls can be used instead.</p> <p>Adjacent services, carriageway and footpath surfaces can be protected from root damage and saturated subgrade using retaining walls and root barriers. For stormwater tree pits, the inclusion of submerged zones and appropriate tree species selection will encourage tree roots to grow down rather than spread beneath the carriageway in search of water.</p>
Maintaining overland flow path capacity	As Christchurch is flat and street trees are generally in on-street parking bays, it is important to make sure that adjacent properties were not subjected to increased flooding vulnerability.	<p>This needs to be checked for each project, and any effects mitigated.</p> <p>Where possible stormwater tree pits and rain gardens should be located behind the kerb alignment which will allow high flows to bypass the device.</p> <p>Other solutions include grading the on-street parking bay carriageway towards a concrete dish drain that flows along the front of bioretention devices, and kerb openings upstream and downstream of passive irrigation tree pits constructed within standard on-street parking bays graded towards the kerb.</p>
High sediment loads during construction	Bioretention devices need to be protected from high construction sediment loads during construction	A combination of measures should be adopted to minimise the likelihood of filter media porosity being reduced from high sediment loads during construction such as the use of small sediment forebays, filter socks, and weed mats. Isolate construction zone runoff entirely from rain gardens.
Vehicle, cyclist and pedestrian safety	The design of stormwater tree pits and rain gardens needs to consider the safety of other all modes of transport within the transport corridor such as vehicles, cyclists and pedestrians.	A low EDD, battered edges and dense planting can be adopted to minimise the likelihood of injuries to pedestrians, cyclists and motorists where the pedestrian/traffic density indicates this may be an issue.

8 Stormwater tree pits

Stormwater tree pits are the preferred treatment device in locations where large trees are a feature of the streetscape. Areas such as the Central City, suburban centres, and some new business areas fit this criterion. For stormwater treatment function alone, rain gardens are likely to be preferred to tree pits as they will be cheaper. However, the marginal cost of a stormwater tree pit over a correctly sized conventional tree pit means they are economical where trees are planned to be installed for streetscape reasons.

A stormwater tree pit schematic is shown in Figure 27. Note, however, that the design of stormwater tree pits is still developing and a standard detail is still under development.

Stormwater tree pits come in many forms. Where the stormwater pipe network is deep enough or where a submerged outlet is installed tree pits can be connected to stormwater pipework in the street. Where the in-situ soil is pervious, tree pits can soak directly to ground. Even in circumstances where a stormwater treatment function is difficult, tree pits which are slightly depressed below the pavement surface can provide a passive irrigation function that both benefits tree health and reduces stormwater discharges (Figure 28 and Figure 29). If the underlying ground is of very low permeability, a 1% self-draining surface should be considered on the passive irrigation tree pit to minimise the risk of water logging.

In Christchurch, medium-sized trees will also be planted in large rain gardens for their amenity benefits. In the central city, a mix of stormwater tree pits and rain gardens will be needed to provide both desired streetscape amenity and desired level of stormwater treatment.

The design of stormwater tree pits is very dependent on the site constraints. A water quality volume based on a first flush rainfall depth of 20 mm should be provided if possible, but it is recognised that in some areas it is better to provide some treatment rather than none (e.g. a passive irrigation tree pit has benefits as long as the soil type, construction runoff and catchment size are considered). Design parameters are recommended in both the summary and detailed reports on Christchurch Stormwater Tree Pit Design Criteria (Stone, 2014).

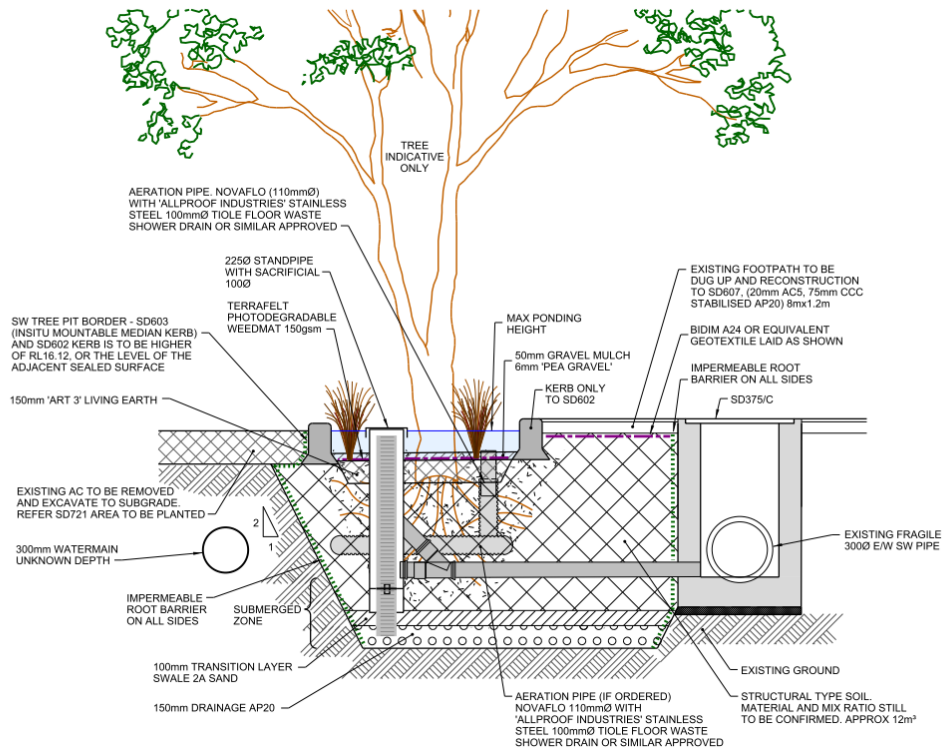

Figure 27 Stormwater tree pit schematic

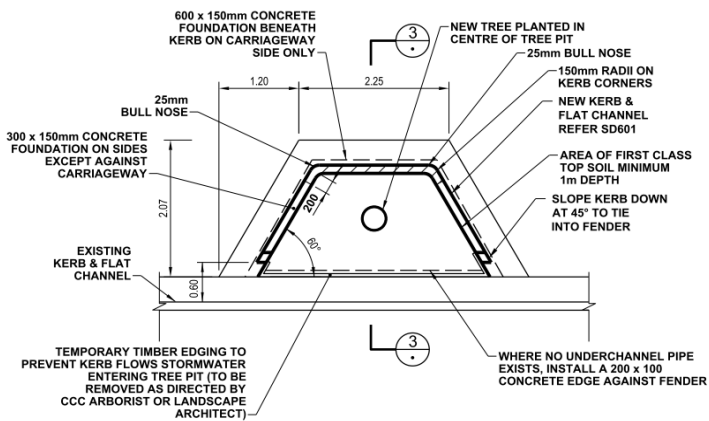

Figure 28 Passive irrigation tree pit plan

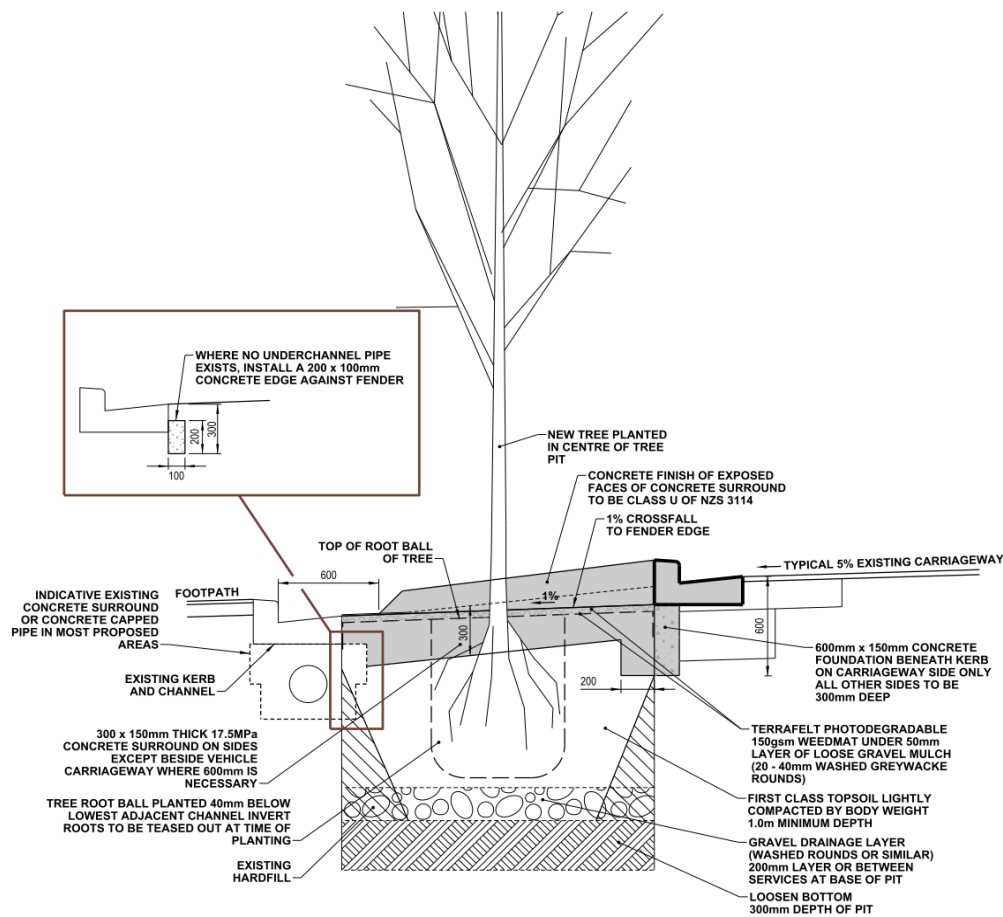

Figure 29 Passive irrigation tree pit cross-section (example only, section 3 fig 28)

There are a number of issues critical to the success of stormwater tree pits. The rain garden design procedures should be followed for tree pits, but special attention should be given to the following aspects:

Tree health Stormwater tree pits are designed for large specimen street trees with an expected life of 80 to 100 years. A soil volume of 3.5m x 3.5m x 1.5m (i.e. 18 m³) is recommended for optimal tree health. If the space available for soil is significantly less than this, smaller tree species should be used in rain gardens instead.

Tree species Suitable tree species are listed for wet and dry conditions in Stone (2014). A submerged zone will restrict the tree species that can be planted. Submerged

zones will be required in most areas within the city because the depth to the existing stormwater pipe network is shallow.

Location and layout

To treat the road reserve catchment only, the maximum spacing of pits along both sides of the road is 35m. The spacing should be no more than half this dimension if adjacent properties are also connected to the pits.

Standard drawings showing pits located both behind the kerb alignment and within on-street car parking bays are provided in Stone (2014). In all cases, the kerb and channel flow capacity must be maintained.

Existing services

The retrofitting of stormwater tree pits is constrained by existing services in the street. Some flexibility is required in location, layout and dimensions. In some circumstances, constraints will be so severe that rain gardens will need to be used rather than tree pits.

Extended detention depth (EDD)

An EDD of 150mm is recommended for tree pits in the CBD which can be reduced to a minimum depth of 100mm where the stormwater network is shallow. Where passive irrigation for tree health only is provided, the EDD can be reduced to 50mm or a 1% self-draining surface.

Media depth

A total media depth of 1.5m is recommended. To ensure tree health, the minimum filter media depth excluding the transition layer and submerged zone is 1.0m. The media depth includes a 150mm minimum depth gravel drainage layer in the bottom of the pit. A 300mm standpipe and connecting to the drainage layer with solid 100mm pipe will provide under-drainage if required.

Media clogging

Filter media must not be placed until after the road pavement and footpath has been constructed to avoid premature clogging of the media. The top 100mm depth of the media will need to be replaced each time the infiltration rate reduces below 20 mm/hr (i.e. once every 10 or more years).

Structural integrity

This can be an issue for stormwater tree pits constructed adjacent to road pavements. Solutions include a 2V:1H battered edge with a nib wall, confinement within a vertical concrete or block wall, or placing Council CSS structural soil in the pit.

Part B: Construction Guide

9 Construction sequence (with explanation for each)

Although individual design and sizes of rain gardens vary, they are generally constructed using a standard method.

The following outlines the sequence and key points for constructing a rain garden. On larger sites, rain garden construction may be detailed in construction plans and specifications.



Figure 30 Grove Rd rain garden during infiltration testing

9.1 Identify services and excavate

Confirm location and depth of services in rain garden excavation footprint.

Excavate the new rain garden to the depth shown on plans (typically 1.0-1.5m). Excavate with a toothed bucket to avoid smearing/sealing soil interface. Take care to avoid compacting the existing ground by not driving across or using heavy machinery in the area, as this reduces drainage capacity.

The soil beneath the rain garden should be loosened to a depth of at least 300 mm.

9.2 Form sides and lay liner (if required)

Construct edge walls as per design. Ensure site runoff diverted clear of excavation zone.

On poorly draining soils or where groundwater levels are high or in contaminated ground non-permeable liners may be specified on construction plans. The liner may need pinning to the walls of the rain garden. Lining is best avoided if possible. It reduces ground absorption opportunity, increases risk of poor plant health if pockets of water above liner do not drain and increases risk of mature trees blowing over in wind if roots cannot anchor adequately.

Geotextile in the base is not desirable as fines migration may blind fabric reducing soakage to ground.



Figure 31 Construct edge walls as specified. The soil below rain garden should be loosened with teeth on excavation bucket to 300mm below surface.

9.3 Install underdrainage

Install the underdrain system (if required) and connect to the piped stormwater system. The underdrain should typically be between 100 and 150mm in diameter and have a maximum slope of approximately 0.5% (5mm drop over 1 m length). A zero grade over short lengths is acceptable.

Underdrain pipe beneath the rain garden should be SN16 upvc and solid or drilled in accordance with sd377/3. The piped section outside the rain garden should not be drilled. Where trees are installed in a rain garden then the underdrain should not be drilled and an alternate solid pipe drainage system should be used in accordance with fig 23.

IMPORTANT – Make sure that the underdrain is connected to an approved stormwater collection and drainage system, and not to a wastewater (sanitary sewer) system.



Figure 32 Construct Overflow structures if needed. Ensure services are identified and protected appropriately.

9.4 Construct overflow drainage

Construct overflow drainage and connect to stormwater reticulation. Construct overflow to levels shown on plans (typically, just below the ground surface level but above the top level of the rain garden). If needed overflow pipes should be fitted with grates or screens to prevent clogging of pipes with litter or debris.

IMPORTANT - To create storage capacity in rain gardens, overflow drainage must be carefully constructed so level of the overflow match those specified in the construction plans.



Figure 33 Install appropriate under drainage system (example in photo will have trees installed).

9.5 Backfill underdrainage system

Carefully backfill underdrain with drainage material, usually gravel, with minimum of 50mm cover over underdrainage system. Total depth of the underdrain gravel layer (from the base of the rain garden to the top of the underdrain gravel) should be a minimum of 150 mm (Figure 34).



Figure 34 Place drainage layers and rain garden media from a low level and spread manually

IMPORTANT – Do not drop the gravel underdrain bedding material from height as this will damage the underdrainage system. Place gravel from a low level and spread manually. The surface of the gravel drainage layer media shall be constructed at a constant zero grade.

9.6 Install transition (sand) layer

If specified, install the sand layer as detailed on plans. Typically, a minimum of 100 mm depth to prevent movement of the soil mix into the underdrain. Use clean sand free of debris, fine sediments and clay. Level with a rake but do not compact.

Do not install a geofabric between separate rain garden layers.

The surface of the transition layer media shall be constructed at a constant zero grade.

9.7 Install rain garden media mix

Backfill with rain garden media mix. Rain garden media mix is critical to the performance of the rain garden. Rain gardens ideally require a 600 mm thick layer of rain garden media mix for the plants and for water quality treatment (Figure 34).

IMPORTANT - The use of topsoil in rain gardens should be kept to a minimum because infiltration rates vary and topsoil is prone to waterlogging.

Rain garden media mix is mixed specifically for rain gardens and is gradually becoming commercially available. Contact the Christchurch City Council for local approved suppliers. Rain garden media mix shall have an initial permeability of at least 50 mm/hr. A poor media mix will not allow the rain garden to function. Rain garden media mix shall be free of stones, stumps, roots, or other woody material over 25 mm in diameter and free of brush or seeds from noxious plants. **DO NOT** substitute a hand-mixed composition of clay, topsoil and sand. Place rain garden media mix in 150 mm layers and wet slightly to aid natural compaction. The treatment media shall be evenly and lightly consolidated (ie gently tamped with the back of a digger bucket) with each lift to reduce subsequent settlement. Do not install a geofabric between separate rain garden layers. The surface of the rain garden media shall be constructed at a constant zero grade.

9.8 Complete to finished level

Wet rain garden media and carefully excavate or fill to achieve finished level. The finished level should create the ponding area to below level of surround ground to prevent runoff bypassing rain garden (Figure 35).



Figure 35 Rain garden media contoured to form ponding area.

9.9 Planting

Plant as per design planting plan. If no plan is provided, refer to Section 6 for guidance on appropriate plant species and planting of rain gardens.

IMPORTANT – Do not use fertilisers, herbicides or pesticides as they may impact or pollute downstream water quality.

9.10 Place pebble mulch

Place washed pebble mulch to the required finished level (Figure 35). Determine whether a photodegradable weed mat is necessary because of significant silt plume risk. The mulch should be:

- Free of other materials such as weed seeds, soil, roots, etc.
- Applied to a minimum depth of 50 mm, maximum depth of 75 mm.

IMPORTANT - Mulch is not levelled off – mulch follows the general contour of the rain garden. Check the finished ponding level lies at depth specified below the overflow and surrounding ground as indicated on plans. Ponding levels are typically 300mm deep. This allows treatment before run off drains away.

9.11 Review levels

Review levels indicated on the plans. The rain garden typically requires a ponded area 300mm below the overflow and surrounding ground level. Install grass filter strip and/or kerb cuts if included.

Typically, kerb cuts are used alongside roads and in car parks. Kerb cuts must be 100mm min wide to allow sheet flow. Erosion prevention measures may be required at inflow points.

In some car parks, individual parking blocks are set 500mm back from the edge of the car park. Make sure a concrete strip at least 300mm wide is created between car park edge and rain garden to avoid loading the side of the rain garden.

9.12 Test the rain garden

Test the rain garden. If possible, inspect the bed after heavy rainfall, and monitor to check water level drains completely over 24 hours. If this is not possible, fill rain garden with reticulated water from a hydrant or nearby hose to a depth of approximately 200mm for testing over 24 hour period.

If the rain garden drains too fast, install a choke and/or adjust any valve fitted on the downstream end of the outlet.

9.13 Completion and tidy up

Complete surface treatment on adjacent areas. Remove erosion and sediment control devices such as silt fences and catch pit protection devices, particularly geotextile over sumps.

9.14 Other notes

Non permeable lining - Lining is best avoided if possible. It reduces ground absorption opportunity, increases risk of poor plant health if pockets of water above liner do not drain and increases risk of mature trees blowing over in wind if roots cannot anchor adequately.

Where non-permeable lining is specified for rain gardens the lining will typically extend along the base and side of the rain garden to prevent groundwater flows into the rain garden. Take care not to tear the lining when placing it. Ensure all seams, especially around pipes punching through the liner, are properly sealed to prevent groundwater from entering the underdrain.

Observation wells - Some rain garden designs include observation wells, which often look like capped riser pipes. Observation wells are used to monitor water depths in the rain garden. The 300 mm standpipes used for rain gardens with trees are also suitable observation wells. Discharge and overflow pipes may also have inspection and clean-out access points (usually capped) so underdrainage system can be inspected and back washed for maintenance or to remove blockages.

9.15 Quick checks

- ✓ Get approval from designer for all changes to original construction plans. Major changes need approval from the Council.
- ✓ Construct rain garden from bottom up with surrounding areas stabilised. Prevent soil and sediments generated from construction entering the rain garden.
- ✓ Set accurate heights for each element of the rain garden, particularly the underdrain, existing surrounding ground level and inflow and overflow mechanisms. Changes to levels may cause the rain garden to fail to operate as intended.
- ✓ Block or divert away any new or existing inlets and outlets or concentrated surface runoff from the rain garden.
- ✓ Check the media mix and other material composition is as specified in the design.

9.16 Things to avoid

- ✗ If possible, do not construct the rain garden until after surrounding areas have been stabilised and erosion is no longer a concern.

- ✘ Do not trench and backfill rain garden in parts.
- ✘ Do not compact the rain garden at any time. If possible allow time for natural settlement and compaction before planting.
- ✘ If not possible, consider dampening each layer of media mix during placement in rain garden.
- ✘ Do not drop gravel underdrain material from height as this will damage the underdrainage system. Place gravel from a low level and spread manually.
- ✘ Unless specified, do not use geotextile between the soil layers as this may cause clogging resulting in waterlogging for long periods. This reduces the stormwater filtration capacity and may stress and kill the plants.
- ✘ Do not use fertilisers, herbicides, pesticides.

Part C: Maintenance Guide

10 Rain garden maintenance

Rain gardens require a number of maintenance activities to ensure the effective long-term function of the system and plant health is maintained. Table 5 provides examples of common maintenance issues presented in the FAWB (2009) guidelines.







This guide outlines recommended inspection tasks, recommended frequencies and associated maintenance activities for rain garden devices. These inspection and maintenance tasks are presented in Table 6.

In addition to regular maintenance tasks outlined in the tables below, major maintenance and replacement will need to take place on a periodic basis. The frequency of these tasks will depend on how well the regular maintenance is undertaken, and on the sediment and other contaminant loads within the catchment. Possible major maintenance tasks and frequency may be:

- Removal and disposal of sediments (including replacement with new media) every 20 years
- Complete replanting every 20 years
- Major maintenance of drainage system, e.g. replacement of parts, every 10 years

Pay particular attention to watering plants as they establish because the use of free draining media requires that plants and trees need more frequent inspection and watering during the first two years. Once established, rain garden plants will not typically require watering.

Table 5 Example of Rain Garden Issues Requiring Maintenance

<p>Build-up of fine sediments on the surface of the filter media reduces surface porosity and treatment capacity.</p>		<p>Holes, erosion and scour should be repaired and inflow controls provided or augmented.</p>	
<p>Anthropogenic and organic litter build-up is unsightly and can hinder flow paths and infiltration.</p>		<p>Anthropogenic and organic litter build-up is unsightly and can hinder flow paths and infiltration.</p>	
<p>Poor plant growth can be a sign of too much or too little water, or of poor filter function.</p>		<p>Vegetation die off can be a sign of too much or too little water, or proof of poor filter function.</p>	
<p>Weeds are unsightly and can reduce treatment capacity.</p>		<p>Blocked overflow grates can result in nuisance flooding.</p>	
<p>Overfilling of filters reduces the extended detention storage and treatment capacity.</p>		<p>Overflow levels that are set too low reduces the extended detention storage and treatment capacity.</p>	

Source: Based on FAWB (2009).

Table 6 Inspection and Maintenance Tasks for Rain Gardens (Source: FAWB, 2009, adapted for Christchurch City Council)

Inspection Task	Frequency	Comment	Maintenance Action
FILTER MEDIA			
Check for sediment deposition	3 monthly, after rain	Blocking of inlets and filter media reduces treatment capacity.	Remove sediment from inlets, forebays and other pre-treatment measures, and the surface of rain gardens (NOTE: This sediment may be contaminated and therefore MUST BE disposed of at a secure landfill.)
Check for holes, erosion and scour	3 monthly, after rain	Holes, erosion and scour can be a sign of excessive inflow velocities due to poor inflow control or inadequate provision for bypass of high flows.	<ul style="list-style-type: none"> • Infill and holes, repair erosion and scour • Provide/augment energy dissipation (e.g. rocks and pebbles at inlet). • Reconfigure inlet to bypass high flows. • Relocate inlet.
Inspect for build-up of oily or clayey sediment on the surface of the filter media	3 monthly, after rain	Reduced surface porosity reduces treatment capacity.	Clear away and mulch on the surface and lightly rake over the surface of the filter media between plants.
Check for litter in and around treatment areas	3 monthly, after rain	Flow paths and infiltration through the filter media may be hindered.	<ul style="list-style-type: none"> • Remove rubbish, leaves and other debris from surrounding drainage area (NOTE: This litter may be contaminated and therefore MUST be disposed of at a secure landfill.)
HORTICULTURAL (NOTE: Do NOT add fertiliser to rain gardens and ONLY use pesticides or herbicides suitable for use near waterways)			
Assess plants for disease or pest infection	3 monthly, or as desired for aesthetics		<ul style="list-style-type: none"> • Treat or replace as necessary.
Check plants for signs of stunted growth or die off.	3 monthly, or as desired for aesthetics	Poor health can be a sign of too much or too little water, or poor flow control.	<ul style="list-style-type: none"> • Check inlet and overflow levels are correct and reset as required. <p>For too much water:</p> <ul style="list-style-type: none"> • Replace plants with species more tolerant of wet conditions. <p>OR</p> <ul style="list-style-type: none"> • Rejuvenate filter media to design infiltration capacity. <p>For too little water:</p> <ul style="list-style-type: none"> • Consider installing a choke on the outlet <p>OR</p> <p>Replant with species more tolerant of dry conditions.</p>
Check that original plant densities are maintained	3 monthly, or as desired for aesthetics	Plants are essential for pollutant removal and maintaining drainage capacity. Plants should be close enough that their roots touch each other; 6-10 plants /m ² is generally	Carry out infill planting as required – plants should be evenly spaced to help prevent scouring due to a concentration of flow.

Inspection Task	Frequency	Comment	Maintenance Action
		adequate. A high plant density also helps prevent ingress of weeds.	
Check for presence of weeds	3 monthly, or as desired for aesthetics	Weeds can reduce aesthetics and treatment capacity because some plants are more effective at pollutant removal than others.	<ul style="list-style-type: none"> Manually remove weeds where possible – where this is not feasible, spot spray weeds with a herbicide appropriate for use near waterways.
DRAINAGE			
Check that underdrain is not blocked with sediment or roots	Annually	Filter media and plants can become waterlogged if the underdrain is choked or blocked. Remove camera (CCTV) inspection of pipelines could be useful.	<ul style="list-style-type: none"> Clear underdrain as required using a pipe snake or water jet. Water jets should be used with care in perforated pipes.
Check that the water level in the submerged zone (if applicable) is at the design level.	Annually	Drawdown during dry periods is expected.	<ul style="list-style-type: none"> Check outflow level is correct and reset as required.
Check that inflow areas, weirs and grates over pits are clear of litter and debris and in good and safe condition.	Monthly, and occasionally after rain	A blocked grate or inlet would cause nuisance flooding.	<ul style="list-style-type: none"> Replace dislodged or damaged pit covers as required. Remove sediment from pits and entry sites (likely to be an irregular occurrence in mature catchments).
Observe rain garden system after a rainfall event to check drainage.	Annually	Ponding on the filter media surface for more than 24 hours after rain is a sign of poor drainage.	<ul style="list-style-type: none"> Check catchment land use and assess whether it has altered from design capacity (e.g. unusually high sediment loads may require installation of a sediment forebay).

11 References

Christchurch City Council (2003) *Waterways, Wetlands and Drainage Guide*, Christchurch City Council.

Christchurch City Council (2015) Rain garden sizing spreadsheet, Christchurch City Council, TRIM 15/1486825

Fassman, EA, Simcock, R, Wang, S, (2013) *Media specification for stormwater rain gardens, Prepared by Auckland UniServices for Auckland Council*. Auckland Council technical report, TR2013/011

FAWB (2009) *Guidelines for Filter Media in Biofiltration Systems (Version 3.01)* (pp. 1-8). Facility for Advanced Water Biofiltration Retrieved from <http://www.monash.edu.au/fawb/products/obtain.html>. accessed 2013

NZTA (2010) *Stormwater Treatment for Road Infrastructure*, New Zealand Transport Agency.

Stone, M. (2014) *Christchurch Stormwater Tree Pit Design Criteria: Detailed Report*. Capital Programme Group, Christchurch City Council. TRIM 14/215638.

Appendix A: Specification

12 General

This specification relates to the construction of a Rain Garden. This specification is additional to CSS.

All work is to be undertaken in accordance with the current version of CSS, unless explicitly varied below.

13 Abbreviations and definitions

The following definitions apply specifically to this section:

Rain Garden

Rain Gardens (or Bioretention Systems) are landscaped areas that collect and treat stormwater runoff. The stormwater is filtered as it passes through the layers of mulch, and then infiltrated into the ground as groundwater. If full infiltration is not possible, an underdrain system is required to carry treated water to a traditional storm water drainage system. During larger rainfall events, elevated sumps are provided to collect excess water.

14 Documents

Refer to CSS. The following documents are specifically referred to in this section:

- Stormwater Treatment for State Highway Infrastructure, NZTA. May 2010.
- ASTM F1815-06
- Melbourne Specification for Structural Soils
- NZBC B1/AS1 Structure
- NZBC E2/AS3 External moisture
- AS/NZS 2699 Built-in components for masonry
- NZS 3103 Sands for mortars and plasters
- NZS 3109 Concrete construction
- NZS 3121 Specification for water and aggregate for concrete
- NZS 4210 Masonry construction: Materials and workmanship
- NZS 4229 Concrete masonry buildings not requiring specific engineering design

- AS/NZS 4455.1 Masonry units, pavers, flags, and segmental retaining wall units - Masonry units
- AS/NZS 4671 Steel reinforcing materials
- CCANZ CP 01 Code of practice for weather tight concrete and concrete masonry construction

15 Requirements

15.1 Qualifications

Workers to be experienced, competent trades people familiar with the materials and techniques specified.

15.2 Acceptable product/material suppliers

Where a product or material supplier is named in this specification or on the contract drawings, the product/material must be provided by the named supplier. Where more than one named supplier, any one of the named suppliers will be acceptable.

Where a product is not specifically named, the Contractor shall submit a list of proposed products to the Engineer for approval. Where a proposed product is not on the Council's list of approved products it shall be specifically highlighted.

15.3 Substitutions

Substitutions may be made subject to the Engineers approval. The Contractor must provide sufficient evidence to demonstrate to the Engineer that the alternative proposed provides equal or better performance the product specified.

15.4 As built documents

Refer to IDS for the requirements for submission and review of as built documents and records.

Provide the following as built documents and records:

- Provide draft as built information prior to practical completion.
- Provide final as built information prior to the end of the defects liability period.
- Draft and final Operations and Maintenance Manual.

16 Products

16.1 Materials

16.1.1 Drainage pipe/ 300 and 100 mm stand pipe inspection points

Refer to CSS Part 3 for pipe work related to stormwater pipework, under-drains / sub-soil drains and drilling of perforations. All new 100mm solid walled stormwater pipework installed in the rain garden areas shall be rubber ring jointed SN16 PVC-u. 300mm pipe for the vertical Inspection Points 300mm Stand Pipes shall be SN16 PVC-u. '100m Y junctions' will be professionally fabricated to vertical 300mm pipe and constructed so that it is feasible to use a 200mm auger inside the 300mm IP in the future. Refer 'Details Sheet' for sacrificial vertical internal 100mm pipe.

16.1.2 Subsoil drains

Subsoil drains shall be SN16 PVC-u or similar approved. The pipe shall be either solid or drilled as per CSS SD 377/3 where indicated on the contract drawings.

16.1.3 Filter fabric

Where the use of 'geotextile', 'filter fabric' or 'filter cloth' is specified for rain gardens, it shall consist of a non-woven needle punched geo-textile filter fabric. Required strength class B or higher. Required filtration class 3 or better.

16.1.4 Sand

The sand layer shall be Swale 2A Sand in accordance with CSS Part 1.

The contractor may propose an alternate sand product for consideration by the Engineer if preferred. Any alternative proposed must be free from all fines <75 microns i.e. a quality controlled clean hard sand product from a consistent source, well graded and be accompanied with a grading curve provided by an accredited testing facility.

16.1.5 Drainage media

Drainage media shall be Christchurch City Council Drainage AP20 (in accordance with CSS Part 1), Christchurch City Council Filter Media (in accordance with CSS Part 1), TNZ F/2:2000 Filter material or an approved equivalent.

16.1.6 Treatment media

General

A treatment media layer is required to line the invert of the rain gardens.

The treatment media is intended to form a free draining soil that is reasonably resistant to compaction and capable of supporting appropriate plant life.

Two types of surface treatment media are proposed. These are referred to as:

- ART3 Mix— A proprietary mix developed by Living Earth that consists typically 50% coarse sand, 10% locally sourced topsoil and 40% compost material.
- Structural Soil

ART3 Mix

The ART3 mix shall be mixed and supplied by Living Earth from the Christchurch City Council composting facility in Bromley, Christchurch.

The Engineer reserves the right to request the Contractor change the media source or mixture should it be found to be unsatisfactory. Any costs associated with this shall be borne by the contractor.

Structural Soil

The most suitable structural soil mix for Christchurch conditions is still in an early stage of development. The best commonly available aggregate with an appropriate grading found so far is Switchyard Ballast. The Structural Soil specified currently in CSS1 is not suitable for rain gardens.

Structural Soil recently used in a RG was a thoroughly combined mix of Switchyard Ballast and filler soil mix in a ratio of 5:1 (by weight) that shall achieve a minimum CBR of 4% once compacted. This has been found to be too bony, too free draining and too hard to plant into and a new mix is still to be developed.

The media must achieve a minimum infiltration rate of 50mm/hr based on the ASTM F1815-06 method and a maximum rate of 150mm/hr once placed and meet the following criteria:

Filler Soil Mix

Use ART3 or alternative specified by engineer.

Aggregate

Shall be crushed angular greywacke or approved equivalent with at least two broken faces per stone.

The material must be angular in shape to form a locking matrix of stone. Smooth or rounded stone shall be rejected at the Contractors cost. Gravel shall be clean and free from clay, fines and other matter. The Contractor shall submit a sample to the Engineer for approval accompanied with a grading curve. The aggregate used shall be 'F&H Miners Rd- Switch Yard Ballast' and shall fall within the following particle size distribution.

A.S. SIEVE	PERCENT PASSING (%)
37.5	100-100
26.5	65-85
19.0	20-50
13.2	0-25
9.5	0-10
6.7	0-5
4.75	0

A sample of the structural soil mix proposed shall be provided to the Engineer for testing and approval. The Contractor shall provide test results from an accredited laboratory showing the proposed media meets 50mm/hr. infiltration rate based on the ASTM F1815-06 test, the proposed grading curve prior to placement.

The structural soil mix must be delivered to site pre-blended. The structural soil mix must be transported in a moist condition to prevent segregation of components.

The soil mix shall be placed in 150mm lifts and compacted to achieve a minimum CBR of 4%. The excavation must not be flooded or saturated when the soil mix is placed or compacted.

16.1.7 Mulch/Weed mat

Washed Stone Aggregate Mulch or an organic non-floating mulch, such as wool mulch or coconut coire matting is suitable.

If specified 'Photodegradable 150gsm weedmat' or coconut coire matting shall be installed over the treatment media. The permeability of weed mats must be taken into account. Many weed mats are unsuitable for rain gardens because their permeability under low head conditions is too low.

16.1.8 Boulders

As detailed on drawings.

16.1.9 Inlet and outlet sump structure

The inlet/ outlet grates shall be SD301/5 wavy type or SD301/8 if on a cycleway route. The use of galvanised gratings is discouraged because they export zinc into the water column.

17 Execution

17.1 Conditions

17.1.1 *Delivery, storage and handling*

Take delivery of materials and goods and store on site and protect from damage.

Move/handle goods in accordance with manufacturer's requirements.

Reject and replace goods that are damaged or will not provide the required finish.

Treatment media shall be stored on site such that the soil does not become saturated by rainfall, or compacted so that the moisture content and soil structure can be managed.

Structural soil whilst stored on site shall be stored in such a manner so that it remains moist, but does not become saturated or dry out.

17.2 Installation/application

17.2.1 *Erosion and Sediment Control*

Effective erosion and sediment control measures as described in the Erosion and Sediment Control Management Plan must be in place and the contributing catchment stabilised prior to the installation of rain garden filter media.

17.2.2 *Standards and tolerances*

Excavation Dimensions: +/- 100mm of specified plan dimensions. +/- 25mm of specified level.

Under drain location: +/- 100 mm of specified horizontal location unless otherwise authorised by the Engineer.

Grades: The under drain shall be installed flat and at a consistent level as shown on the contract drawings.

17.2.3 *Install rain garden*

The rain garden provides drainage of upstream kerb and channel through surface storage capture and soil infiltration. Good infiltration performance is key to their operation and it is therefore essential that the Contractor take care when excavating the rain gardens and placing the Treatment Media to avoid over compaction, smearing the excavation sides or 'blinding' the soil through poor site management. It is important that the Contractor does not allow construction run-off from surrounding earthworks to wash fines into the Treatment Media or the layers below.

To ensure the correct construction methodology is adopted for construction the rain garden shall be constructed and tested under supervision of the Engineer. Refer to the Section 'Completion – Inspection and Testing' for details.

Once the media is in place, no foot or vehicle track is to be permitted through or within the rain-garden other than for planting, mulching and maintenance. A continuous flexible barrier or tape fixed to warratahs shall be installed around the perimeter of the rain garden to discourage the public from walking over the soil and mulch. The barrier shall remain in place throughout the defects liability period. The Contractor shall allow for periodic inspection (at least monthly) and repair / reinstatement of the barrier as required.

17.2.4 Excavation for rain gardens/tree pits

Excavation for rain gardens shall not be carried out under unsuitable or wet soil conditions where trench sides are smearing thus creating impediment to seepage. A neat smooth finish is undesirable for rain garden operation as it provides a poor interface with the media.

A rough finish such as that achieved with a toothed digger bucket is preferred.

Excavated material shall be removed from the location of the rain garden and placed such that sediment from the stockpile material cannot re-enter the excavation.

Machinery or equipment shall not be used to remove excess excavated material during saturated soil moisture conditions. This operation shall be carried out in a manner to minimise damage to areas adjoining the trench and to minimise soil compaction.

The excavation shall be free of roots and projections or obstructions. Where over excavation has occurred, the bottom is to be brought back to grade using excavated material which is only lightly compacted in position to the same extent as the undisturbed surrounding soil. No loose soil shall be left in the excavation after grade restoration.

If groundwater is encountered in the excavation the Engineer shall advise the Contractor on how to proceed.

17.2.5 Geotextile filter cloth

Geotextile is not generally recommended or used in a rain garden especially not used on the base or in between rain garden treatment layers. In situations where the designer believes the use of filter fabric is appropriate on batters etc., the filter fabric shall be installed in accordance with the contract drawings and the manufacturer's recommendations so as to cover specified exposed faces of the excavation. Thoroughly and deeply scarify the excavated surface with a toothed backhoe before placing the filter cloth.

Geotextiles with low resistance to ultraviolet radiation (more than 30% strength loss at 500 hours exposure ASTM D-4355) should not be exposed to sunlight for more than 7 days. Geotextiles with higher resistance to ultraviolet degradation should not be exposed for more than 30 days.

17.2.6 Install drainage media

The drainage media (CCC Drainage AP20 (in accordance with CSS Part 1), CCC Filter Media (in accordance with CSS Part 1), TNZ F/2:2000 Filter material or an approved equivalent.) shall be carefully placed in the clean, excavated area after the excavated material has been removed and the excavation site cleared of potentially contaminating material and the excavation walls lined with filter cloth. Thoroughly and deeply scarify the excavated surface with a toothed backhoe before placing the Drainage Media.

The bedding zone shall be lightly and uniformly compacted. No mechanical compaction equipment shall be used. The drainage media shall not be placed or lightly compacted if the excavation is flooded or the in-situ soils saturated.

17.2.7 Install 100mm drainage pipes and stand pipes

The drains shall be located in accordance with this specification, the contract drawings.

The subsoil drain shall not be laid in flooded or saturated soils. Any perforated subsoil drain is not to be fitted with a filter sleeve. No perforated pipe is to be laid in rain gardens with tree pits.

The drains shall be installed parallel to and in contact with the bedding material prior to backfill placement. The under-drain shall not be laid where ponded water exists in the excavated trench. The Contractor shall place the drainage media carefully around and over the pipe to avoid damaging the pipe.

For Rain Gardens with no trees, each run of sub-soil drain shall start with a length of un-perforated pipe. This pipe shall be installed on a 45 degree angle to extend just above the finished level of the rain garden (allowing for mulch) and fitted with an injection moulded push cap for future maintenance access. Refer to the contract drawings. The cap must not be glued in place so as to allow future access. All pipework located outside of the drainage media shall be un-perforated.

The cap shall be located such that it is visible, but not protruding more than 100mm above the mulch.

Immediately before installation and jointing, the drain and fittings shall be inspected for defects, and any defective drain or fitting rejected. Backfilling shall not commence until the under drains have been inspected and accepted by the Engineer.

17.2.8 Install sand layer

Rain Gardens

A 100mm thick layer of Swale 2A Sand is to be placed on top of the Drainage Media unless specified otherwise on the contract drawings. The sand shall be placed in a single lift and left un-compacted. Compaction of the sand by running construction equipment over the top shall be strictly avoided. The sub soil drain shall not be crushed or disturbed during installation of the sand.

17.2.9 Install treatment media

All rain gardens are to be lined with a minimum 300mm thick layer of treatment media on top of the Swale 2A Sand layer.

The treatment media shall be placed to 50mm above the finished level shown on the Contract Drawings. The finished surface shall be reasonably smooth, uniform and free of obvious hollows and humps. Care shall be taken to avoid over-handling the soil.

The treatment media shall be evenly and lightly consolidated (i.e. gently tamped with the back of the digger bucket) with each lift to reduce subsequent settlement. The sub soil drain shall not be crushed or disturbed during installation of the treatment media.

The Contractor shall also take care to prevent the treatment media being blinded with sediment from construction run-off. The Contractor shall make good any blinding of the treatment media or over-compaction at the cost to the Contractor.

The treatment media shall not be placed or compacted if the moisture content exceeds 40%. Over compaction or poor handling (particularly if saturated) will result in a failed infiltration test, which in turn may result in additional cost to the contractor.

Once the media is placed the Contractor shall notify the Engineer. If the Engineer is satisfied with the soil placement he shall notify the Contractor that mulch and/or weed matt placement may commence. Mulching and/or weed matt installation shall be carried out within 10 working days, once approval is obtained from the Engineer to protect the soil.

17.2.10 Install structural soil

Where specified, the batters are to be lined with structural soil and the tree pits backfilled with structural soil, as detailed on drawings.

The structural soil shall be placed in lifts of 150mm and compacted to the finished level shown on the Contract Drawings. The finished surface shall be reasonably smooth, uniform and free of obvious hollows and humps. The compacted material shall achieve a minimum CBR of 4%.

The drainage pipes and sub soil drain shall not be crushed or disturbed during installation of the structural soil.

The Contractor shall take care to prevent the treatment media or sand layer below being blinded with sediment from construction run-off. The Contractor shall make good any blinding of the media with construction fines at the cost to the Contractor.

17.2.11 Existing services

The contractor shall be responsible for obtaining all relevant consents or authorities from the various utility owners and organising stand overs

Where services are encountered during the excavation of the rain gardens the contractor must provide temporary support to all services in accordance with the utility owner's requirements. Excavation method over existing services shall be in accordance with the utility owner's requirements / procedures for excavating over their asset.

Once the rain garden excavation is completed and all existing services have been exposed, the Contractor shall notify the Engineer in regards to what has been encountered. All services encountered which roots could penetrate or damage shall be wrapped in a 1.0mm thick flexible root management barrier. Root barrier joints or ends shall have a minimum 150mm lap. All root barrier joints shall be taped with a joining tape such as Root Barrier Super Adhesive Joining Tape or similar approved.

Bedding / haunching and pipe protection of existing services shall be in accordance with the utility owner's requirements. Pipe bedding must not be founded on ART3 treatment media. It shall be founded on compacted AP65 placed over the drainage media or, in the case of the tree pits, on compacted structural soil.

All services/non rain garden drainage pipe bedding / haunching and AP65 shall be entirely wrapped in filter cloth to prevent the migration of fines where not already wrapped with a flexible root management barrier. A layer of geo-grid shall be placed between the AP65 and the drainage media.

Where a service clashes with the rain garden's sub-soil drain or the utility owner's requirements for cover / protection cannot reasonably be met, the contractor shall notify the Engineer. The Engineer shall advise the contractor on how to proceed.

The alignment and level of the rain gardens sub-soil drain may be adjusted to avoid any service clashes, subject to approval from the Engineer.

Any pipe crossing vertically within 150mm of another pipe or concrete structure shall be separated with polystyrene packing, subject to approval from the utility owner.

The Contractor will be responsible for all damage incurred to services during construction and shall repair any damage at their own cost. Any repairs shall be carried out in accordance with the asset owner's requirements. As Building the location of previously unknown location services is necessary so that it can be included in the Maintenance Guidelines.

17.2.12 Place rain garden mulch

The rain garden and tree surrounds media shall be covered by 'Photodegradable 150gsm weed mat and small area of 50mm-75mm deep layer of gravel mulching for scour suppression. Protection of the ART3 media from compaction is critical. Refer to the contract drawings for details.

17.2.13 Connect to existing stormwater

Prior to installing the rain garden drainage pipes and Inspection Standpipes, the contractor shall excavate and expose the existing services.

The Engineer shall advise the Contractor on how to proceed and what, if any, design adjustments are required.

17.2.14 Cleaning

Carry out routine trade cleaning of this part of the work including periodic removal all debris, unused and temporary materials and elements from the site

17.2.15 Inspection

Immediately before installation and jointing, each drain and fittings shall be inspected for defects, and any defective drain or fitting rejected. The Engineer shall inspect the drainage media, sub-soil drain and filter cloth. If the engineer cannot inspect the construction, then the contractor shall take photos of the installation at each stage and provide them electronically to the engineer. Each photo shall be titled in a manner to identify the rain garden location and forwarded to the engineer within two working days. Backfilling with sand and treatment media shall not commence until approval for the under drain has been given by the engineer on the basis of a site inspection or review of digital photographs with sufficient detail.

17.2.16 Infiltration Testing

The rain garden shall be constructed under supervision of the engineer. Once the rain garden is constructed, an infiltration test shall be undertaken and witnessed by the engineer. In this test the rain garden is to be filled to a depth of 200mm and timed to drain over a maximum period of 4 hours.

Should the infiltration rate be less than 50mm/hr, further investigation or remediation may be requested by the Engineer in order to ensure the designed minimum infiltration rate required is achieved at the contractor's expense.

The engineer may request further infiltration tests be undertaken should the minimum infiltration rates not be achieved or should he have specific concerns relating to another rain garden other than those tested. All costs associated with a failed test shall be borne by the contractor.

17.2.17 Contamination testing

The contractor shall undertake testing of leachate from samples of the combined filter material using the Synthetic Precipitation Leaching Procedure (SPLP) to ensure that the stormwater contaminant concentrations listed in the stormwater discharge consent are not exceeded in the leachate. If stormwater contaminant concentrations are not included in the stormwater discharge consent then these values must be obtained from the stormwater engineer and approved by the Engineer prior to undertaking the SPLP testing.

A minimum of two samples shall be tested. If the location that the organic material in the filter media is sourced from changes and/or a different type of organic material is used during construction then the contractor shall undertake additional SPLP testing as requested by the engineer.

