

Grand National Stand - Conceptual Retrofit Scheme to 34%NBS

Design Features Report



DRAFT

Grand National Stand - Conceptual Retrofit Scheme to 34%NBS

Design Features Report

Client: Canterbury Jockey Club

Co No.: N/A

Prepared by

AECOM New Zealand Limited

Level 2, 2 Hazeldean Road, Addington, Christchurch 8024, P O Box 710, Christchurch MC, Christchurch 8140, New Zealand
T +64 3 966 6000 F +64 3 966 6001 www.aecom.com

22-Apr-2016

Job No.: 60439900

AECOM in Australia and New Zealand is certified to the latest version of ISO9001, ISO14001, AS/NZS4801 and OHSAS18001.

© AECOM New Zealand Limited (AECOM). All rights reserved.

AECOM has prepared this document for the sole use of the Client and for a specific purpose, each as expressly stated in the document. No other party should rely on this document without the prior written consent of AECOM. AECOM undertakes no duty, nor accepts any responsibility, to any third party who may rely upon or use this document. This document has been prepared based on the Client's description of its requirements and AECOM's experience, having regard to assumptions that AECOM can reasonably be expected to make in accordance with sound professional principles. AECOM may also have relied upon information provided by the Client and other third parties to prepare this document, some of which may not have been verified. Subject to the above conditions, this document may be transmitted, reproduced or disseminated only in its entirety.

DRAFT

Quality Information

Document Grand National Stand - Conceptual Retrofit Scheme to 34%NBS
 60439900

Ref \\nzchc1fp001\projects\604x\60439900\1.0 gns\5. draft docs\6.1 reports\03.11
 concept retrofit - dfr\16.04.21 canterbury jockey club concept retrofit dfr.docx

Date 22-Apr-2016

Prepared by Nik Richter, Matthew Crake

Reviewed by Craig Oldfield

Revision History

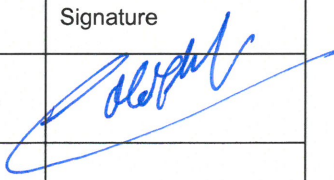
Revision	Revision Date	Details	Authorised	
			Name/Position	Signature
	22-Apr-2016	Draft	Craig Oldfield Associate Director - Structures	

DRAFT

Table of Contents

1.0	General	1
	1.1 Objective	1
	1.2 Scope	1
	1.3 Related reports	1
2.0	Retrofit Design Philosophy	2
	2.1 Existing Capacity	2
	2.2 Shear Failure Remediation	3
	2.3 Retrofit Solution	3
3.0	Seismic parameters	6
	3.1 Seismic Response	6
	3.2 Seismic Demand	7
4.0	Analysis Methodology	8
5.0	Structural Model	9
	5.1 Modelling	9
	5.2 Analysis Results	10
Appendix A		A
	ETABS Structural Models	A
Appendix B		B
	Non-linear Pushover Curves	B

DRAFT

1.0 General

1.1 Objective

This Design Features Report (DFR) incorporates AECOM's conceptual retrofit scheme to 34%NBS for the Grand National Stand (GNS). It provides commentary on the following matters:

- retrofit design philosophy,
- methodology of analysis,
- structural modelling assumptions,
- material properties for retrofitted elements.

1.2 Scope

The scope of this report was broadly defined in AECOM's Project Change Record 18 (PCR18) dated 29 March 2016. In general terms, the scope of work included:

- Undertaking reviews and completing seismic calculations:
 - o Reviewing current S&T architectural drawings of GNS,
 - o Performing hand calculations for a conceptual retrofit scheme. To ensure the removal of earthquake proneness, ensuring that a reliable load paths are established.
- Attending Contactor, Architect & QS meeting(s):
 - o AECOM will regularly meet with the Contractor, Architect & QS to discuss high level concept design progress and include "value adds" from the Contractor, QS and Architect. This meeting will address the practicality of installing the concept solution and may result in changes to the design as the concept develops.
- Production of hand "mark ups" of the existing drawings:
 - o The current S&T architectural drawings shall be "red lined" to communicate the proposed concept solution. These sketches shall contain sufficient detail (as per the NZCIC guidelines) for QS costing purposes,
- Production of a "design features" report.

1.3 Related reports

This report should be read in conjunction with the following reports:

- AECOM's Damage Assessment Report (DAR) of the Grand National Stand, dated 14th July 2015,
- AECOM's Detailed Damage Evaluation (DDE) of the Grand National Stand, dated 27 January 2016,
- AECOM's Design Features Report (DDE-DFR), dated 22 January 2016.

Refer to the DDE-DFR for:

- building description,
- soil conditions,
- existing material properties,
- existing cross sections and
- structural geometry.

DRAFT

2.0 Retrofit Design Philosophy

The premise of the conceptual retrofit scheme can be described in the following steps:

- Identify the residual capacity of the building that could be reliably accounted for in the retrofit strategy,
- Identify the structural members which exhibit premature shear failure and provide remedial details to suppress this mode of failure,
- Provide a reliable load path with a new structural system with minimum disruption to the existing structural systems and architectural features,

AECOM estimated and reported on the pre and post-earthquake capacity of the building in the DDE report. The report also notes that this capacity assessment is based on a number of potentially non-conservative assumptions, and that an optimistic position was taken by AECOM on matters relating to bond, slip behaviour, adequacy of lap lengths, splices of embedded steel section and adequacy of confinement of reinforcement and concrete strengths. As a result the assessment of this capacity bears a relatively high degree of uncertainty which is considered to be satisfactory for the assessment process but is not considered appropriate for a retrofit design. The retrofit design in our opinion requires a high level of certainty and a sound, rational engineering basis, equivalent to the one used on new-build structures.

For the Grand National Stand (GNS) the traditional reinforced concrete theory cannot be used as it relies on spacing of stirrups to provide confinement to the beams, columns and beam column joints. The confinement holds the core concrete and reinforcement in place which allows for ductility to be used. Intrusive investigations previously conducted have highlighted the variability and lack of stirrups. This means the capacity or tenacity of the existing structure is significantly reduced when subjected to a multiple-cycle event (e.g. seismic).

Refer to section 2.1 for details on how the existing capacity was accounted for in the retrofit design.

The second step in the retrofit design was to identify and remedy the buildings elements which were failing in shear and restricting the displacement capacity of the building. These elements include the lift core connection to the main building as well as spandrel beams and infill walls which showed brittle response.

Refer to section 2.2 for more details on how shear failure was addressed in the retrofit scheme.

The third step involved a provision of a reliable load path for the building in two orthogonal directions. It should be noted that the GNS is predominantly a gravity structure with no apparent lateral load paths, as expected from a structure designed and constructed in 1920's, long before seismic provisions were in place. Therefore, the principle of the retrofit design is to introduce a number of reinforced concrete super-frames in the transverse and longitudinal directions to establish a dependable load path that would cater for seismic events.

Refer to section 2.3 for more details on the retrofit solution.

2.1 Existing Capacity

Table 1: Residual capacity of elements and reduced demand

Element	Capacity
Demand	15.7 MN
Beam column connection	0.7 MN (not engaging)
Columns	2.2 MN (engaging)
Demand – existing capacity	13.5 MN

There is residual capacity of the existing beams column connection which is equivalent to approximately 700 kNbase shear. When compared to the demand of 15.7 MN this is considered negligible the retrofit scheme will not engage this capacity.

Retrofitting the beam column joint to resist the seismic demand would entail mobilising the full capacity of the encased steel beam. If every beam column joint in the transverse direction is retrofitted to mobilise the steel beam it would provide approximately half the resistance required. The retrofit scheme will not be engaging the beam column joint.

DRAFT

The building can rely on the moment capacity of the existing columns under dead load. There are 42 columns with approximately 1000kN of dead load and a moment capacity of 400kNm. This provides approximately 2.2MN of equivalent base shear or a moment of 24 MNm.

Therefore the new lateral restraining system has to resist a base shear of 13.5 MN or 149 MNm overturning moment in each direction.

2.2 Shear Failure Remediation

2.2.1 Lift Core

The beams connecting the lift core to the main structure are vulnerable to shear failures and they have to provide restraint to the top of the lift core which acts as a cantilever.

The top of the lift core is of concrete construction and adds a significant mass to be restrained. To restrain the core, drag bars are to be installed. There are to be two on each side at each level (16 in total) that wrap around into the main area. The drag bars primarily resist loads in the north south direction and in the east west direction carbon fibre strips are to be installed on the diagonal from the lift core into the main structure. There is to be three on each angle (six per floor, 24 in total).

2.2.2 Infill Walls

There are two infill walls that create a shear failure in the adjacent column by inducing short column effects. The walls are to be disconnected from the column by cutting a slot between them. For the wall on Grid C 14/15 the slots are to be filled with mastic but the wall on Grid C 19/20 to have brackets installed to provide out of plane resistance as well as mastic installed in the slot.

2.3 Retrofit Solution

The capacity is largely derived by available mass holding the building down.

Beams in the transverse direction have inherent ductility due to the encased steel beams but are limited by the dependability of the beam column joint. If the plastic hinge region of the beam can be moved from the joint to somewhere in the beam the ductility and moment capacity of the encased steel beam can be used. Therefore the column is extended around the existing beam to develop the plastic hinge in the full beam section.

The remaining resistance comes from the moment capacity at the base of the columns, therefore the columns have been retrofitted to be able to provide the resistance.

The strength and reinforcement of the diaphragm is unknown so six frames in the transverse direction have been retrofitted to limit the distance the diaphragm has to span.

In the longitudinal direction, wing walls at the retrofitted columns provide the added moment capacity at the base. There are no encased steel beams in the longitudinal direction and the existing reinforcement is unpredictable, therefore new beams connecting the wing walls have been created.

By creating T shaped foundation and column sections at each end it allows for the frame end in uplift to mobilise the contributing mass from the adjacent columns to resist the uplift force. Grid line 1 and 21 provide less mass than internal guidelines so are not be able to resist the seismic forces to the same extent as internal frames.

The existing columns that are to be retrofitted are to be scabbled back so that only the core remains. Keeping the core will reduce the amount of propping required and aid in the constructability of the retrofit scheme. The sides that are to be cast against should be scabbled to increase interlock between the sections.

By increasing the section of the columns from a square core to a T shape there will be a transfer of shear and axial forces between the existing core and new sections. It was initially considered to epoxy dowels to transfer the forces but the extent of drilling and epoxying made this impractical. It was instead chosen to post tension the sections together, this is also more reliable than epoxied connections.

In the transverse direction the new frame acts similar to two walls connected by beams. This induces large deflections at the top and large rotations in the top beam. To reduce the demands on the columns the top encased steel beam is to be removed and replaced with a new reinforced concrete beam.

Due to the large diameter and amount of reinforcement required in the retrofitted elements the bars are going to have to be coupled rather than lapped. The location of couplers will also need to be staggered up the building.

Refer to Figure 1, Figure 2 and Figure 3 for graphical representations of the retrofit scheme

DRAFT

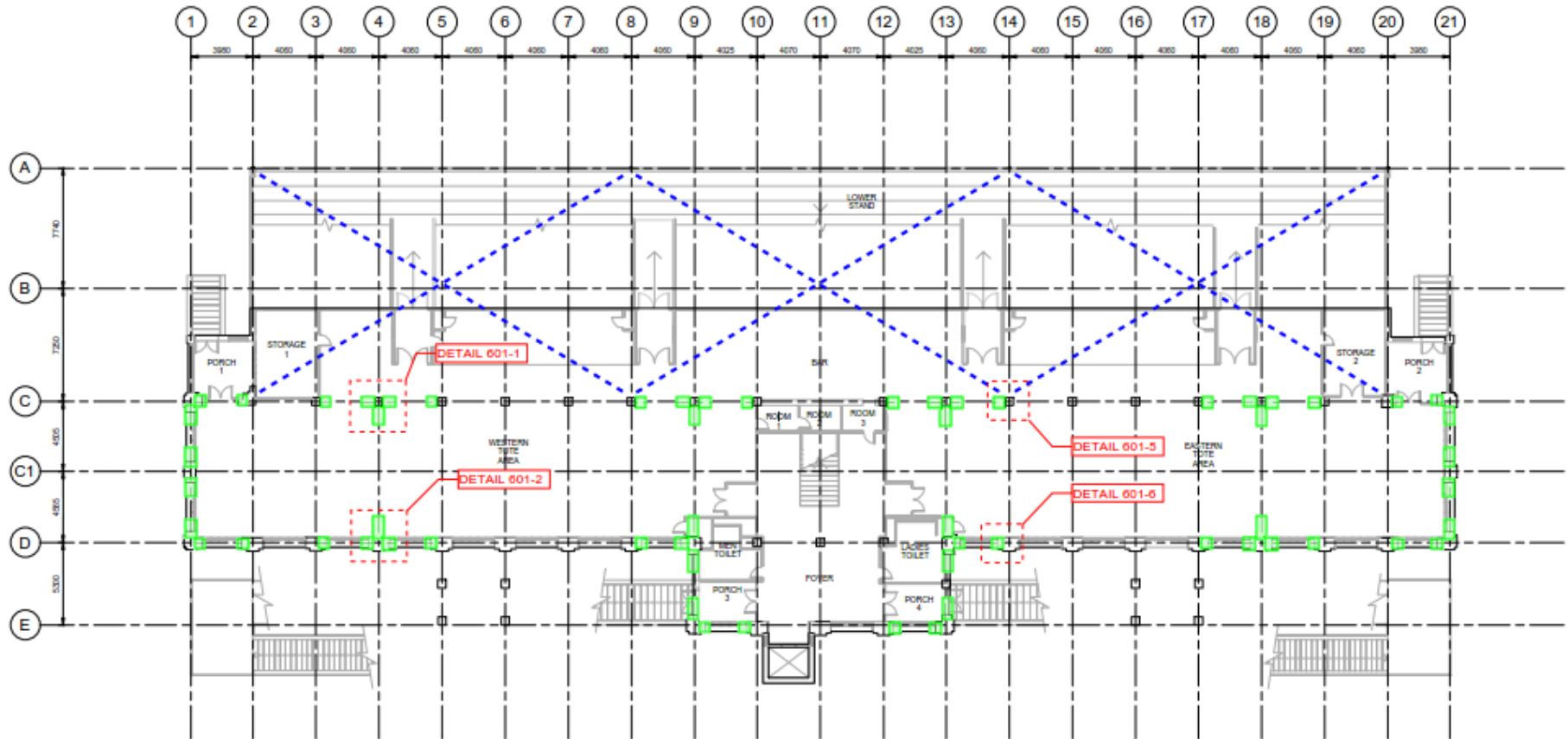

Figure 1: Layout of conceptual retrofit scheme

DRAFT

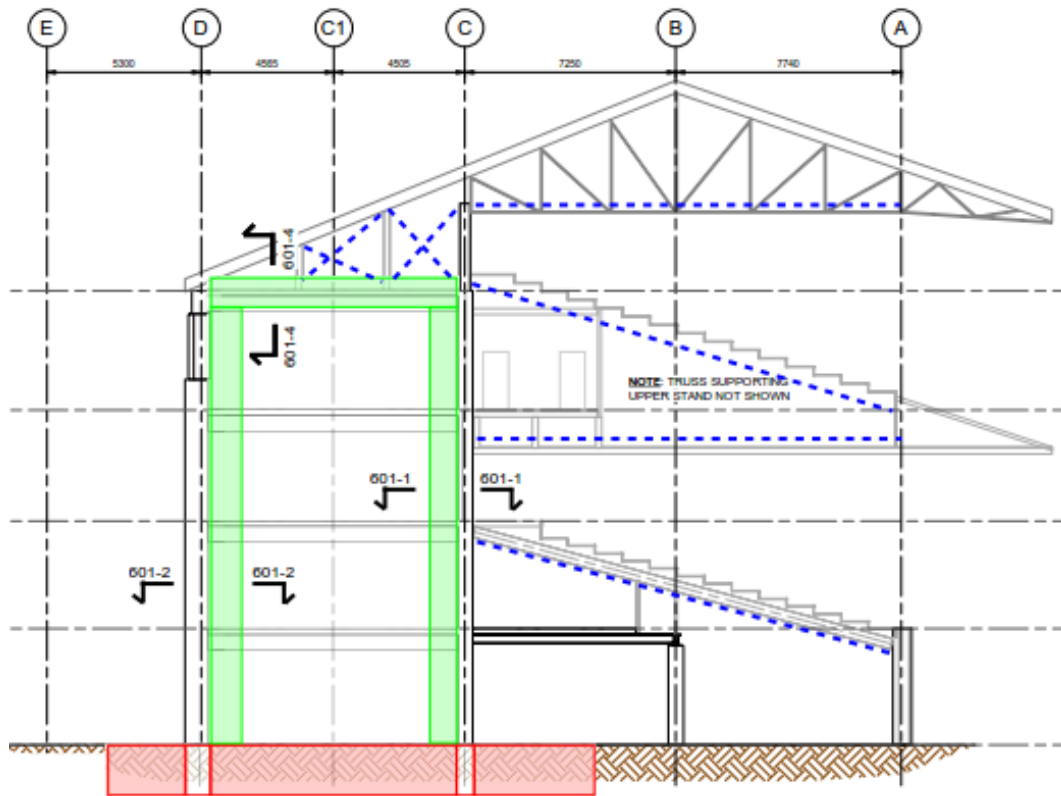

Figure 2: Grid 4 and 13 section showing conceptual retrofit scheme

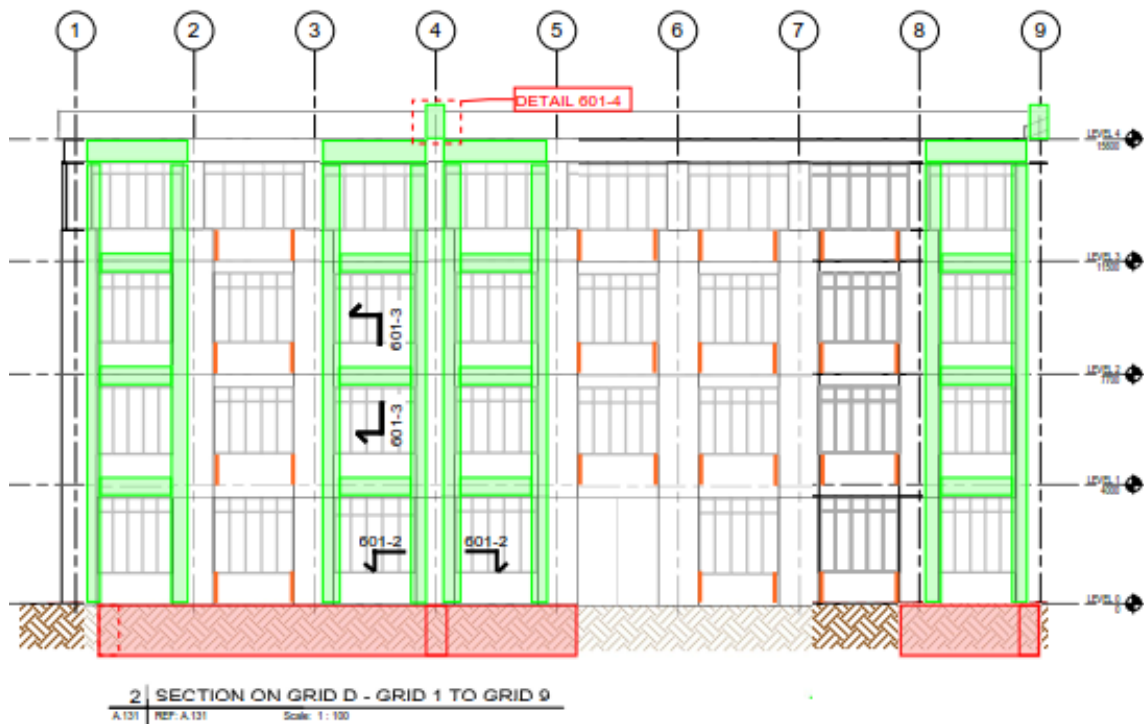

Figure 3: Grid d elevation showing conceptual retrofit scheme

DRAFT

3.0 Seismic parameters

3.1 Seismic Response

The earthquake structural design actions were calculated using NZS 1170.5. The factors used in the calculation of the seismic design coefficient, C_d , are described below:

Table 2 Seismic parameters

Item	Parameter	Comment / Reference
Soil Category	D	Deep or soft soil
Location	Christchurch	
Period, T	0.545	Calculated in AECOM 3D DDE
Spectral shape factor, $C_h(T)$	2.94	NZS 1170.5: 2004, table 3.1
Hazard Factor, Z	0.3	B1 Building Code (incl. amendment 12, February 2014)
Annual probability of exceedance	1000 years	Importance level 3 structure, refer table 3.3 in AS/NZS 1170.0:2002
Return period factor, R	1.3	Table 3.5 of NZS 1170.5: 2004
Near fault factor, $N(T,D)$	1	NZS 1170.5: 2004, table 3.7
Elastic Site Spectra, $C(T)$	1.15	NZS 1170.5: 2004, Eq. 3.1(1)
Ductility, μ	1.5 ¹	Calculated based on AECOM 3D DDE
Structural performance factor, S_p	0.85	NZS 1170.5: 2004, cl. 4.4.2
Structural ductility factor, k_μ	1.39	NZS 1170.5: 2004, cl. 5.2.1.1
Horizontal design action coefficient, $C_d(T)$	0.702	NZS 1170.5: 2004, cl. 5.2.1.1
Seismic mass	66 MN	Calculated in AECOM 2D DFR
Base shear, V_b	46.3 MN	NZS 1170.5: 2004, cl. 6.2.1.2
Height of action, h	11 m	Calculated in AECOM 3D DDE
Overturning moment, M	510 MNm	$M = V_b \times h$
34%NBS overturning moment	173 MNm	$M_{34\%} = M \times 34\%$
34%NBS base shear	15.7 MN	$V_{b,34\%} = M_{34\%} / h$

The building is limited to drift limits of 0.5% or 75mm overall drift of the top storey.

¹ Minimum ductility available calculated from the DDE is 1.65, therefore the new system will be designed for a ductility of 1.5 to prevent the existing structure from exceeding its minimum ductility capacity.

DRAFT

3.2 Seismic Demand

In the transverse direction there are six frames, with identical frames located on grid lines 1 and 21, 4 and 18, 9 and 13. The grid line 4 and 18 frame was modelled and designed for $1/6^{\text{th}}$ of the demand, which is 2.25 MN base shear or 24.8 MNm overturning moment. The frames on gridline 1 and 21 contribute less than $1/6^{\text{th}}$ of the demand but the frames on gridline 9 and 13 contribute more, therefore a $1/6^{\text{th}}$ per frame approach is appropriate.

In the longitudinal direction there are 20 sections of frame, with six double frames contributing 12 equivalent frames and eight single frames. Each equivalent frame on average is designed for $1/20^{\text{th}}$ of the demand, which is 675 kN base shear or 7.43 MNm overturning moment. The double frames located between grids 3 and 5 and similarly 17 and 19 at the other end have an extended foundation so have a greater capacity than the typical double frame.

DRAFT

4.0 Analysis Methodology

The retrofit schemes of three typical frames, one in the transverse and the other two in the longitudinal direction have been modelled and analysed using ETABS 2015 software.

The retrofit schemes seismic capacity has been assessed using a 2D Non-linear pushover (NLPO) analysis. NLPO is a static, nonlinear procedure in which the magnitude of the lateral loading is incrementally and proportionally increased in accordance with the NZS 1170.5 inverted triangle pattern. With the increase in the magnitude of the loading the capacity of a structure beyond its elastic limit up to its ultimate strength in the post-elastic range can be estimated. It is used to determine how progressive failure is likely to occur in buildings, and can identify the final failure mechanism. Refer to AECOM's 3D DFR for a detailed description of this procedure.

The NLPO was conducted up to a target displacement of 75mm in both directions.

The width of the new column and link properties at the base of the new column were incrementally adjusted until the base shear indicated in section 2.1 was reached at a displacement less than 75mm. In the longitudinal direction the section properties of the beams were also adjusted until the desired base shear was reached.

DRAFT

5.0 Structural Model

5.1 Modelling

Refer to Appendix A for graphical representations of the three retrofit scheme models.

5.1.1 Material Properties

The pre-existing beams and columns use the material properties of the concrete, reinforcement and structural steel developed during intrusive investigations and the properties are outlined in AECOM's 3D DFR.

The new elements have been modelled with modern material properties of 30 MPa concrete, 500 MPa reinforcement and 1000 MPa post-tensioning bars.

5.1.2 Elements

The pre-existing columns and beams have been modelled as line elements with section properties of the element cores outlined in AECOM's 3D DFR.

New beams have been modelled as line elements with retrofitted section dimensions shown in retrofit scheme drawing.

New column sections have been modelled as thin walled shells. This allows for the column section to behave similarly to a wall element and develop an internal couple. The internal couple created was used to determine the shear and axial forces being transferred through the post-tensioning.

The foundation beams have been modelled as thin walled shell elements.

5.1.3 Links

Multi-linear elastic links with non-linear rotational properties are located at the beam ends adjacent to the face of the new column sections to model yielding of the beam elements.

Multi-linear elastic links with linear elastic properties in shear and axial have been created between the new column sections and the pre-existing column cores. They are linear elastic to measure the force transfer to design the post-tensioning.

The foundation under the pre-existing column cores are to remain and reinforcing bars are to be drilled through the existing foundation. The same multi-linear elastic links with linear elastic properties in shear and axial have been created between the foundation elements to determine the force transfer.

Under the new column section are two non-linear axial links and one non-linear shear link. The axial links are designed to have the tension capacity of the reinforcement in the new columns and a significantly stronger compression capacity. The links are placed at opposite edges of the new section and simulate the couple developed in the section. The shear link is connected at the middle of the section and has a capacity equivalent to half the shear capacity of all the reinforcement in the column. This prevents the reinforcement from failing in a combination of shear and axial.

5.1.4 Soil Springs

The foundation conditions have been approximated with stiff horizontal spring supports and vertical non-linear gap elements (compression only links). Under the existing column locations non-linear hook elements (tension only links) have been added to the gap elements. The hook elements provide a tension force in uplift, which is equivalent to the existing mass in the structure the foundations can mobilise.

The spring stiffness is based on geotechnical recommendations which have assumed that the foundations have been founded on natural medium dense fine silty sand. For further information refer to AECOM's 3D DFR.

5.1.5 Applied Loads

The NZS 1170.5 push pattern is developed by setting the mass source for horizontal masses only. The total mass of each storey calculated in AECOM's 2D DFR was scaled then applied horizontally at each level and assigned to the mass source. ETAB'S inbuilt NZS 1170.5 load pattern function uses the masses to develop the inverted triangular push pattern.

There is no dead load from the existing structure assigned to the model and the modifiers for mass and weight are set to 0. The mass is instead assigned as vertical loads equivalent to the gravity loads calculated during

DRAFT

AECOM's load takedown in the 2D DFR. Mass from the adjacent column is indirectly applied through the hook elements in the foundation.

The self-weight of the new structure is applied through loading with dead load.

5.2 Analysis Results

Refer to Appendix B for the NLPO curves.

5.2.1 Transverse Direction

The NLPO curve provides a base shear of 2260 kN and 2230 kN in the positive and negative direction respectively. These are both similar to the target base shear of 2250 kN. Assuming that each frame will take on average $1/6^{\text{th}}$ of the overall base shear demand, the dimensions used in the retrofit scheme model will provide a suitable retrofit solution.

5.2.2 Longitudinal Direction

The NLPO curve of the extended foundation double frame provides a base shear of 1840 kN and 1900 kN in the positive and negative directions. The NLPO curve of the typical double frame provides a base shear of 1150 kN in both directions. It is assumed that a single frame will provide half the base shear of the double frame which is reasonable based on the redundancy in the longitudinal direction. Combining the base shears provides an overall base shear of 14.5 MN which is greater than the 13.5 MN required.

DRAFT

Appendix A

ETABS Structural Models

DRAFT

Transverse Direction Frame

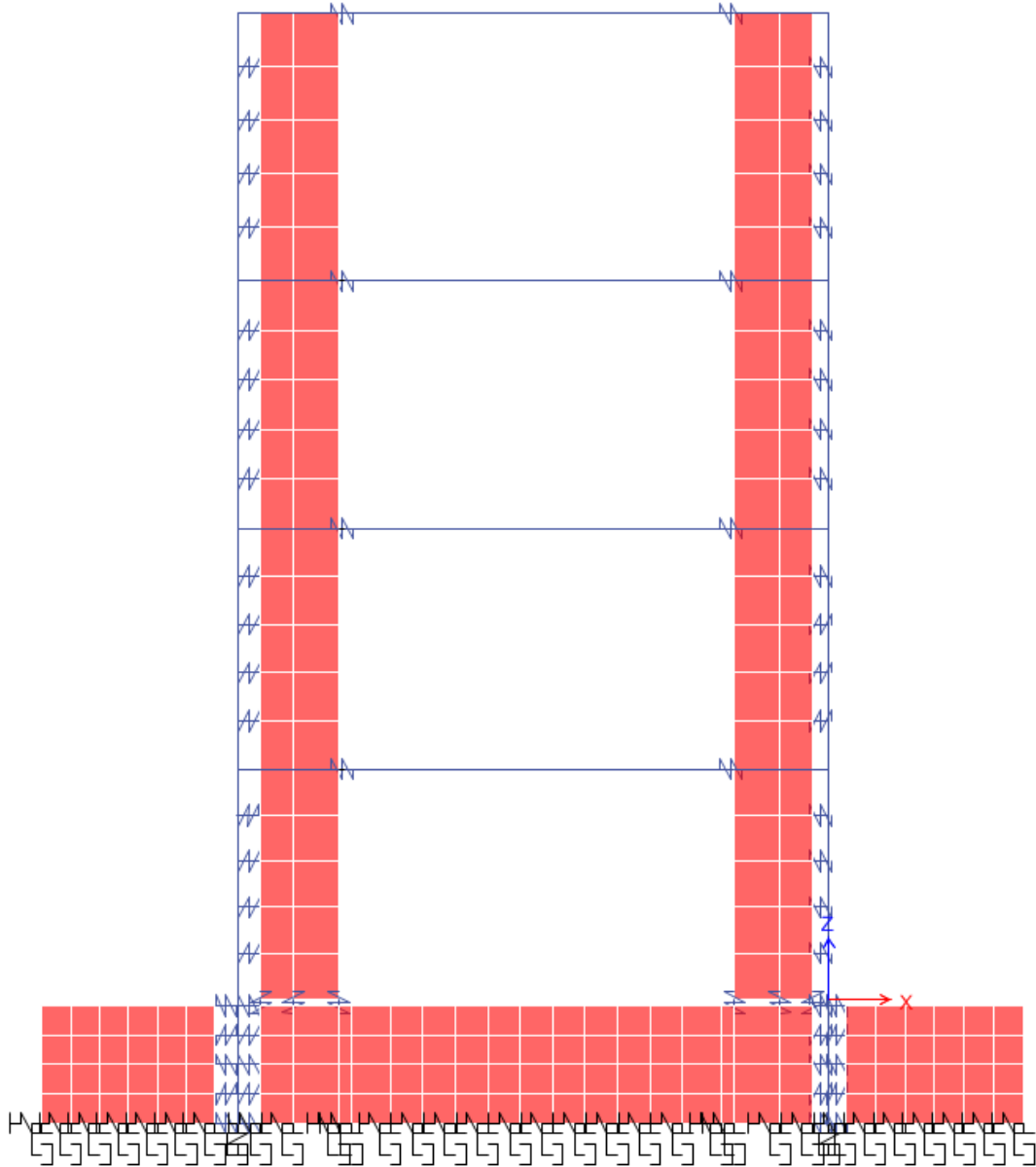

Figure 4: Model of transverse direction frame

DRAFT

Longitudinal Direction Double Frame with Extended Foundation Beam

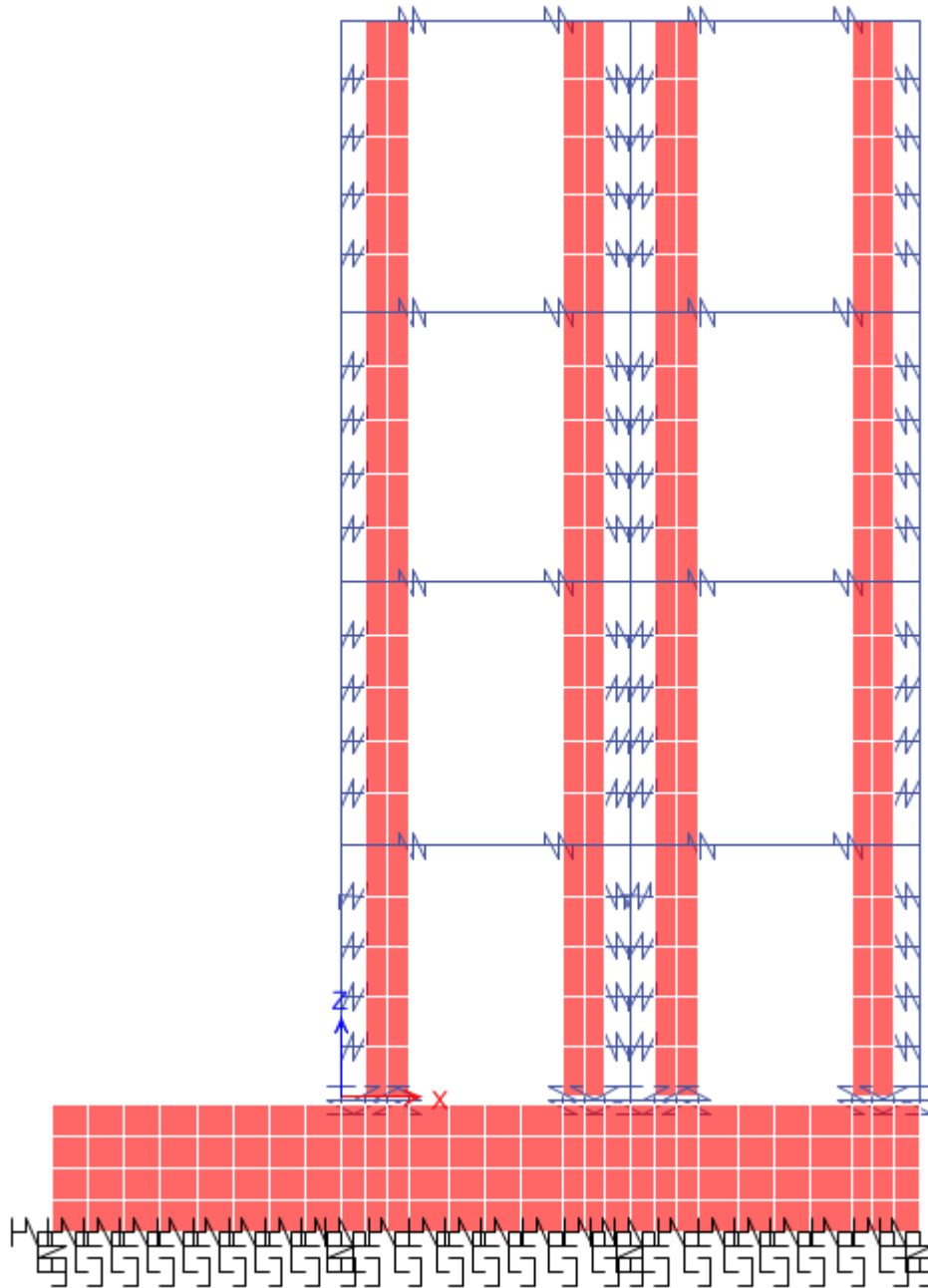

Figure 5: Model of longitudinal direction double frame with extended foundation beam

DRAFT

Longitudinal Direction Typical Double Frame

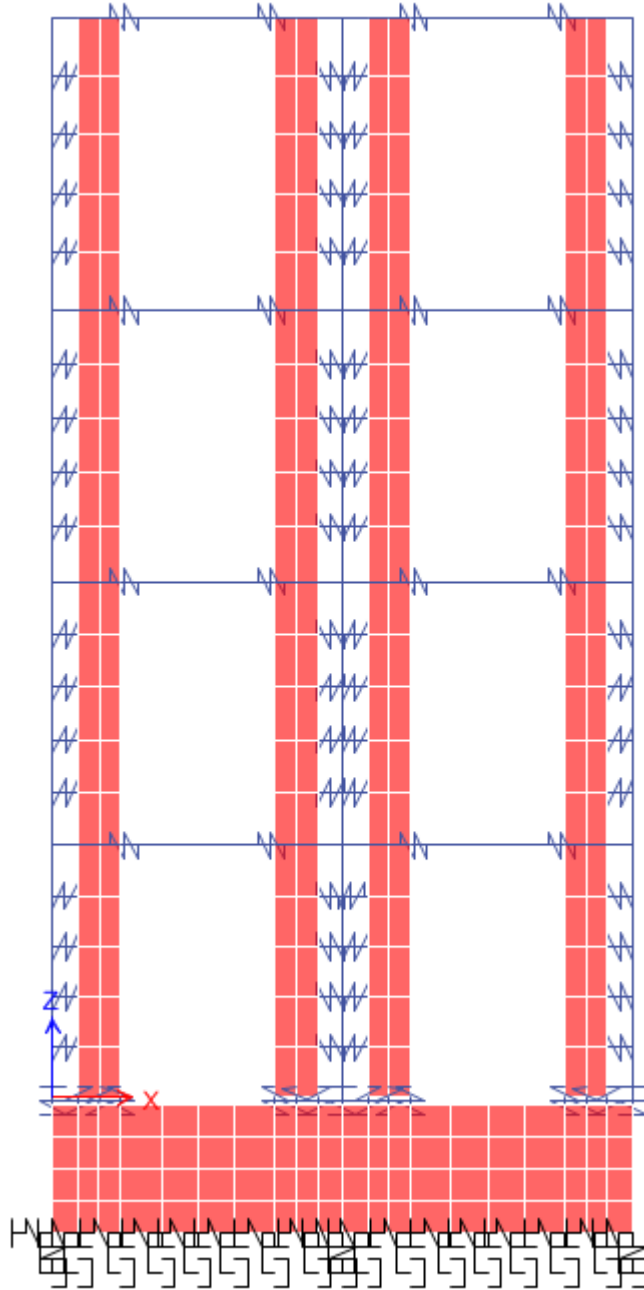

Figure 6: Model of longitudinal direction typical double frame

D R A F T

Appendix B

Non-linear Pushover Curves

DRAFT

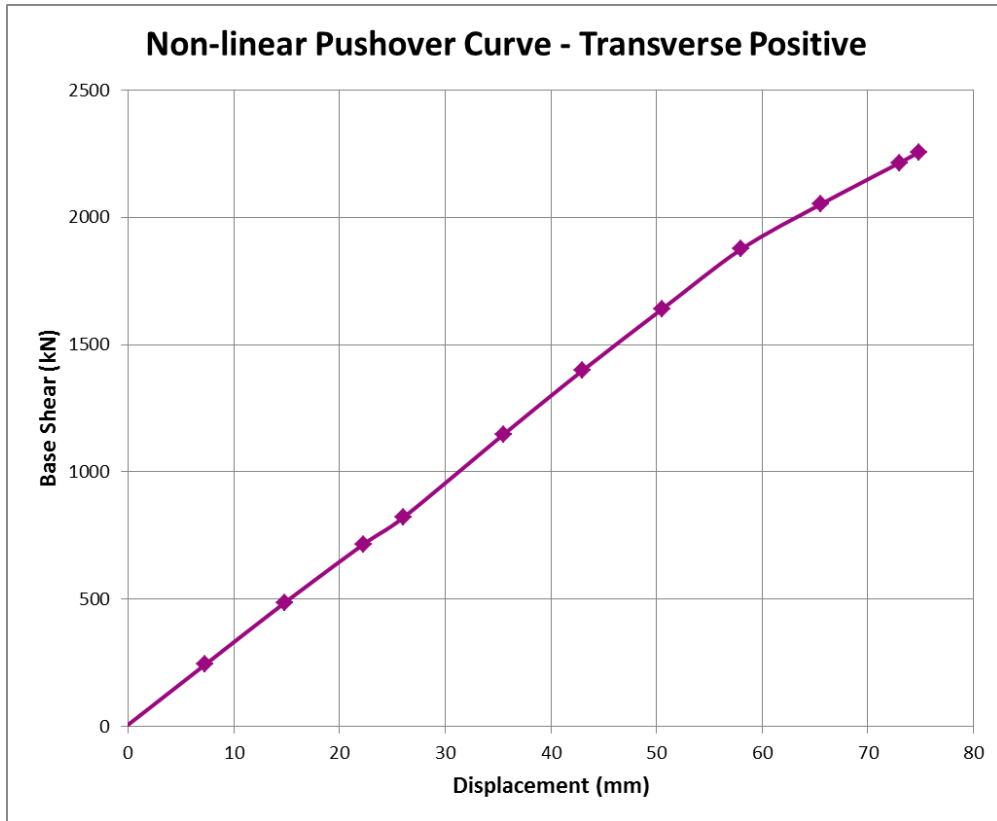

Figure 7: Non-linear pushover curve – transverse frame positive push

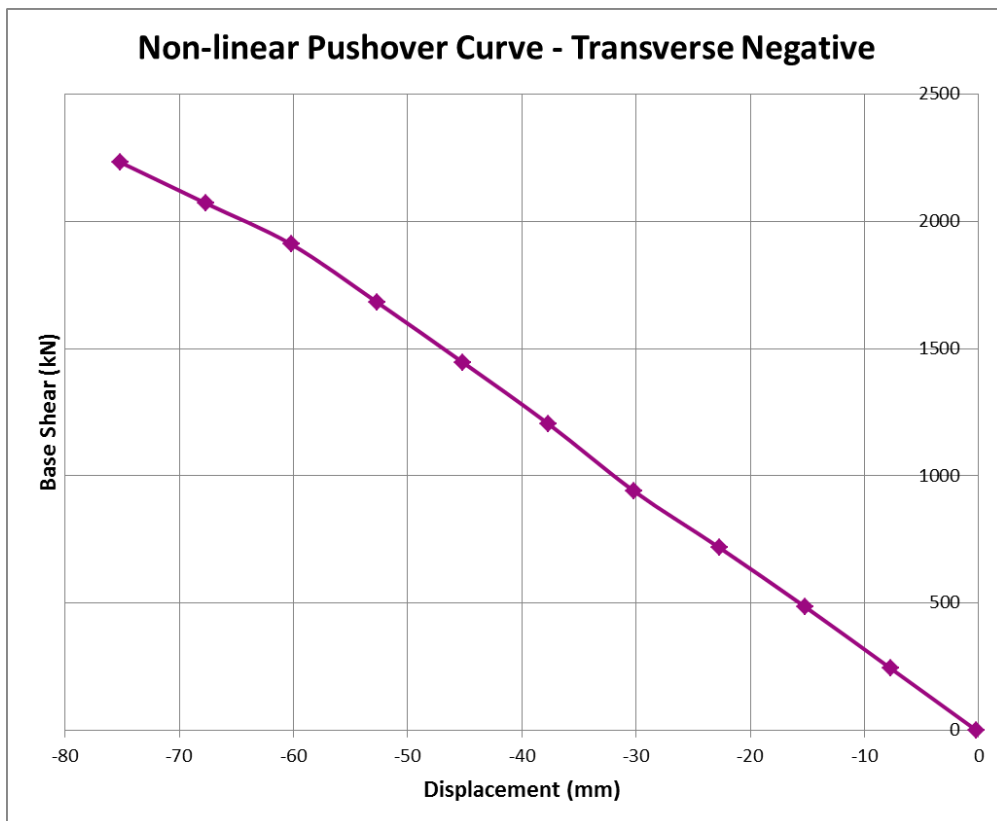

Figure 8: Non-linear pushover curve – transverse frame negative push

DRAFT

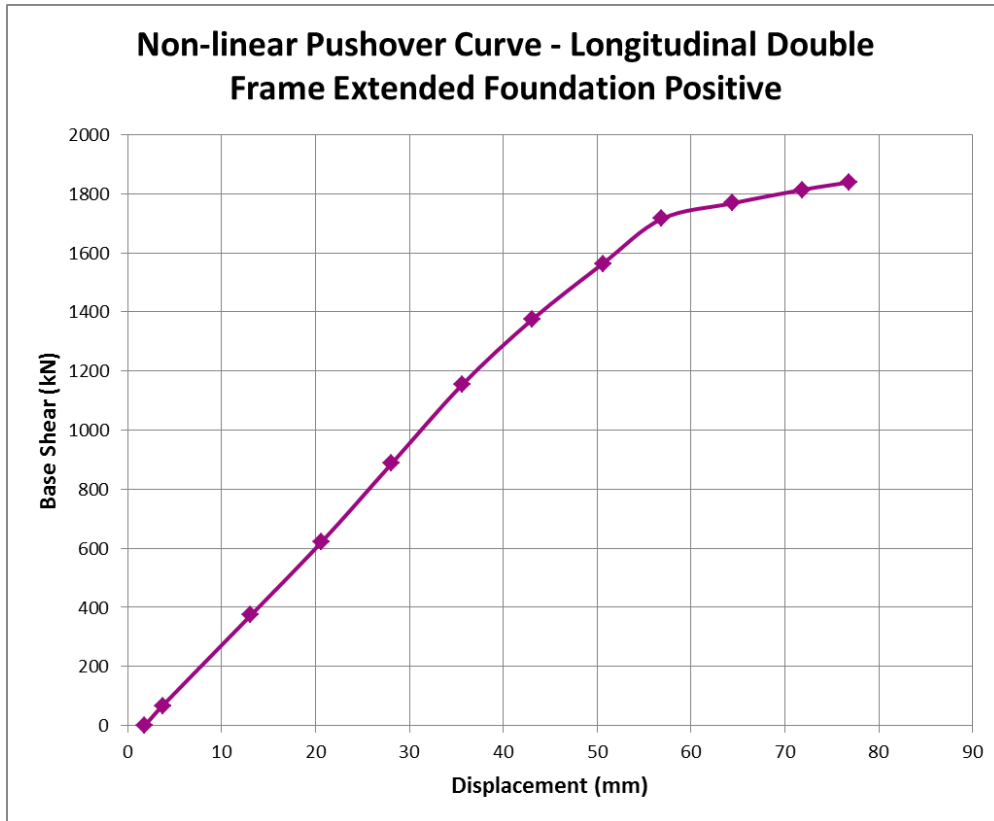

Figure 9: Non-linear pushover curve – longitudinal double frame extended foundation positive push

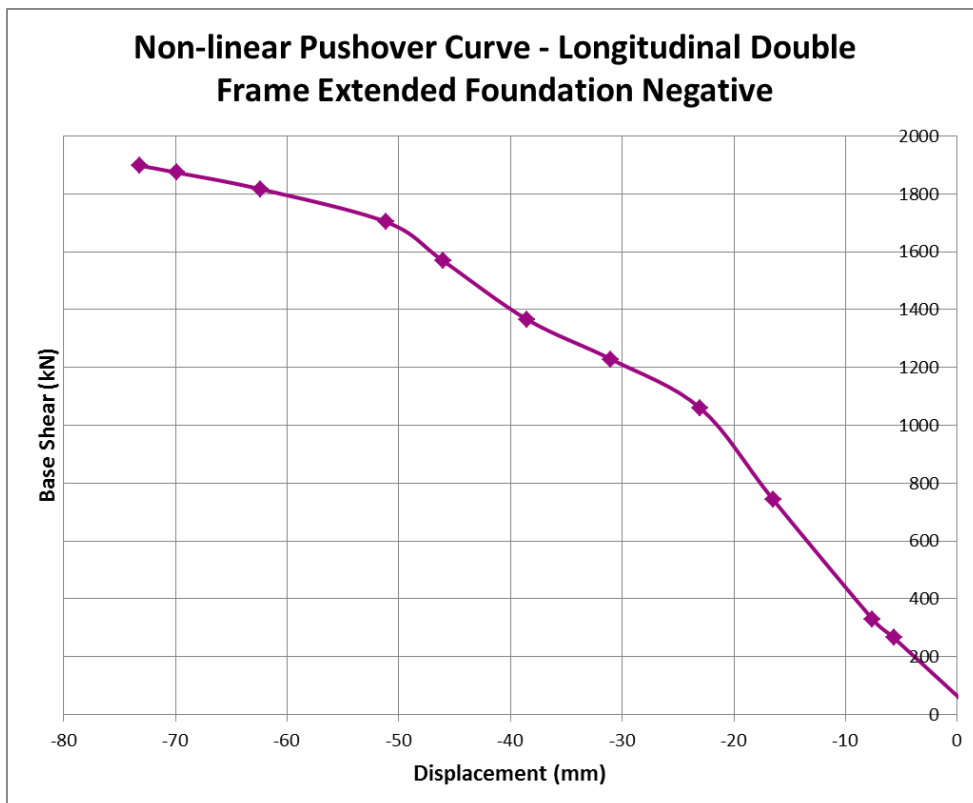

Figure 10: Non-linear pushover curve – longitudinal double frame extended foundation negative push

DRAFT

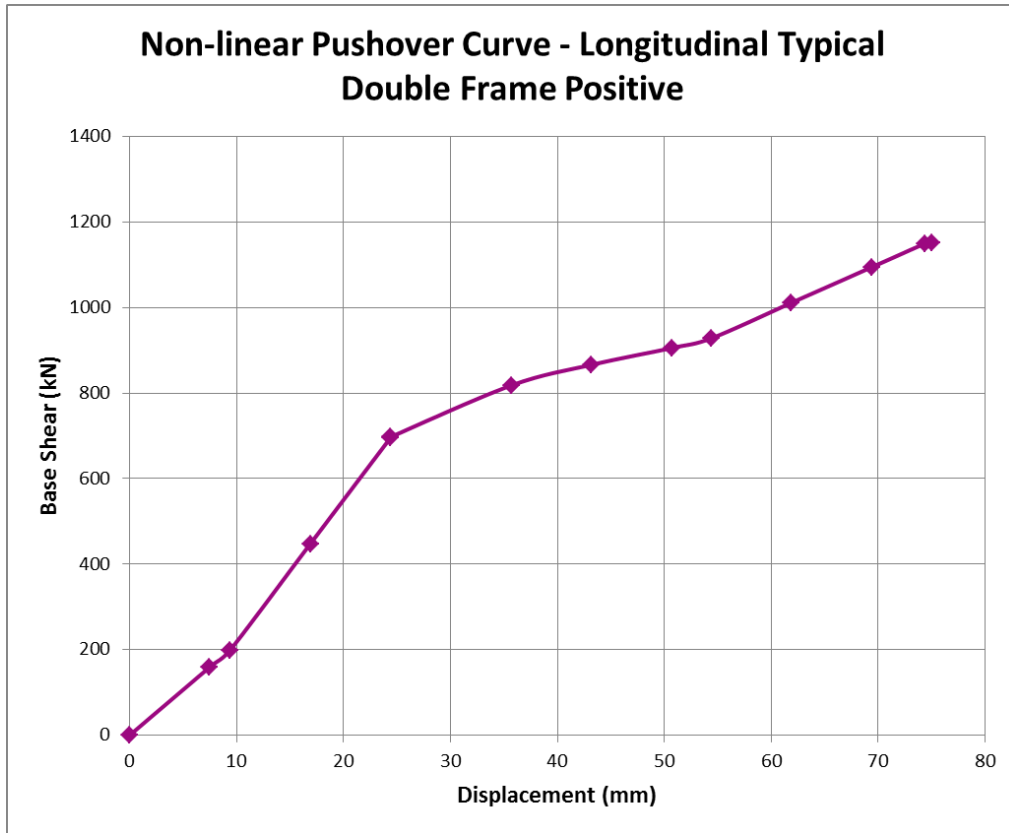

Figure 11: Non-linear pushover curve – longitudinal typical double frame positive push

DRAFT

Appendix C

Conceptual Retrofit Scheme Drawings



GRAND NATIONAL STAND

STRUCTURAL SKETCH LIST

- DRG-101 DEMOLITION PLAN - LEVEL 0
- DRG-102 DEMOLITION PLAN - LEVEL 1 TO 3
- DRG-103 DEMOLITION PLAN - LEVEL 4
- DRG-104 PROPPING LAYOUT - SHEET 1
- DRG-105 PROPPING LAYOUT - SHEET 2
- DRG-201 SHEAR FAILURE REMEDIATION. SHEET 1. LIFT CORE
- DRG-202 SHEAR FAILURE REMEDIATION. SHEET 2
- DRG-301 NEW FOUNDATION LAYOUT
- DRG-302 NEW COLUMN LAYOUT. LEVEL 0 TO 4
- DRG-501 SECTION - SHEET 1. GRIDLINE D
- DRG-502 SECTION - SHEET 2. GRIDLINE C
- DRG-503 SECTION - SHEET 3. TRANSVERSE SECTION
- DRG-601 DETAILS - SHEET 1
- DRG-602 DETAILS - SHEET 2
- DRG-603 DETAILS - SHEET 3

FOR PRICING ONLY

This drawing is confidential and shall only be used for the purpose of this project. The signing of this title block confirms the design and drafting of this project have been prepared and checked in accordance with the AECOM quality assurance system to ISO 9001-2000.

**GRAND NATIONAL STAND CONCEPTUAL
RETROFIT SCHEME TO 34%NBS**

CANTERBURY JOCKEY CLUB, RICCARTON PARK, RACECOURSE ROAD, CHRISTCHURCH

Issued for pricing 18/04/2016

ISSUE/REVISION		
I/R	DATE	DESCRIPTION
A	22/04/2016	ISSUED FOR PRICING
-	18/04/2016	ISSUED FOR PRICING

AECOM

60439900

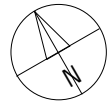

EXISTING GROUND FLOOR

Scale: 1 : 150

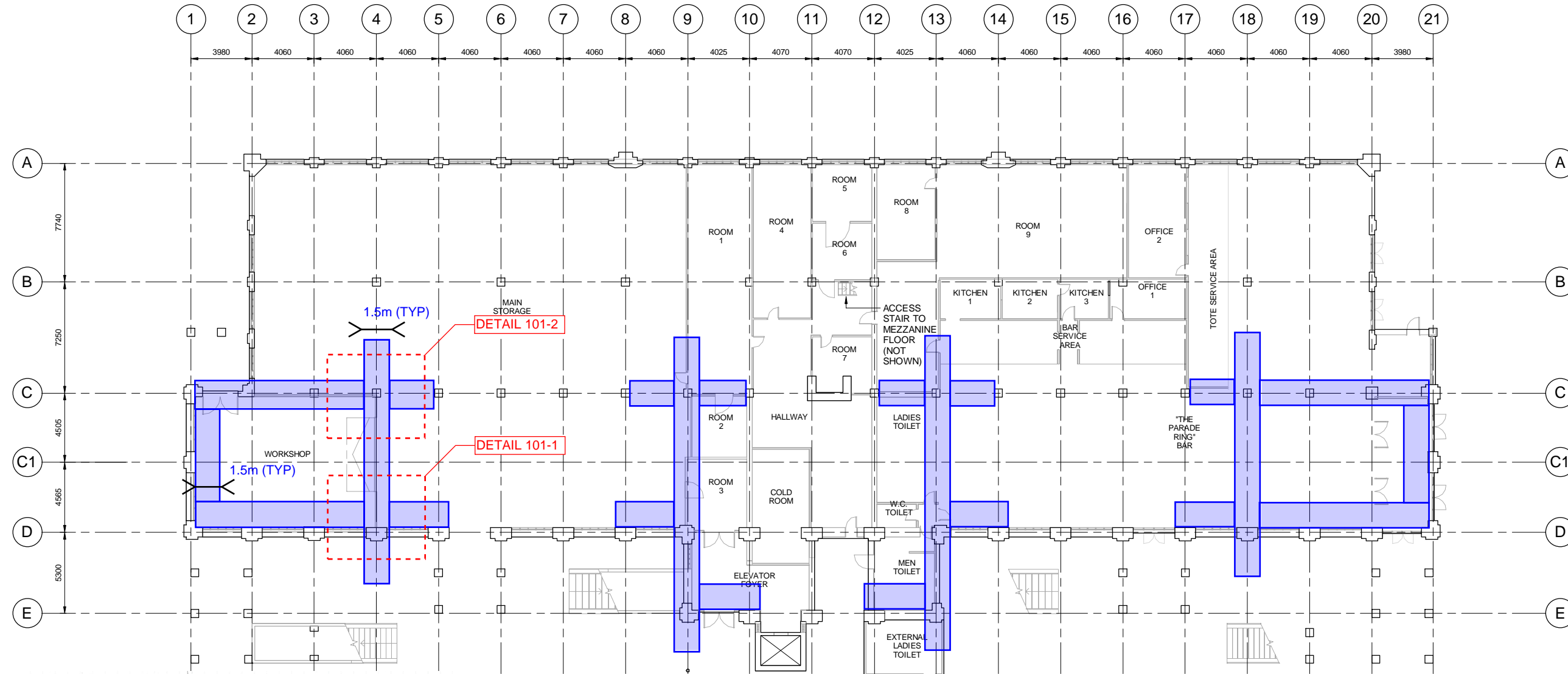

PROJECT
GRAND NATIONAL STAND
CONCEPTUAL
RETROFIT SCHEME

CANTERBURY JOCKEY CLUB,
 CHRISTCHURCH

CLIENT
CANTERBURY JOCKEY CLUB

CONSULTANT
 AECOM New Zealand Limited
 2 Hazeldean Rd, Addington
 Christchurch, NZ 8024
 +64 3 966 6000 tel +64 3 966 6001 fax
 www.aecom.com

Key
 AREAS TO DEMOLISH

PROJECT MANAGEMENT INITIALS

MC	NR	CO
DESIGNER	CHECKED	APPROVED

ISSUE/REVISION

I/R	DATE	DESCRIPTION
A	22/4/2016	ISSUED FOR PRICING
-	18/4/2016	ISSUED FOR PRICING

KEY PLAN

PROJECT NUMBER
 60439900

SHEET TITLE
 DEMOLITION PLAN - LEVEL 0

SHEET NUMBER
 60439900 DRG-101

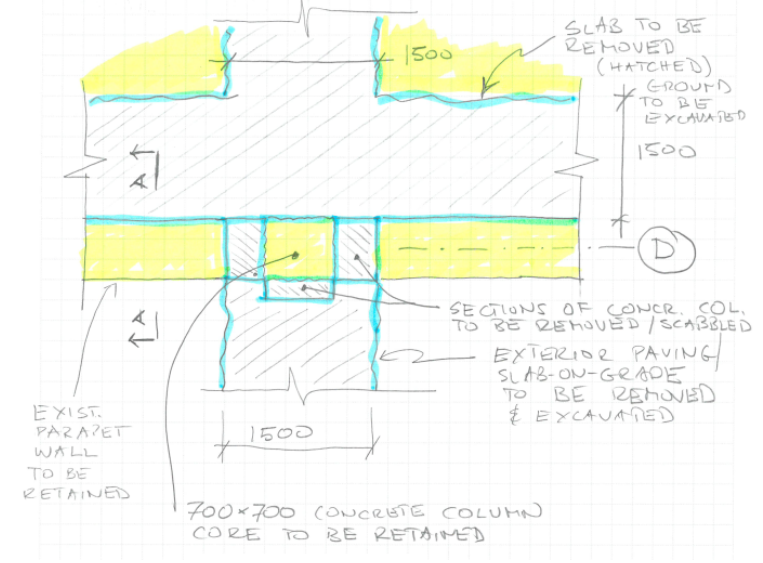

DETAIL 101-1
PLAN
 (N.T.S.)

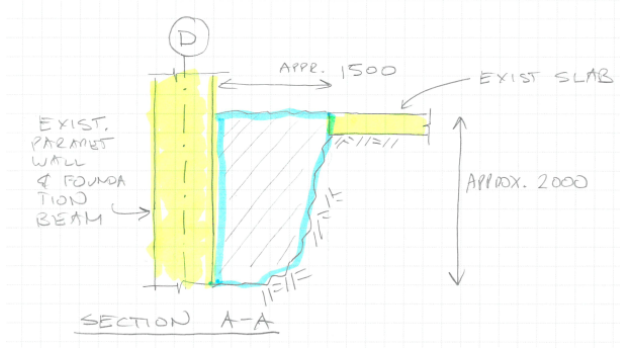

DETAIL 101-2
SECTION
 (N.T.S.)

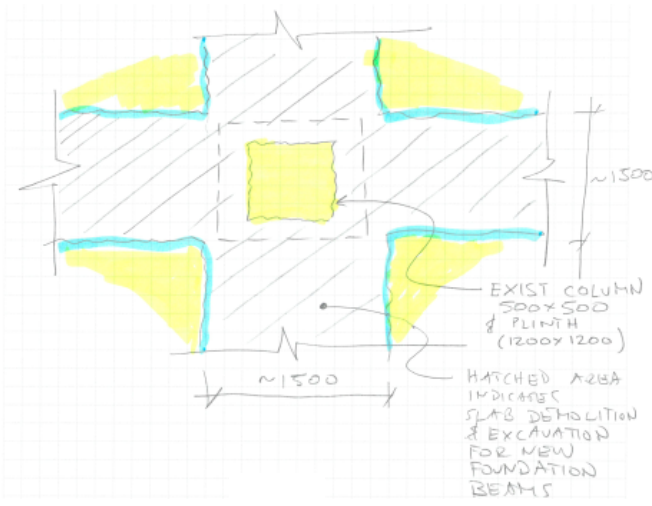

DETAIL 101-2
PLAN
 (N.T.S.)

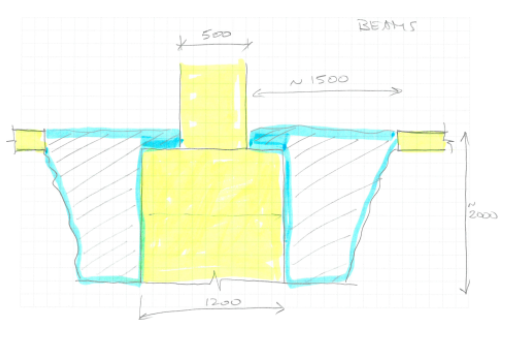

DETAIL 101-2
SECTION
 (N.T.S.)

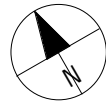

 AREAS TO DEMOLISH

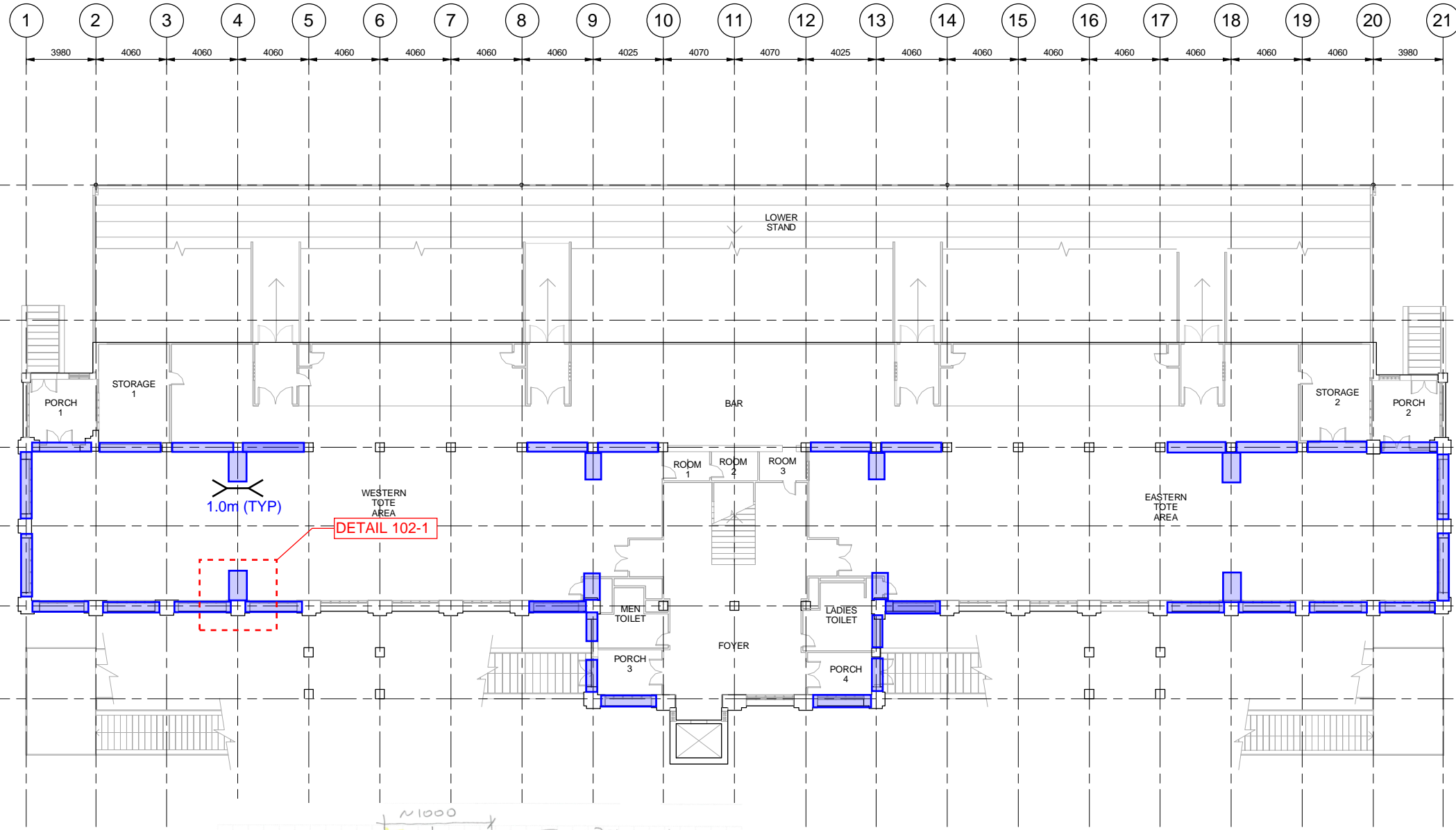

EXISTING FLOOR 1
Scale: 1 : 150

**DETAILS ALSO
APPLICABLE TO
FLOOR 2 AND 3**

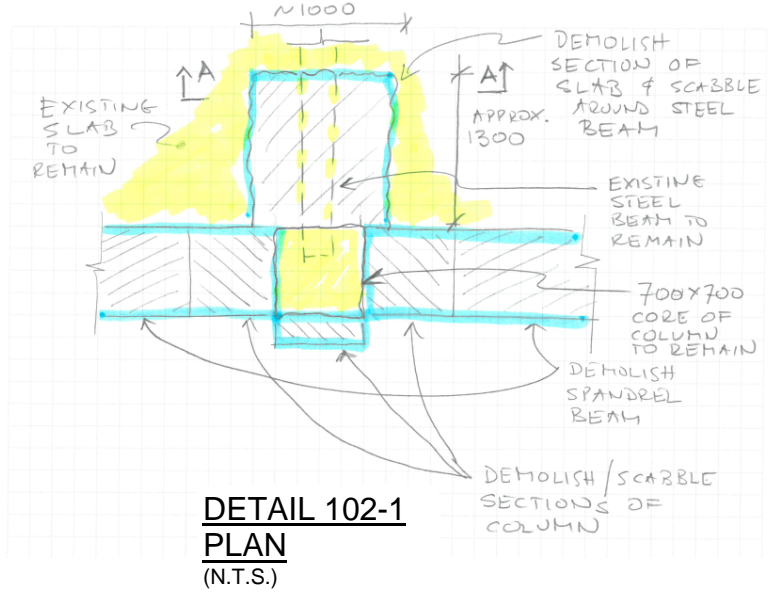

**DETAIL 102-1
PLAN
(N.T.S.)**

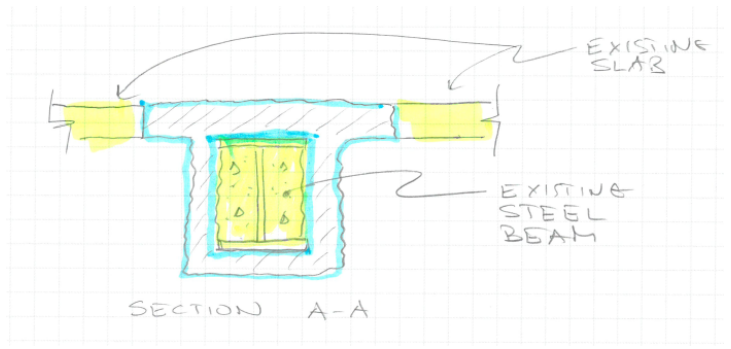

**DETAIL 102-1
SECTION
(N.T.S.)**

PROJECT MANAGEMENT INITIALS

MC	NR	CO
DESIGNER	CHECKED	APPROVED

ISSUE/REVISION

I/R	DATE	DESCRIPTION
-	18/4/2016	ISSUED FOR PRICING

KEY PLAN

PROJECT NUMBER

60439900

SHEET TITLE

DEMOLITION PLAN - LEVEL 1
TO 3

SHEET NUMBER

60439900-DRG-102

This drawing is confidential and shall only be used for the purpose of this project. The signing of this title block confirms the design and drafting of this project have been prepared and checked in accordance with the AECOM quality assurance system to ISO 9001-2000.

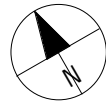

 AREAS TO DEMOLISH

PROJECT MANAGEMENT INITIALS

MC	NR	CO
DESIGNER	CHECKED	APPROVED

ISSUE/REVISION

I/R	DATE	DESCRIPTION
A	18/4/2016	ISSUED FOR PRICING

KEY PLAN

PROJECT NUMBER

60439900

SHEET TITLE

DEMOLITION PLAN - LEVEL 4

SHEET NUMBER

60439900-DRG-103

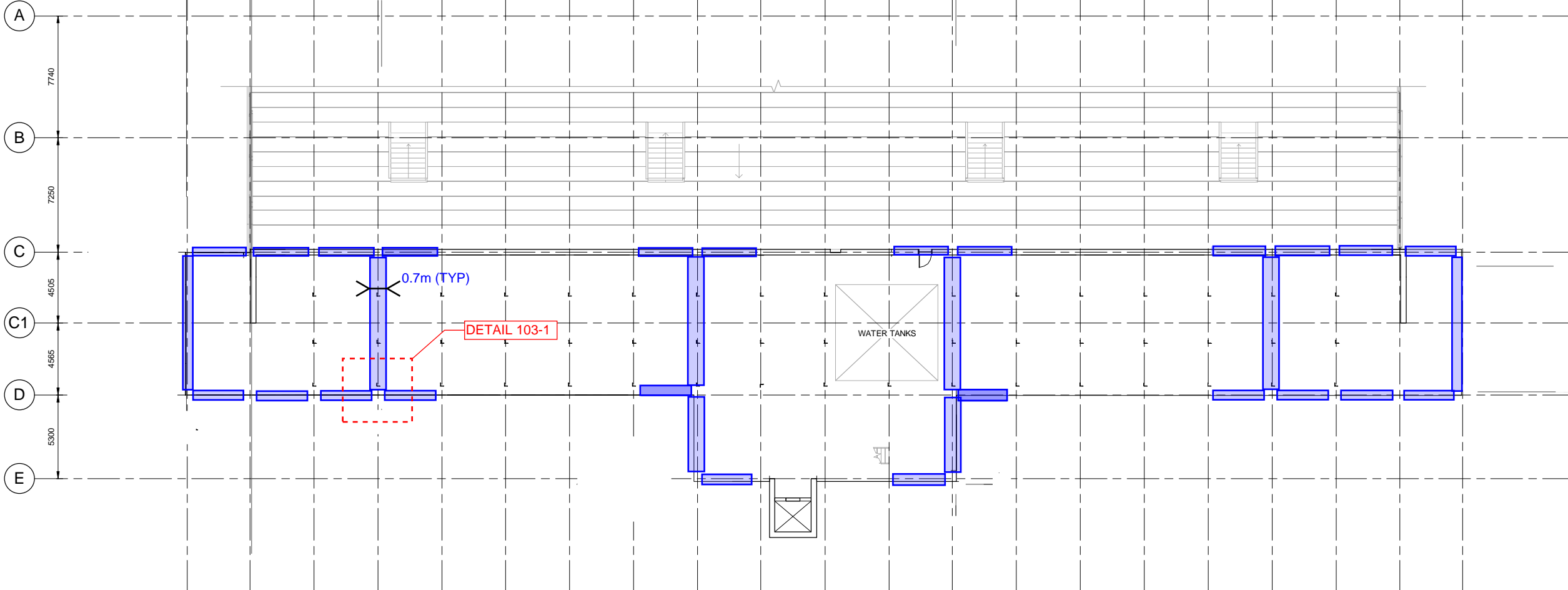
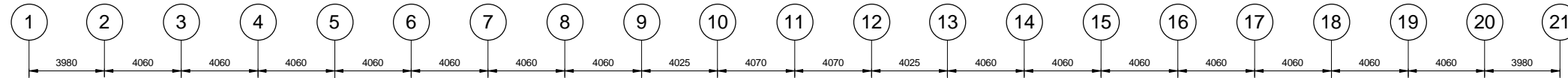

EXISTING FLOOR 4
Scale: 1 : 150

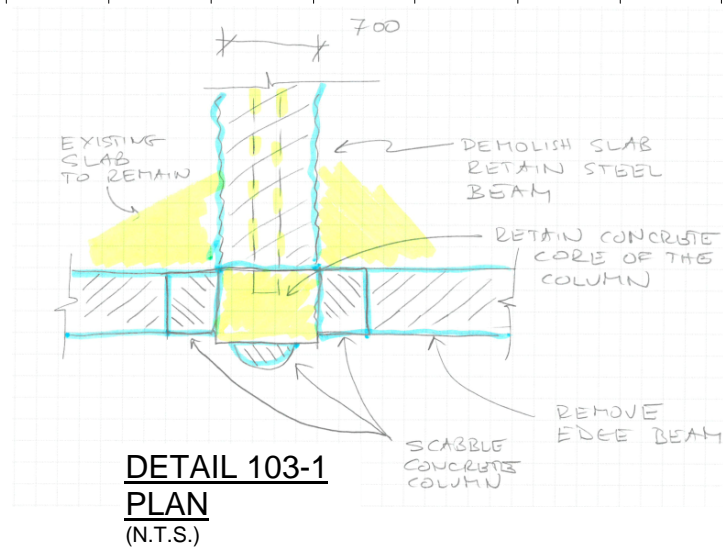

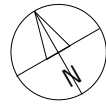

EXISTING GROUND FLOOR

Scale: 1 : 150

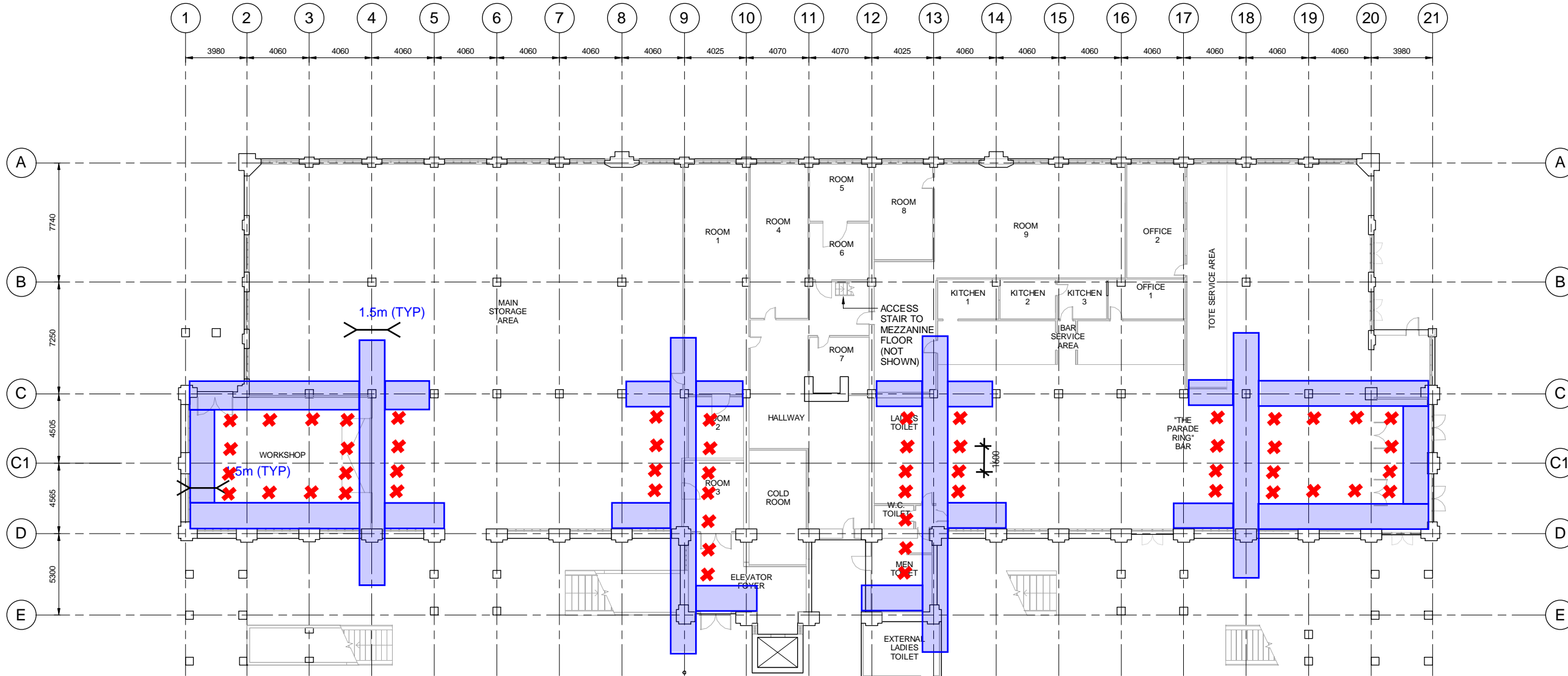

54 PROPS PER FLOOR



PROJECT
 GRAND NATIONAL
 STAND
 CONCEPTUAL
 RETROFIT SCHEME

CANTERBURY JOCKEY CLUB,
 CHRISTCHURCH

CLIENT
 CANTERBURY
 JOCKEY CLUB

CONSULTANT
 AECOM New Zealand Limited
 2 Hazeldean Rd, Addington
 Christchurch, NZ 8024
 +64 3 966 6000 tel +64 3 966 6001 fax
 www.aecom.com

Key
 [Blue Box] AREAS TO DEMOLISH
 [Red X] PROP LOCATION

PROJECT MANAGEMENT INITIALS

MC	NR	CO
DESIGNER	CHECKED	APPROVED

ISSUE/REVISION

I/R	DATE	DESCRIPTION
A	22/4/2016	ISSUED FOR PRICING
-	18/4/2016	ISSUED FOR PRICING

KEY PLAN

PROJECT NUMBER
 60439900

SHEET TITLE
 PROPPING LAYOUT - SHEET 1

SHEET NUMBER
 60439900 DRG-104

This drawing is confidential and shall only be used for the purpose of this project. The signing of this title block confirms the design and drafting of this project have been prepared and checked in accordance with the AECOM quality assurance system to ISO 9001:2000.

SECTION ON GRIDS 4 & 18

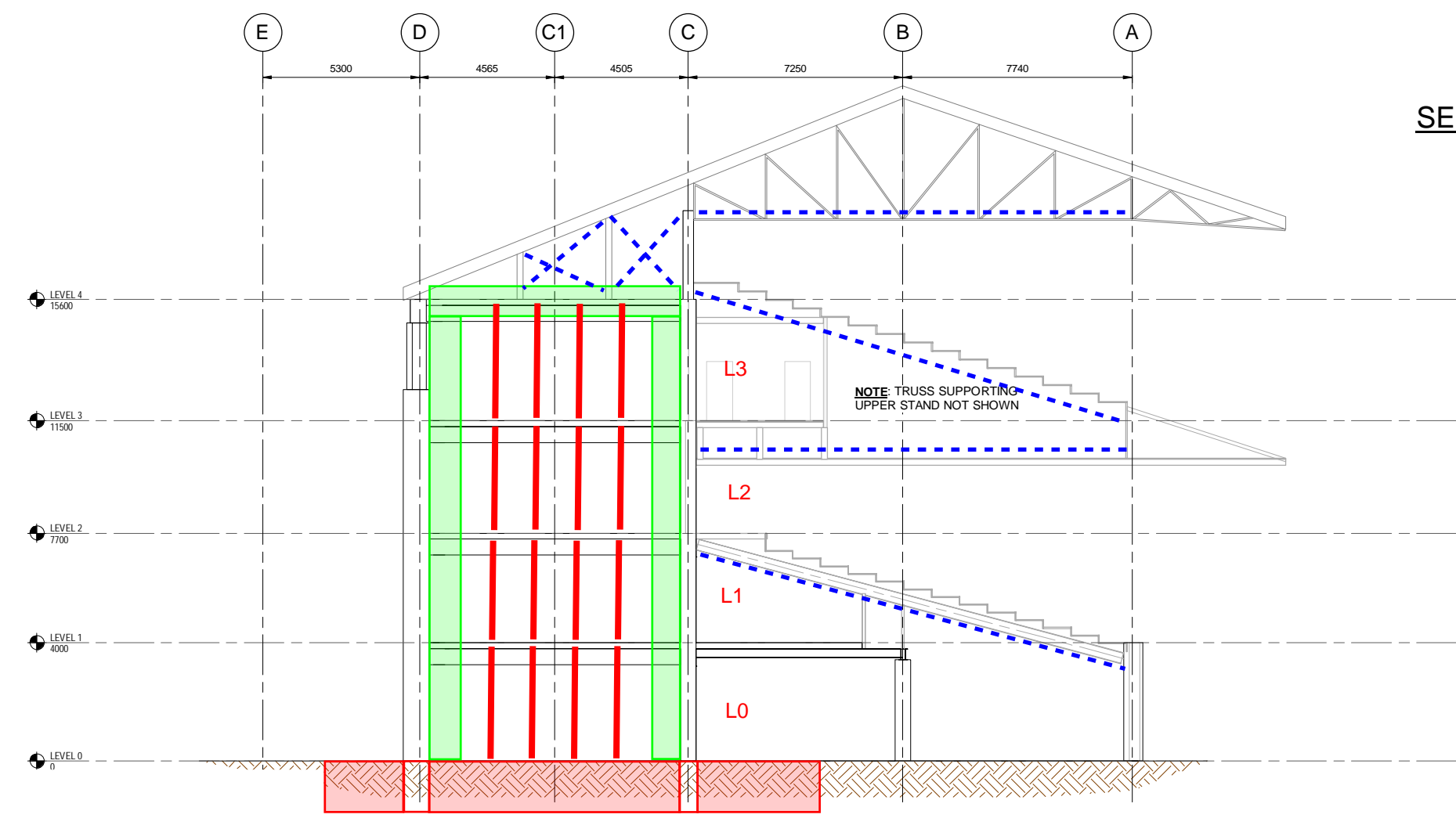

- NEW FOUNDATION BEAM
- NEW "SUPER COLUMNS" AND BEAMS
- NEW TENSION BRACING 32mm REID BRACE
- PROP LOCATION

SECTION ON GRIDS 9 & 13

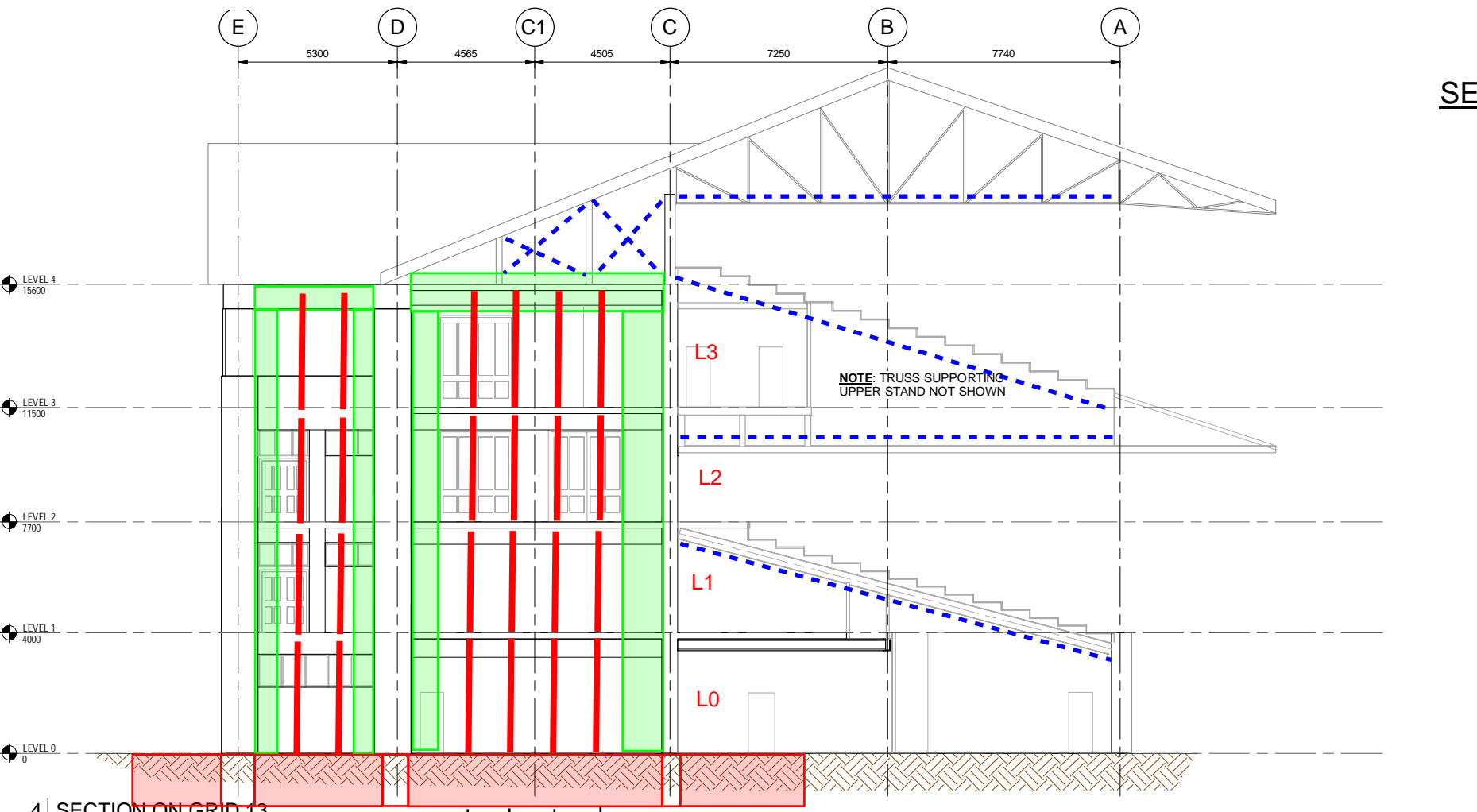

PROP	SAFE WORKING LOAD (SWL) UNFACTORED
L0	100 kN
L1	75 kN
L2	50 kN
L3	25 kN

PROJECT MANAGEMENT INITIALS

MC	NR	CO
DESIGNER	CHECKED	APPROVED

ISSUE/REVISION

I/R	DATE	DESCRIPTION
A	22/4/2016	ISSUED FOR PRICING
-	18/4/2016	ISSUED FOR PRICING

KEY PLAN

PROJECT NUMBER

60439900

SHEET TITLE

PROPPING LAYOUT - SHEET 2

SHEET NUMBER

60439900-DRG-105

PROJECT MANAGEMENT INITIALS

NR	CO	CO
DESIGNER	CHECKED	APPROVED

ISSUE/REVISION

-	18/4/2016	ISSUED FOR PRICING
I/R	DATE	DESCRIPTION

KEY PLAN

PROJECT NUMBER

60439900

SHEET TITLE

SHEAR FAILURE REMEDIATION
SHEET 1
LIFT CORE

SHEET NUMBER

60439900-DRG-201

This drawing is confidential and shall only be used for the purpose of this project. The signing of this title block confirms the design and drafting of this project have been prepared and checked in accordance with the AECOM quality assurance system to ISO 9001:2000.

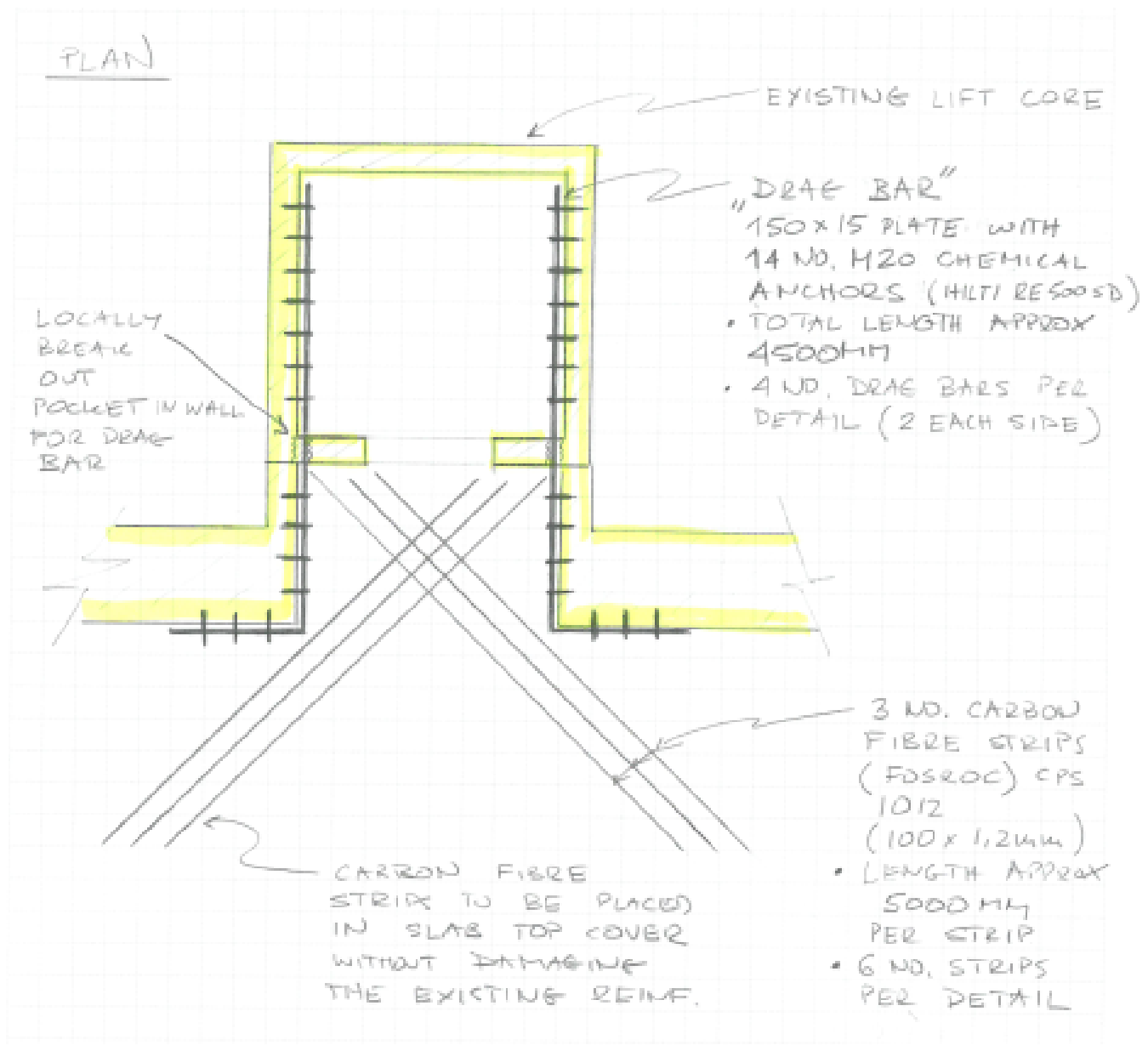

DETAIL 201-1
 Conceptual retrofit for liftcore shaft
 4no. locations in total (level 1 to 4)
 (N.T.S.)

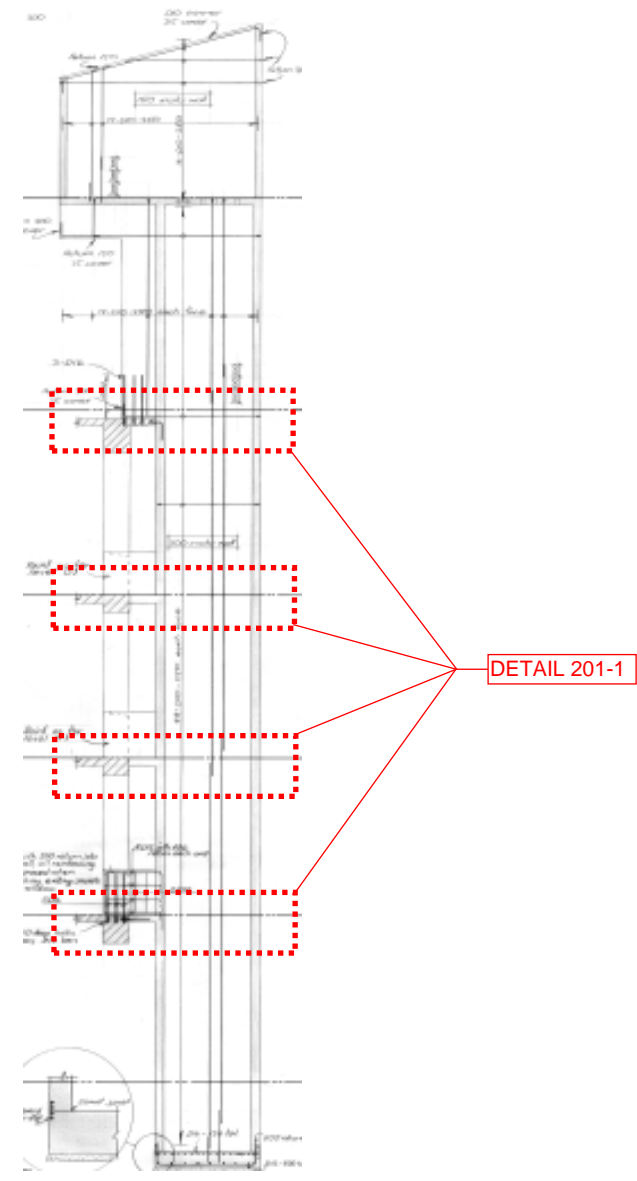

LIFT CORE
DETAIL 201-1 locations

(N.T.S.)

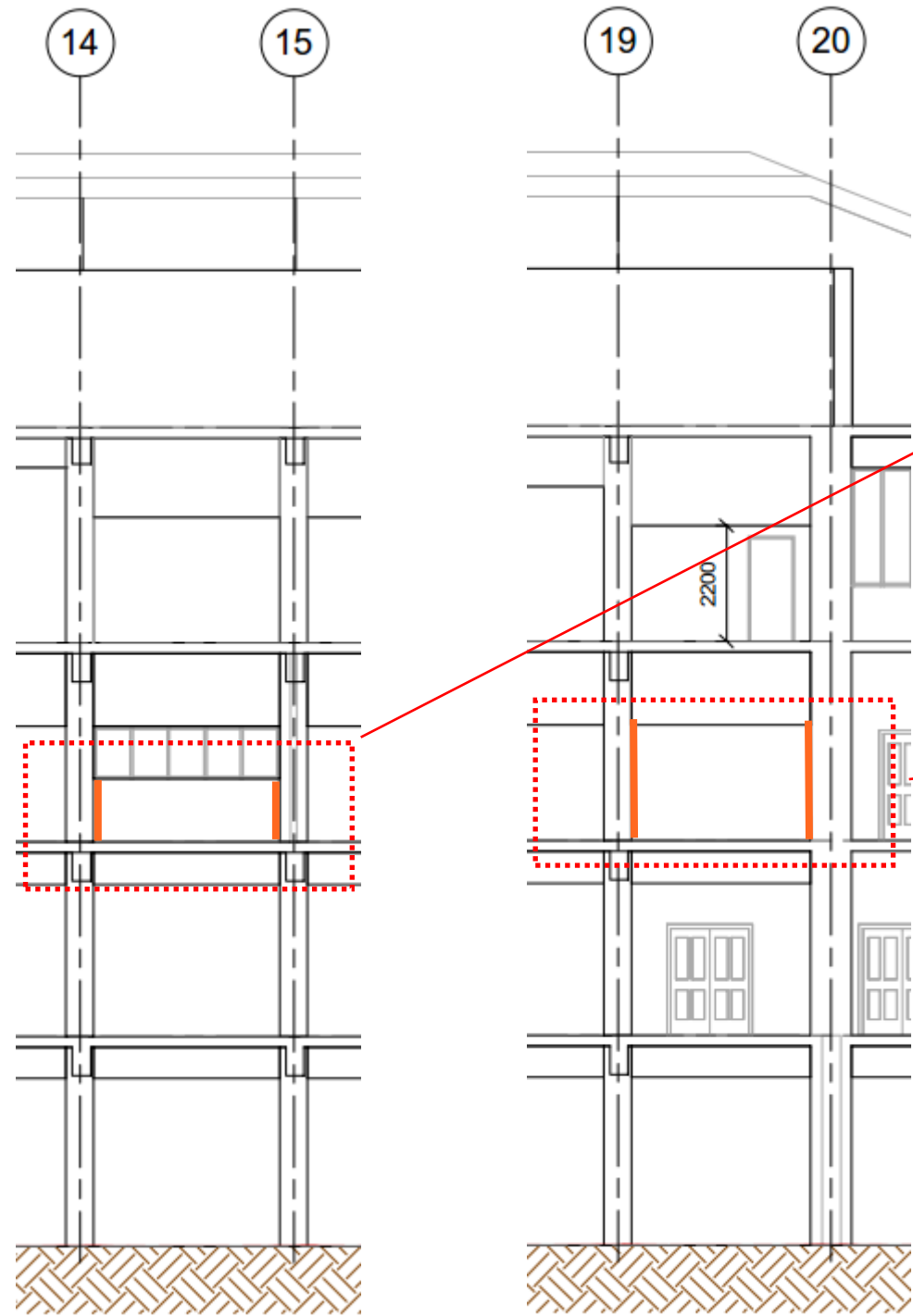

SECTION ON GRID C (14-15)
 Cut slots in the parapet beam adjacent to the columns
 Level 2
 (N.T.S.)

SECTION ON GRID C (19-20)
 Cut slots in the infill wall adjacent to the columns.
 Provide bracketry for out-of-plane loads
 Level 2
 (N.T.S.)



This drawing is confidential and shall only be used for the purpose of this project. The signing of this title block confirms the design and drafting of this project have been prepared and checked in accordance with the AECOM quality assurance system to ISO 9001-2000.

PROJECT MANAGEMENT INITIALS

NR	MF	CT
DESIGNER	CHECKED	APPROVED

ISSUE/REVISION

I/R	DATE	DESCRIPTION
-	18/4/2016	ISSUED FOR PRICING

KEY PLAN

PROJECT NUMBER

60439900

SHEET TITLE

SHEAR FAILURE REMEDIATION
 SHEET 2

SHEET NUMBER

60439900-DRG-202

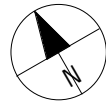

PROJECT MANAGEMENT INITIALS

MC	NR	CO
DESIGNER	CHECKED	APPROVED

ISSUE/REVISION

-	18/4/2016	ISSUED FOR PRICING
I/R	DATE	DESCRIPTION

KEY PLAN

FOUNDATION LAYOUT

Scale: 1 : 150

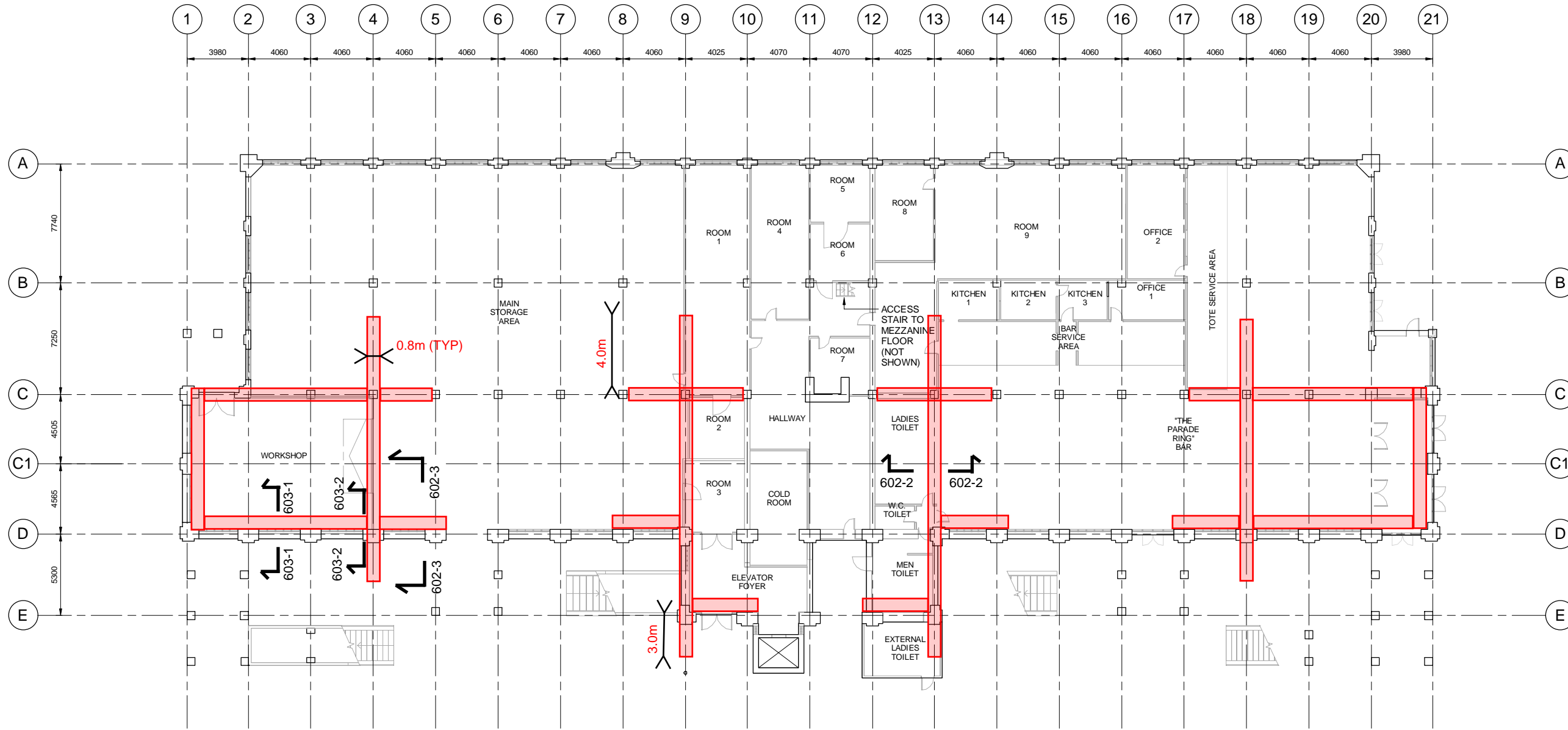

This drawing is confidential and shall only be used for the purpose of this project. The signing of this title block confirms the design and drafting of this project have been prepared and checked in accordance with the AECOM quality assurance system to ISO 9001:2000.

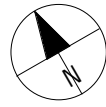

- NEW "SUPER COLUMNS"
- NEW TENSION BRACING
32mm REID BRACE
(4 LEVELS OF BRACING)

NOTES
REFER TO DRAWING 601
FOR COLUMN DETAILS.

PROJECT MANAGEMENT INITIALS

MC	NR	CO
DESIGNER	CHECKED	APPROVED

ISSUE/REVISION

-	18/4/2016	ISSUED FOR PRICING
I/R	DATE	DESCRIPTION

KEY PLAN

PROJECT NUMBER

60439900

SHEET TITLE

NEW COLUMN LAYOUT
LEVEL 0 TO 4

SHEET NUMBER

60439900-DRG-302

EXISTING FLOOR 1

Scale: 1 : 150

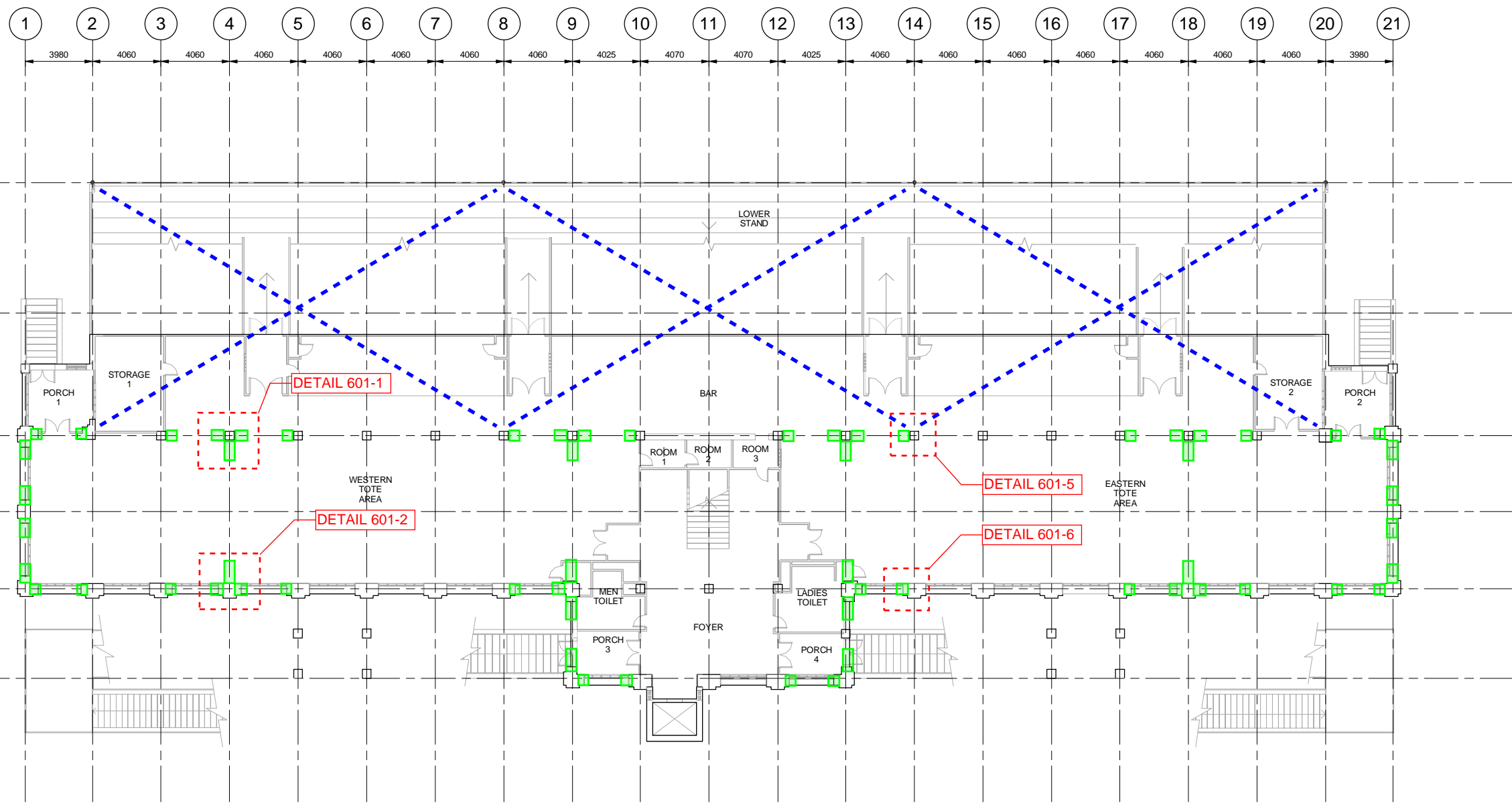

This drawing is confidential and shall only be used for the purpose of this project. The signing of this title block confirms the design and drafting of this project have been prepared and checked in accordance with the AECOM quality assurance system to ISO 9001-2000.

ISO A1 594mm x 841mm
Last Saved: 10/05/2016 2:37:50 p.m.
Filename: C:\Users\pattic\Desktop\60439900_DRG_2014_Pattic(Recovery).nrt

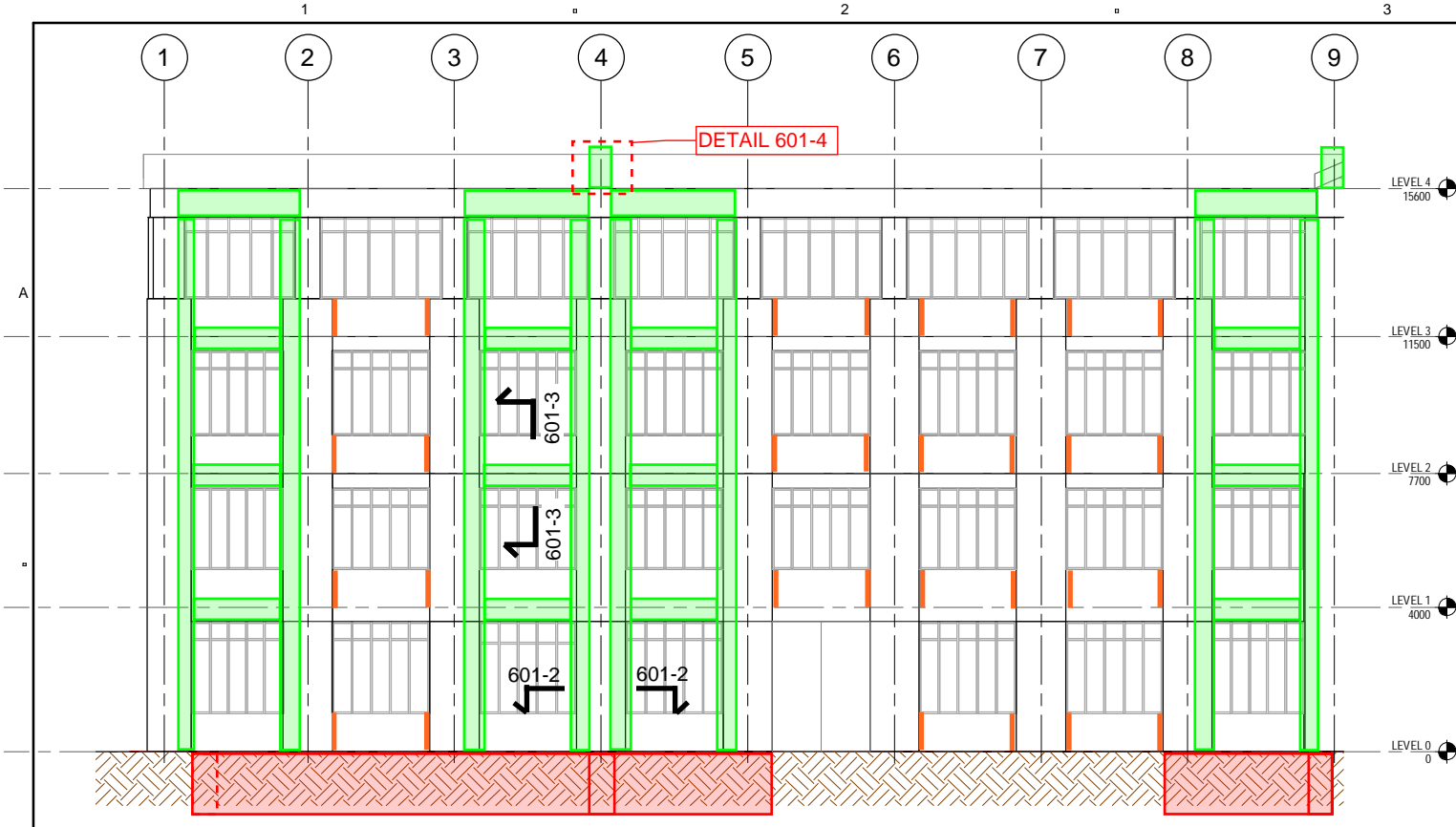

2 | SECTION ON GRID D - GRID 1 TO GRID 9
A.131 REF: A.131 Scale: 1 : 100

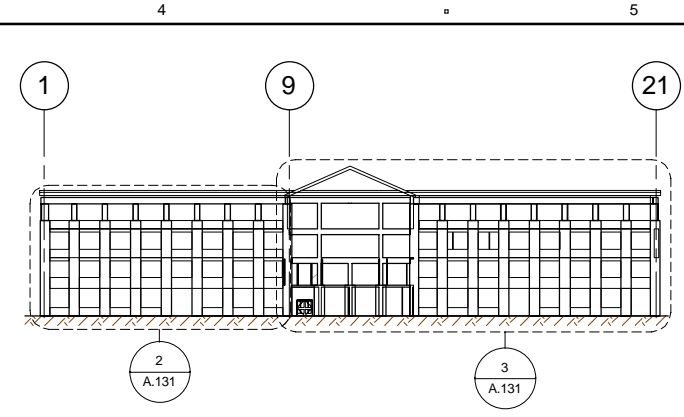

1 | SECTION ON GRID D
A.131 REF: A.100 Scale: 1 : 500

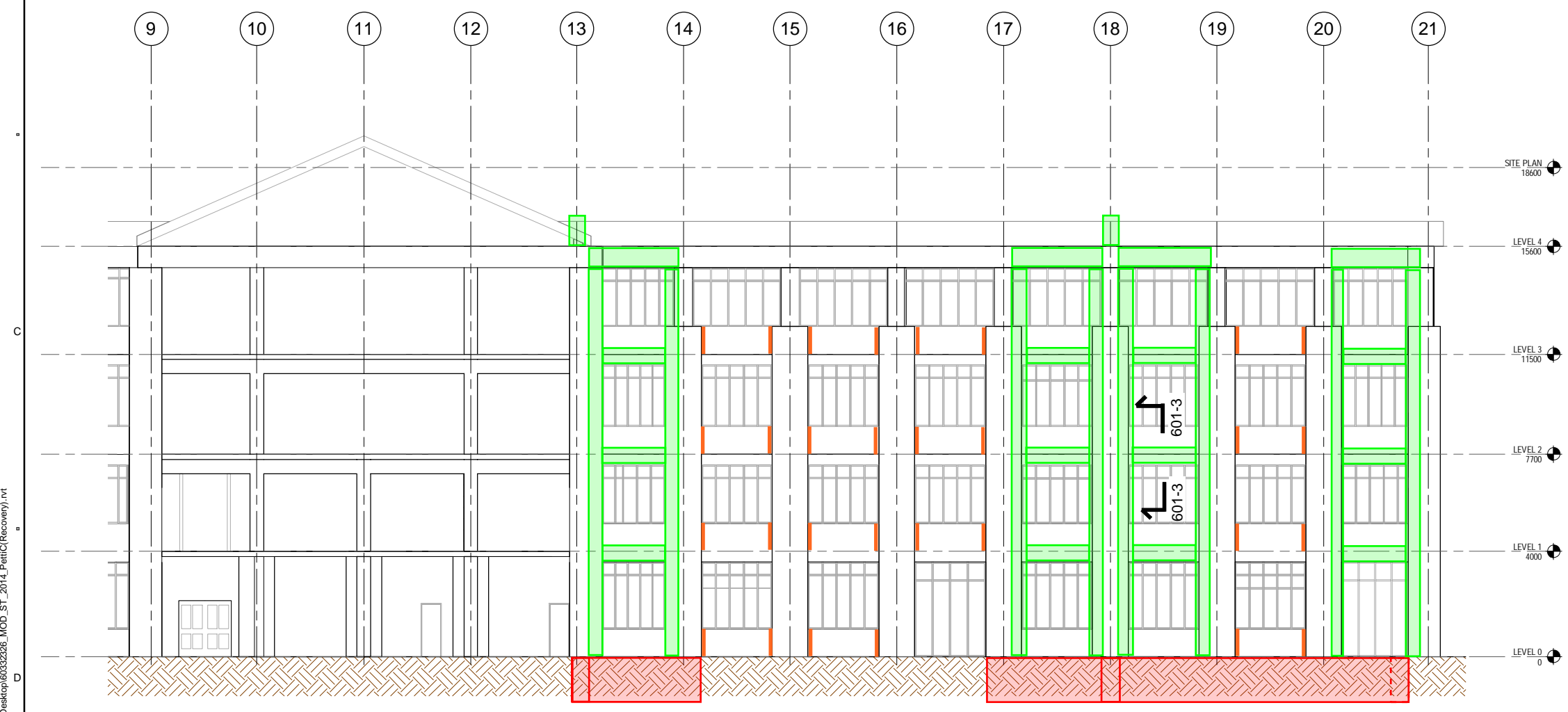

3 | SECTION ON GRID D - GRID 9 TO GRID 21
A.131 REF: A.131 Scale: 1 : 100



PROJECT
GRAND NATIONAL
STAND
CONCEPTUAL
RETROFIT SCHEME
CANTERBURY JOCKEY CLUB,
CHRISTCHURCH

CLIENT
CANTERBURY
JOCKEY CLUB

CONSULTANT
AECOM New Zealand Limited
2 Hazeldean Rd, Addington
Christchurch, NZ 8024
+64 3 966 6000 tel +64 3 966 6001 fax
www.aecom.com

- NEW FOUNDATION BEAM
- NEW "SUPER COLUMNS" AND BEAMS
- SAW CUTS TO ALL SPANDREL BEAMS ADJACENT TO COLUMNS

NOTES
REFER TO DRAWINGS 601 AND 602 FOR COLUMNS AND BEAMS DETAILS.

PROJECT MANAGEMENT INITIALS

MC	NR	CO
DESIGNER	CHECKED	APPROVED

ISSUE/REVISION

I/R	DATE	DESCRIPTION
-	18/4/2016	ISSUED FOR PRICING

KEY PLAN

PROJECT NUMBER
60439900

SHEET TITLE
SECTION - SHEET 1
GRIDLINE D

SHEET NUMBER
60439900-DRG-501

This drawing is confidential and shall only be used for the purpose of this project. The signing of this title block confirms the design and drafting of this project have been prepared and checked in accordance with the AECOM quality assurance system to ISO 9001:2000.

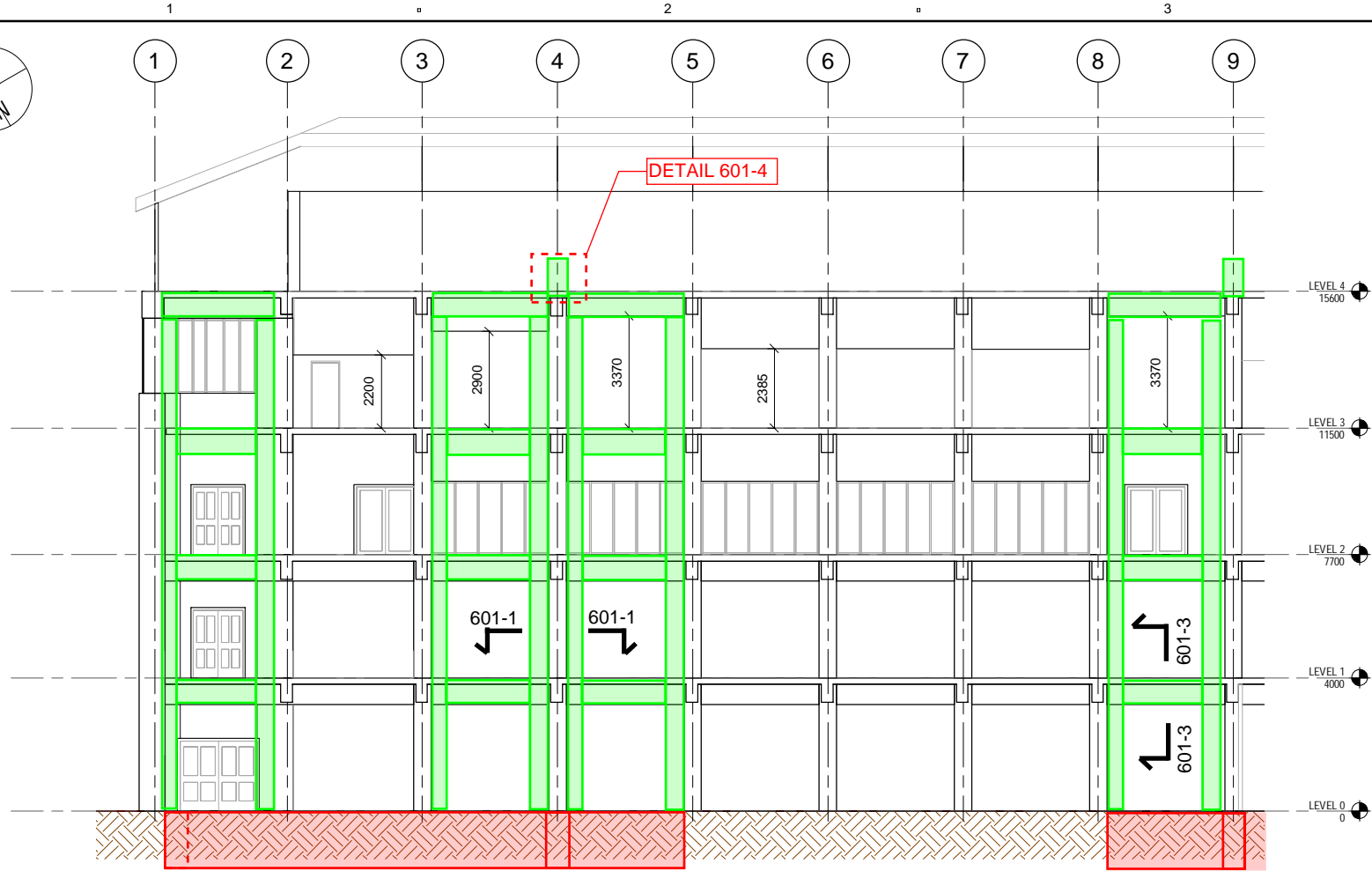
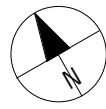

2 | SECTION ON GRID C - GRID 1 TO GRID 9
A.130 REF: A.130 Scale: 1 : 100

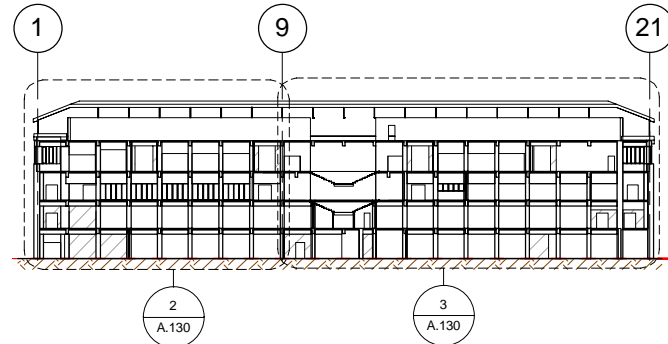

1 | SECTION ON GRID C
A.130 REF: A.100 Scale: 1 : 500

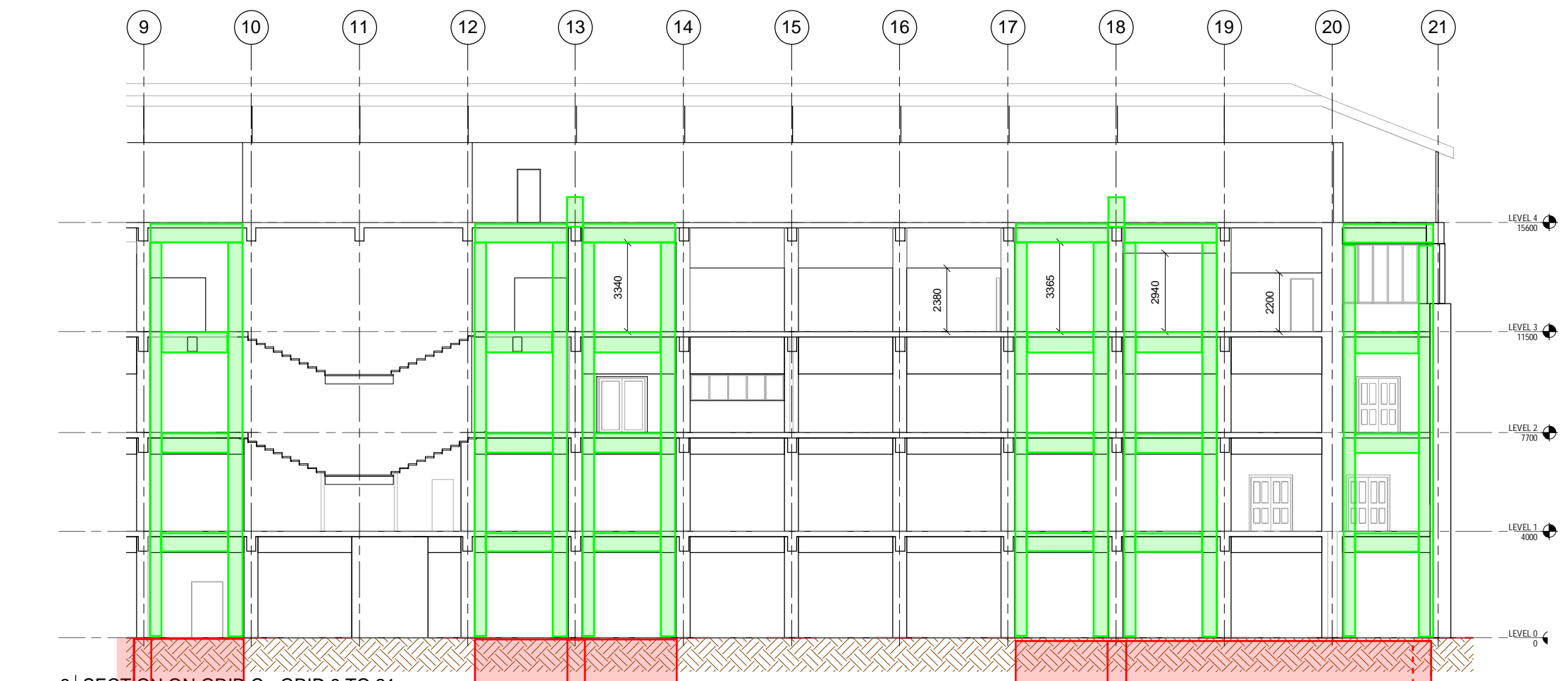

3 | SECTION ON GRID C - GRID 9 TO 21
A.130 REF: A.130 Scale: 1 : 100

- NEW FOUNDATION BEAM
- NEW "SUPER COLUMNS" AND BEAMS
- SAW CUTS TO ALL SPANDREL BEAMS ADJACENT TO COLUMNS

NOTES
REFER TO DRAWINGS 601, 602 AND 603 FOR COLUMNS AND BEAMS DETAILS.

PROJECT MANAGEMENT INITIALS

MC	NR	CO
DESIGNER	CHECKED	APPROVED

ISSUE/REVISION

I/R	DATE	DESCRIPTION
-	18/4/2016	ISSUED FOR PRICING

KEY PLAN

PROJECT NUMBER

60439900

SHEET TITLE

SECTION - SHEET 2
GRIDLINE C

SHEET NUMBER

60439900-DRG-502

SECTION ON GRIDS 4 & 18

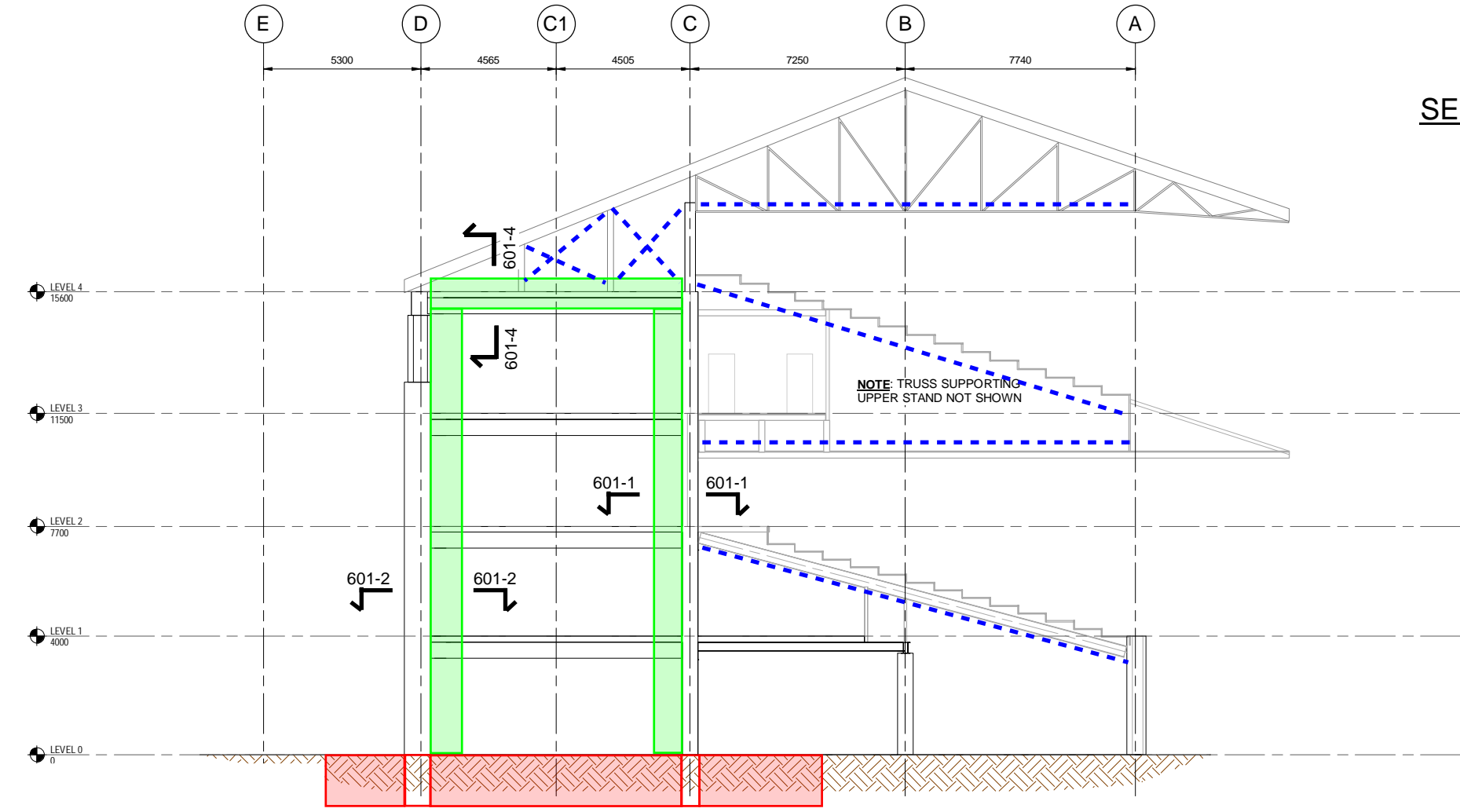

- NEW FOUNDATION BEAM
- NEW "SUPER COLUMNS" AND BEAMS
- NEW TENSION BRACING 32mm REID BRACE

NOTES
 REFER TO DRAWINGS 601, 602 AND 603 FOR COLUMNS AND BEAMS DETAILS.

SECTION ON GRIDS 9 & 13

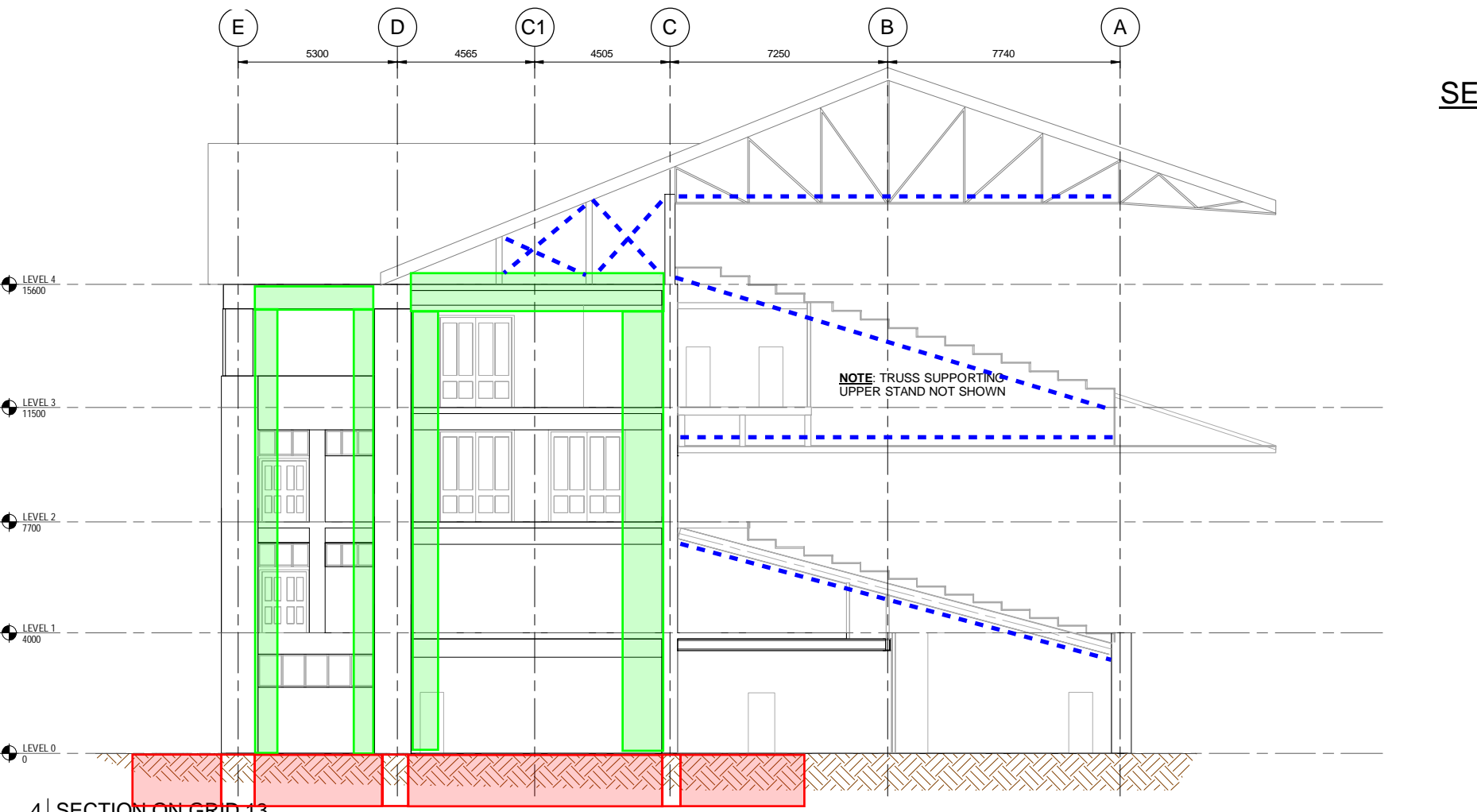

PROJECT MANAGEMENT INITIALS

MC	NR	CO
DESIGNER	CHECKED	APPROVED

ISSUE/REVISION

I/R	DATE	DESCRIPTION
-	18/4/2016	ISSUED FOR PRICING

KEY PLAN

PROJECT NUMBER

60439900

SHEET TITLE

SECTION - SHEET 3
 TRANSVERSE SECTION

SHEET NUMBER

60439900-DRG-503

ISO A1 594mm x 841mm
Last Saved: 1/07/2015 11:02:17 a.m.
Filename: C:\Users\pattic\Desktop\6032226_MOD_ST_2014_Pattic(Recovery).rvt

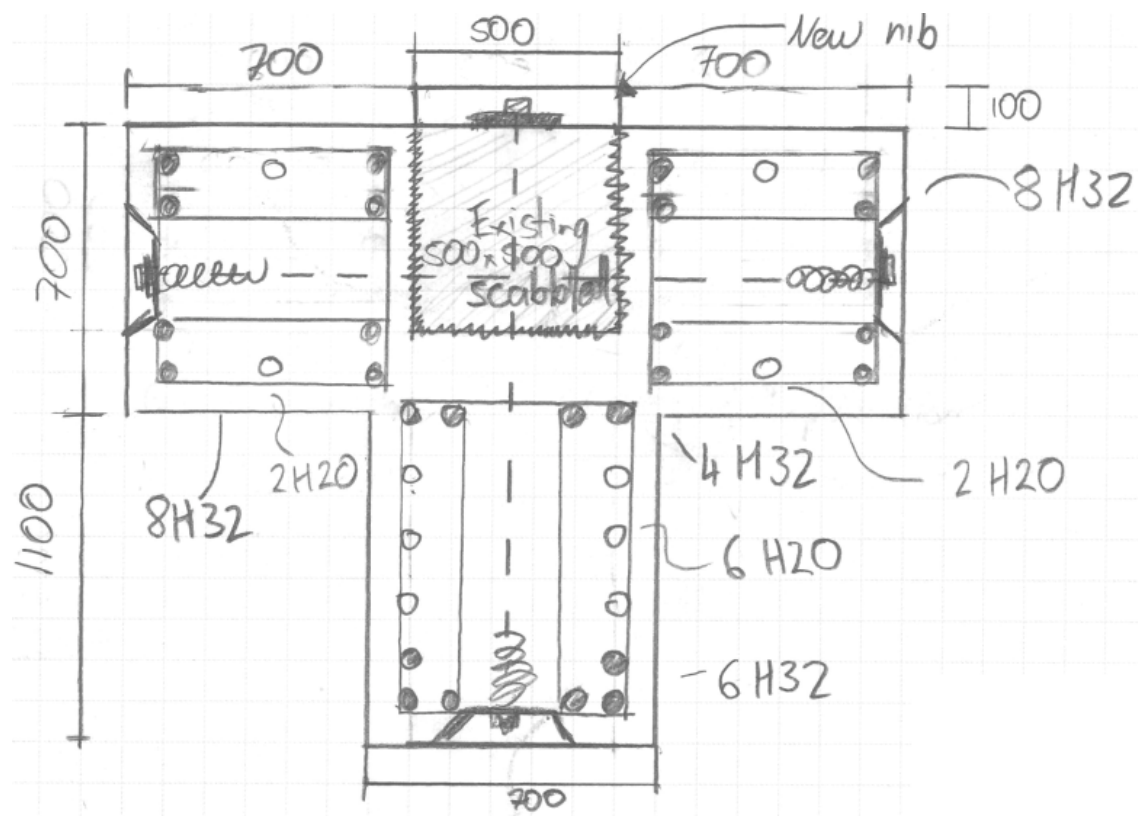

DETAIL 601-1
COLUMN ON GRIDS C-4,C-9,C-13,C-18
(N.T.S.)

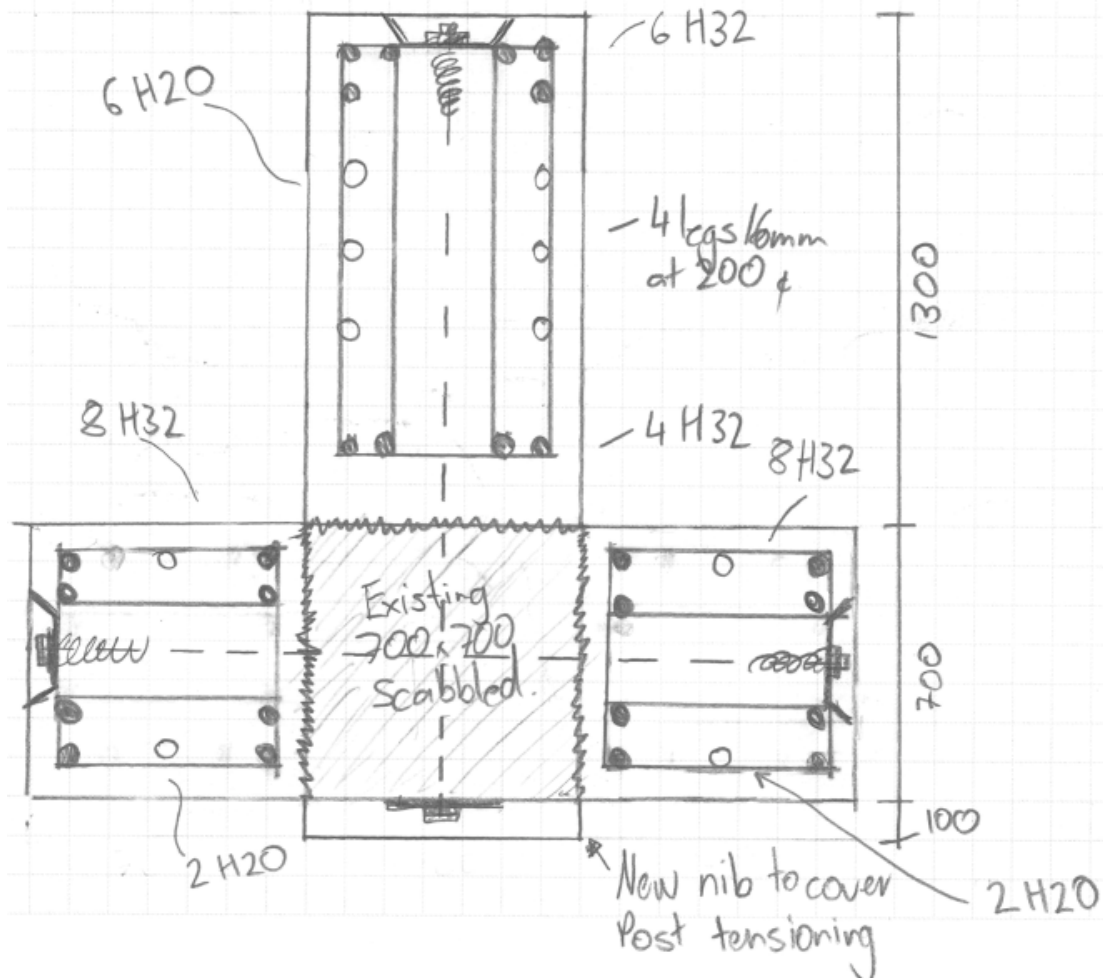

DETAIL 601-2
COLUMN ON GRIDS D-4,D-9,D-13,D-18
(N.T.S.)

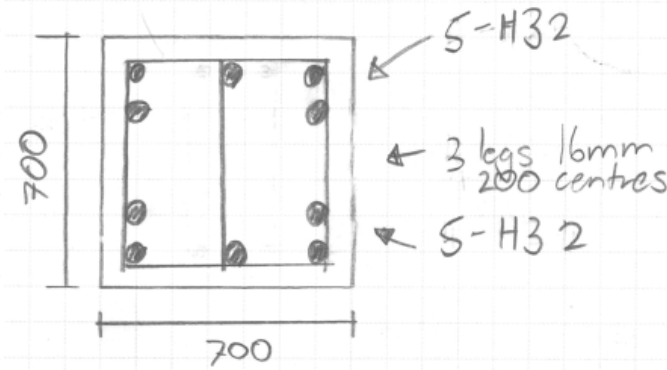

DETAIL 601-3
BEAM ON GRIDS C & D
(N.T.S.)

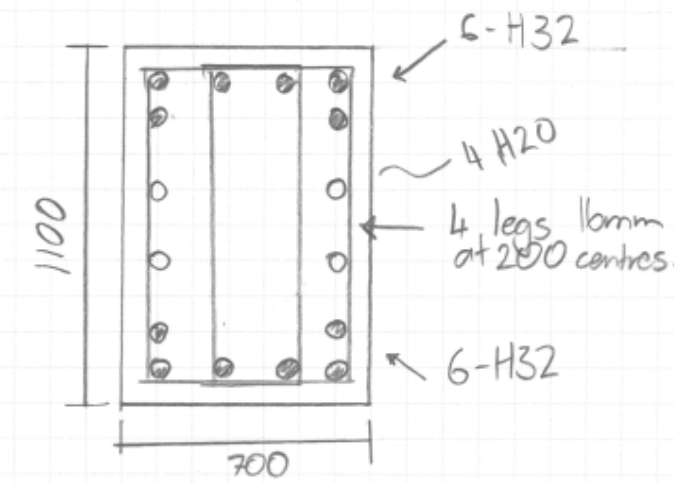

DETAIL 601-4
BEAM ON GRIDS 4, 9, 13 AND 18
LEVEL 4 ONLY (TRANSVERSE)
(N.T.S.)

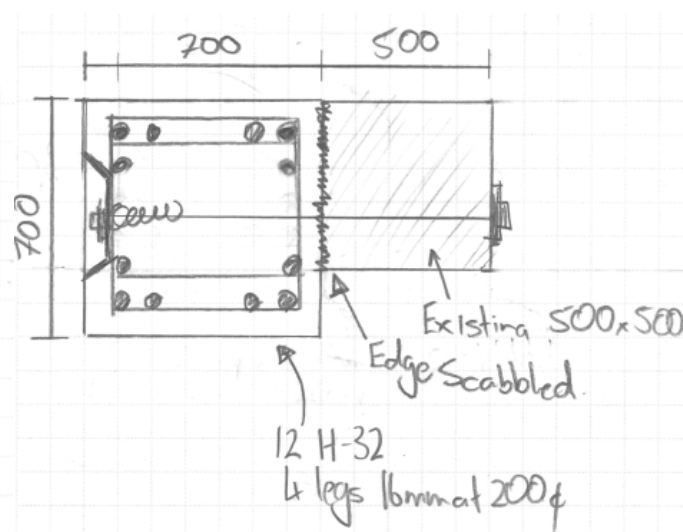

DETAIL 601-5
COLUMN ON GRIDS C-2, C-3, C-5,
C-8, C-10, C-12, C-14, C-17, C-19, C-20
(N.T.S.)

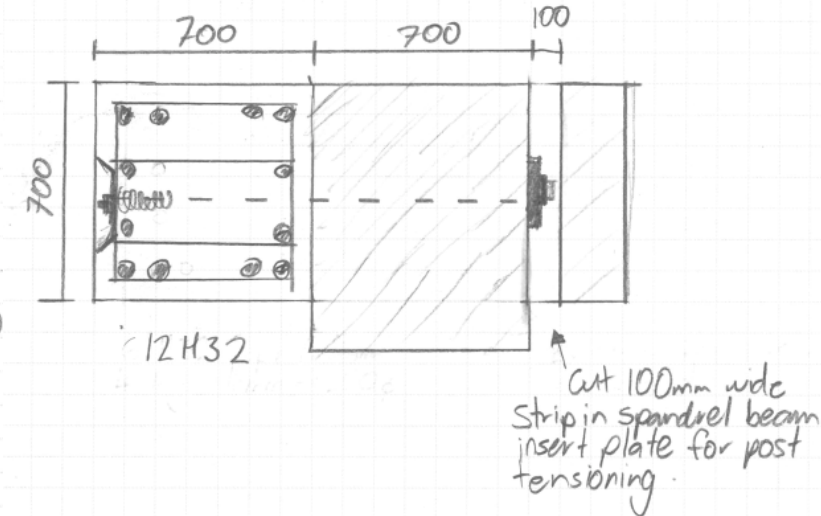

DETAIL 601-6
COLUMN ON GRIDS D-2, D-3, D-5,
D-8, D-14, D-17, D-19, D-20
(N.T.S.)

- NOTES:
1. ALL BARS TO BE COUPLED.
USE ANCON BT COUPLERS OR
SIMILAR. NO LAPPED SPLICES
TO BE USED.
2. COUPLERS TO BE
STAGGERED ALONG THE
HEIGHT.
3. REINFORCEMENT BARS
500MPa
4. REFER TO 602-1 FOR POST-
TENSIONING DETAIL.

PROJECT MANAGEMENT INITIALS

MC	NR	CO
DESIGNER	CHECKED	APPROVED

ISSUE/REVISION

I/R	DATE	DESCRIPTION
A	22/4/2016	ISSUED FOR PRICING
-	18/4/2016	ISSUED FOR PRICING

KEY PLAN

This drawing is confidential and shall only be used for the purpose of this project. The signing of this title block confirms the design and drafting of this project have been prepared and checked in accordance with the AECOM quality assurance system to ISO 9001:2000.

ISO A1 594mm x 841mm

Post-Tensioning

- See details for columns with Post tensioning
- Macalloy 1030 Post tensioning Bars 40mm
- 600mm centres
- Alternating tensioning end
- Column widthline D/4, 9, 13, 13 c/4, 13, 9, 13, post tensioned both directions, as per detail.
- Corner column widthline D/1, 9, 13, 21 c/1, 9, 13, 21 tensioned both directions
- Remaining columns post-tensioned one direction

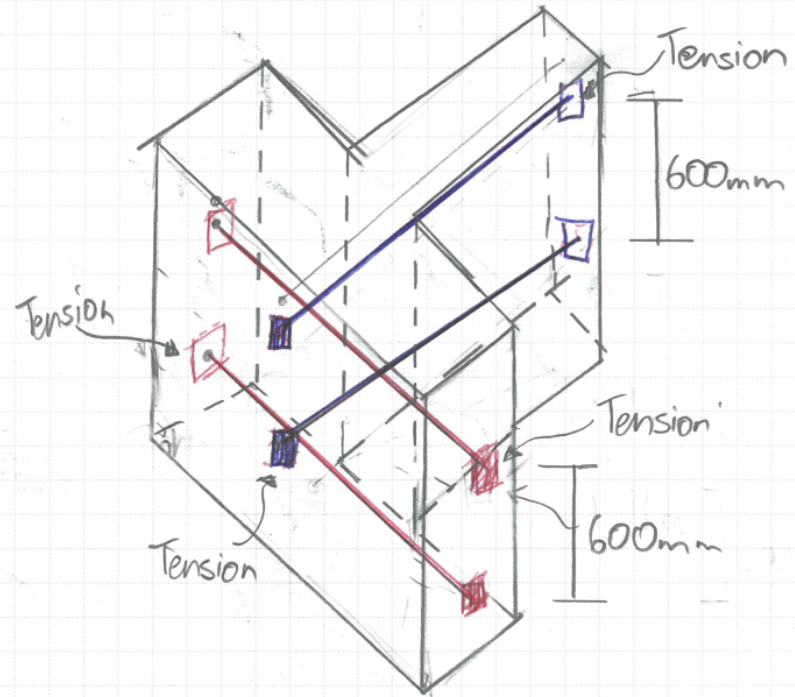

- Post tensioning NS direction
 - Post tensioning EW direction

DETAIL 602-1
POST-TENSIONING OF COLUMNS
 (N.T.S.)

Foundation Beam Typical

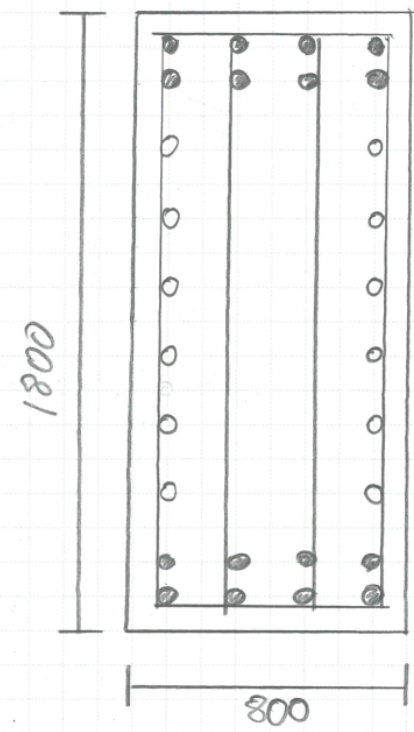

8 H32 Top & Bottom
 6 H20 each side
 4 legs 20mm at 200φ

DETAIL 602-2
FOUNDATION BEAM
TYPICAL SECTION
 (N.T.S.)

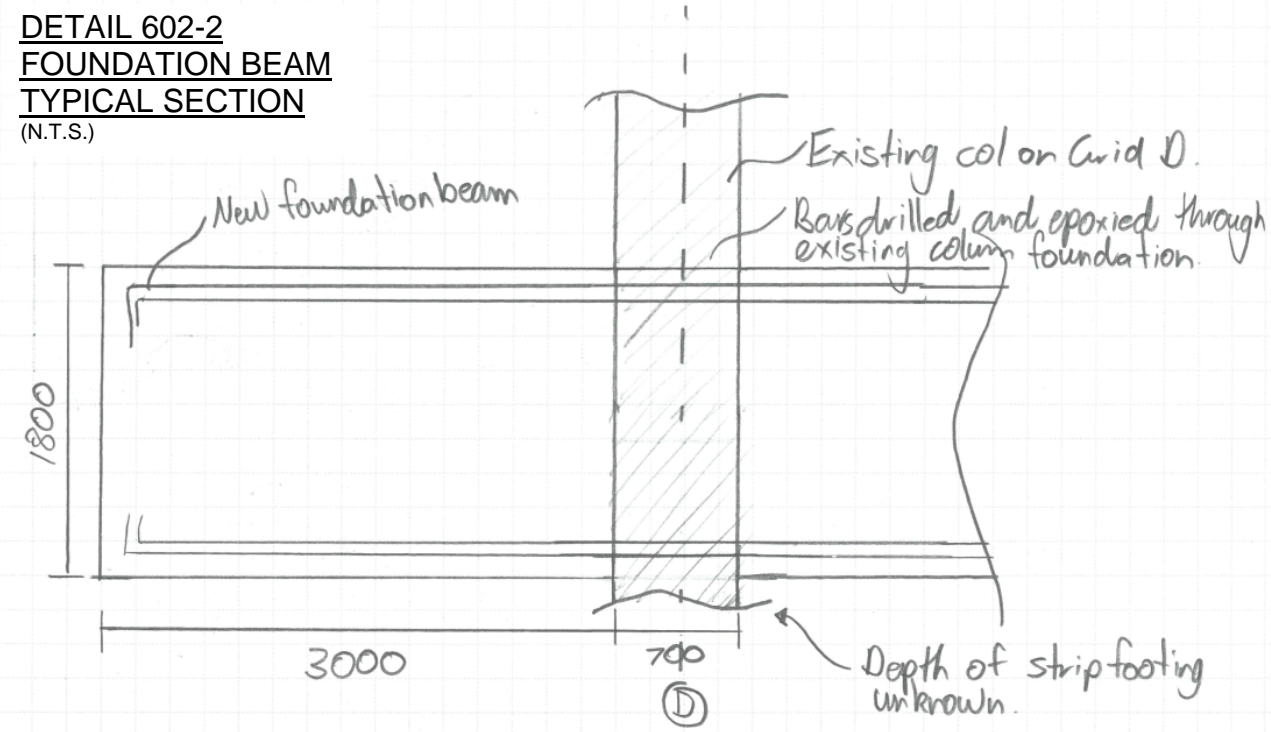

DETAIL 602-3
FOUNDATION BEAM
EXTENSION BEYONS BUILDINGS FOOTPRINT
 (N.T.S.)

PROJECT MANAGEMENT INITIALS

MC	NR	CO
DESIGNER	CHECKED	APPROVED

ISSUE/REVISION

I/R	DATE	DESCRIPTION
-	18/4/2016	ISSUED FOR PRICING

This drawing is confidential and shall only be used for the purpose of this project. The signing of this title block confirms the design and drafting of this project have been prepared and checked in accordance with the AECOM quality assurance system (ISO 9001:2000).

PROJECT MANAGEMENT INITIALS

MC	NR	CO
DESIGNER	CHECKED	APPROVED

ISSUE/REVISION

I/R	DATE	DESCRIPTION
-	18/4/2016	ISSUED FOR PRICING

KEY PLAN

This drawing is confidential and shall only be used for the purpose of this project. The signing of this title block confirms the design and drafting of this project have been prepared and checked in accordance with the AECOM quality assurance system to ISO 9001:2000.

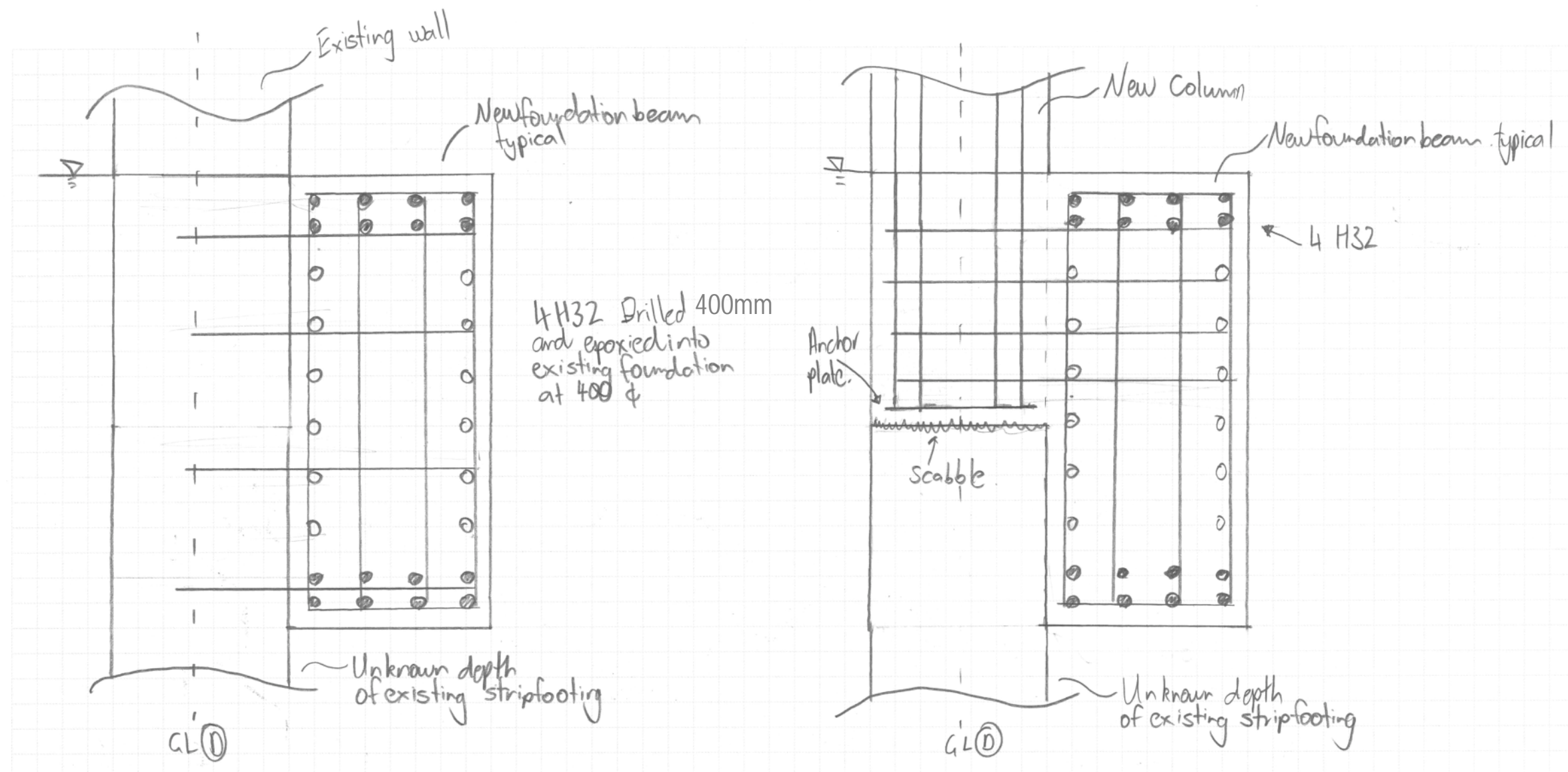

DETAIL 603-1
NEW FOUNDATION BEAM TO EXISTING SECTION BETWEEN COLUMNS
 (N.T.S.)

DETAIL 603-2
NEW FOUNDATION BEAM TO EXISTING SECTION @ COLUMN LOCATION
 (N.T.S.)